

# 21<sup>st</sup> CENTURY SCIENCE & TECHNOLOGY

FALL 2002

www.21stcenturysciencetech.com

\$3.50/IN CANADA \$4.50

UNITY OF SCIENCE  
AND THE MOON CULT

## Bring Back DDT!



- Lost Cities of Cambay
- World Space Congress 2002



# Expand your world view with

## 21<sup>st</sup> CENTURY SCIENCE & TECHNOLOGY



NASA

Artist's view of NASA's Mars 2003 Rover as it sets off to roam the surface of the red planet.

### Subscriptions

U.S.—6 issues for \$25

Foreign—6 issues for \$50

### Books

*The Holes in the Ozone Scare:*

*The Scientific Evidence*

*That the Sky Isn't Falling*

by Rogelio A. Maduro and  
Ralf Schauerhammer

\$15 each, plus \$3 shipping

OR \$10 postpaid with a subscription

*How We Got to the Moon:*

*The Story of the German Space*

*Pioneers*

by Marsha Freeman

\$15 each, plus \$3 shipping

OR \$10 postpaid with a subscription

*Global Warming:*

*The Rest of the Story*

by Dr. Gerd Weber

\$11 each, postpaid

OR \$8 postpaid with a subscription

*Hermann Oberth:*

*The Father of Space Flight*

by Boris V. Rauschenbach

\$15 each, plus \$3 shipping

OR \$12 postpaid with a subscription

## Give 21st Century subscriptions and gifts

### ORDER FORM

Enclosed is \$\_\_\_\_\_ for:

\_\_\_\_ 6 issues/ U.S.— \$25

\_\_\_\_ 6 issues/ foreign airmail—\$50

\_\_\_\_ 12 issues/ U.S.—\$48

\_\_\_\_ 12 issues/ foreign—\$98

\_\_\_\_ \$10 for *The Holes in the Ozone Scare* with a subscription

\_\_\_\_ \$18 postpaid for *The Holes in the Ozone Scare*

\_\_\_\_ \$10 for *How We Got to the Moon* with a subscription

\_\_\_\_ \$18 postpaid for *How We Got to the Moon*

\_\_\_\_ \$8 for *Global Warming* with a subscription

\_\_\_\_ \$11 postpaid for *Global Warming*

\_\_\_\_ \$12 for *Hermann Oberth* with a subscription

\_\_\_\_ \$18 postpaid for *Hermann Oberth*

Please print or type name and address of gift recipients on a separate paper. Gift cards are available.  
Note: Back issues are available at \$5 each (\$8 foreign)

Name \_\_\_\_\_

Address \_\_\_\_\_

City \_\_\_\_\_ State \_\_\_\_\_ Zip \_\_\_\_\_

Daytime telephone ( \_\_\_\_\_ ) \_\_\_\_\_ e-mail \_\_\_\_\_

Send check or money order (U.S. currency only) to:

**21st Century**, P.O. Box 16285, Washington, D.C. 20041.

[www.21stcenturysciencetech.com](http://www.21stcenturysciencetech.com)

# 21<sup>st</sup> CENTURY SCIENCE & TECHNOLOGY

Vol. 15, No. 3

Fall 2002

## Features

16

### Mosquitoes, DDT, and Human Health

*J. Gordon Edwards, Ph.D.*

A leading entomologist describes the death and suffering caused by insect-borne diseases, and tells why we must bring back DDT.

33

### To Control Malaria, We Need DDT

A malaria-control specialist explains why house-spraying with DDT is the only effective method for combatting malaria today.

35

### 9,000-Year-Old Cities Beneath the Gulf of Cambay?

*Ramtanu Maitra*

Dated artifacts and sonar scans suggest the existence of two lost cities off the west coast of India, larger than Boston and twice as old as ancient Sumer.

THE METHOD OF LANGUAGE DISCOVERY

38

### The Concept of Indo-European Philology

*Laurence Hecht*

40

### Gauss and Weber's Creation of the Absolute System of Units in Physics

*A.K.T. Assis, K. Reich, and K.H. Wiederkehr*

A specialist in Weber's electrodynamics, and leading biographers of Weber and Gauss, tell how Gauss's 1832 work in magnetism changed physics.



NASA

*Astronaut Andy Thomas shows Chinese President Jiang Zemin the Space Shuttle Mockup Facility at the Johnson Space Center in Houston, Oct. 23. Ironically, a week earlier, nearly all of the Chinese delegation were denied visas to the World Space Congress in Houston, on the bogus issue of "technology transfer" concerns. See p. 50 for a report on the Congress.*

## News

### IN MEMORIAM

#### 9 Col. Roy Vinson, Inventor of Magnettrain, and Julia Vinson

*Laurence Hecht*

### ASTRONOMY REPORT

#### 49 An Opening in Astronomy

*David Cherry*

### SPACE

#### 50 THE 2002 WORLD SPACE CONGRESS

#### Economic Collapse Threatens Prospects for Space Exploration

*Marsha Freeman*

## Departments

### EDITORIAL

#### 2 Reverend Moon and the 'Unity of Sciences' Cult

*Laurence Hecht*

### 4 LETTERS

### 10 NEWS BRIEFS

### VIEWPOINT

#### 12 Mosquito Spraying Essential To Keep America Healthy

*Joseph M. Conlon*

### BOOKS

#### 56 Great Art Requires More Than Optical Technology

*Secret Knowledge: Rediscovering the Lost Technique of the Old Masters*

by David Hockney,

Reviewed by Karel Vereycken

#### 60 How the Atomic Space Ship Bit the Dust

*Project Orion*

by George Dyson,

Reviewed by Marsha Freeman

#### 64 Adrift in Academia

*Sea Drift: Rafting Adventures in the Wake of Kon Tiki*

by P.J. Capelotti

Reviewed by Richard Sanders

On the cover: Problem: disease-carrying mosquito; solution: DDT. Cover design by Alan Yue.

# Reverend Moon and the 'Unity of Sciences' Cult

**EDITORIAL STAFF**

**Editor-in-Chief**

Laurence Hecht

**Managing Editor**

Marjorie Mazel Hecht

**Associate Editors**

Elijah C. Boyd  
David Cherry  
Marsha Freeman  
Colin M. Lowry  
Gregory B. Murphy  
Elisabeth Pascali  
Charles B. Stevens

**Books**

David Cherry

**Art Director**

Alan Yue

**Advertising Manager**

Marsha Freeman

**SCIENTIFIC ADVISORY BOARD**

Francesco Celani, Ph.D.  
Hugh W. Ellsaesser, Ph.D.  
Bertha Farfán, M.D.  
James Frazer, Ph.D.  
John Grauerholz, M.D.  
Emmanuel Grenier  
Lyndon H. LaRouche, Jr.  
Wolfgang Lillge, M.D.  
Ramtanu Maitra  
Thomas E. Phipps, Jr., Ph.D.  
B.A. Soldano, Ph.D.  
Jonathan Tennenbaum, Ph.D.

**21st Century Science & Technology** (ISSN 0895-6820) is published 4 times a year in 2000, every third month, by 21st Century Science Associates, 60 Sycolin Road, Suite 203, Leesburg, Va. 20175. Tel. (703) 777-7473.

Address all correspondence to **21st Century**, P.O. Box 16285, Washington, D.C. 20041.

Second-class postage is paid at Leesburg, Va. and additional mailing offices.

**21st Century** is dedicated to the promotion of unending scientific progress, all directed to serve the proper common aims of mankind.

Opinions expressed in articles are not necessarily those of 21st Century Science Associates or the scientific advisory board.

We are not responsible for unsolicited manuscripts.

Subscriptions by mail are \$25 for 6 issues or \$48 for 12 issues in the USA and Canada. Airmail subscriptions to other countries are \$50 for 6 issues. Back issues are \$5 each (\$6 foreign). Payments must be in U.S. currency.

POSTMASTER: Send address changes to 21st Century, P.O. Box 16285, Washington, D.C. 20041-0285.

Copyright © 2002

21st Century Science Associates

Printed in the USA ISSN 0895-682

www.21stcenturysciencetech.com

In 1972, the Reverend Sun Myung Moon, better known in contemporary circles as the Mephistopheles of Poontang, took over the franchise on the Unity of the Sciences movement. The latter, a cult operation as evil as Moon's, but more intellectually damaging, was founded in the mid-1930s under leadership of John Dewey, Bertrand Russell, and Otto Neurath of the Vienna Circle of logical positivists. In the 1950s, it merged with Robert M. Hutchins's University of Chicago publishing operations to become the International Encyclopedia of Unified Science. Thomas S. Kuhn's *The Structure of Scientific Revolutions* was one of its more successful ventures.

It would be wrong to suppose that the many Nobel Prize-winners and other leading scientists, who have graced the dais at the annual Reverend Moon-sponsored International Conferences on the Unity of the Sciences, were merely taking advantage of a nice honorarium and a chance to sound off in public.

Some, like physicist Eugene Wigner, for example, or the neurophysiologist, Lord Edgar Douglas Adrian, were perfectly witting in what they were about. Much more so, than the psychologically damaged Korean preacher, who calls his religious vision in a North Korean torture cell "my brainwashing," and never misses a chance to remind his audiences that the highest truth is that the male and female sex organs fit together—"unity." (Yes, he would be a joke, were it not for the fact that he owns, or is right now buying up, a good chunk of the U.S. Congress, the President of the United States, and a spectrum of religious figures from Jerry Falwell to Louis Farrakhan—paid for by the flow of dirty money from the drugs and arms trade that has financed the rise to prominence of the Moon cult.)

It is only possible to make sense of the

curious marriage of the Reverend Moon with the leadership of world science, by taking a step back in history to examine some developments which will strike the typically miseducated college graduate as rather strange. We will be publishing the full case in the near future. We have only the space here for the short version. Every word we write is carefully researched and documented. So pay attention, and keep an open mind. If you should discover that your college education was largely a consumer fraud, there will be plenty of time later to bring the lawsuit.

The Moon cult and the Unity of the Sciences Movement are two operations spun out of a London thinktank in the early part of the 20th century, known variously as the Coefficients Club, the Roundtable, and Milner's Kindergarten. Leading strategists included Lord Robert Cecil, Lord Alfred Milner, Leo Amery, Halford Mackinder, H.G. Wells, and Lord Bertrand Russell. The problem facing them was how to maintain the power of a maritime-based, financier oligarchy, in a world threatened by the growing industrial strength of the United States, Germany, France, and Japan. World War I was their first big project; the failed League of Nations the second.

**The Program**

In 1928, their propagandist Wells, issued the program of the grouping in a book titled *The Open Conspiracy*. The plan, openly discussed, was to create a "new world religion" that would channel the power of self-sacrifice, characteristic of religious zeal, into implementing the goals of the conspiracy. These were, as summarized by Wells:

"Firstly, the entirely provisional nature of all existing governments, and the entirely provisional nature, therefore, of all loyalties associated therewith:

"Secondly, the supreme importance of population control in human biology and the possibility it affords us of a release from the pressure of the struggle for existence on ourselves; and

"Thirdly, the urgent necessity of protective resistance against the present traditional drift towards war."

The first action of the "Open Conspiracy" was to be the cultivation of a mass-based peace movement. It began at Oxford University, and spread among student populations in Europe and the U.S.A. in the 1930s, in the form of a solemn, signed pledge never to participate in any war, and refuse service if drafted.

The organizer of the movement, which later became known as Moral Re-Armament, was an American preacher turned British intelligence agent, named Frank Buchman. He was an ardent admirer of Hitler, and included Gestapo chief Himmler and Rudolf Hess in his membership lists. But Buchman was also supported by the Archbishop of Canterbury, and included Edward VIII, when he was Prince of Wales, as a member. In the U.S.A., his pre-war supporters included movie mogul Louis Mayer, *Los Angeles Times* publisher Harry Chandler, and David Dubinsky of the International Ladies Garment Workers Union.

After World War II, Buchman's Moral Re-Armament emerged as a major cold war vehicle, particularly in Western Europe and the Far East. His 1949 conference in Switzerland was attended by European parliamentarians and a bipartisan delegation of the U.S. Congress, flown in by military aircraft.

Moon's Korean ministry got plugged into Moral Re-Armament at the time of the Korean War, or before. After the war, the small Moon operation was picked up by military intelligence circles connected with the notorious MK-ultra program for psychedelic drug experimentation, and Tavistock-originated group dynamics programs for social manipulation. He was set up in the United States,



*The Reverend Sun Myung Moon, known to some as the Mephistopheles of Poontang.*

under highest level intelligence cover, in the early to middle 1960s.

#### The Cult of Science

Apart from the mass peace movement, the other side of the Open Conspiracy involved science in two ways:

*First*, to build a weapon of mass destruction so terrible it could be used to force nations to forego their sovereignty. Wells's Hungarian disciple, physicist Leo Szilard, played the leading role in this. Szilard was the real-life model for Dr. Strangelove in Stanley Kubrick's famous film of that name, and also the lifelong friend and political adviser to Eugene Wigner.<sup>1</sup>

*Second*, to turn biology from the science of life into a branch of inorganic physics.<sup>2</sup>

To accomplish this, it was necessary to first degrade the scientist's conception of himself. Another member of the Coefficients Club, Lord Bertrand Russell, played the key role in this. Russell was a product of the Cambridge Aristotelian Society. His early career was built on an absurdly incompetent attack on philosopher Gottfried Leibniz<sup>3</sup> and Carl Friedrich Gauss's greatest student, Bernhard Riemann. The essence of it all

was to prove that universal genius was impossible, human creativity did not exist, and the mind is only a collection of logical elements (which artificial intelligence would later attempt to replicate out of electronic spare parts).

Russell's dilettantish excursions into philosophy were consistent with the program of the Machian-influenced logical positivism of the Vienna Circle, and John Dewey's pragmatism. The denial of the synthetic *a priori*, i.e. creativity, and consequent reduction of all knowledge to mere logical formalism, is the common feature of both systems.

In 1935, refugee members of the logical positivist Vienna Circle joined with a collection of American Trotskyists grouped around John Dewey in the first meetings of the Unity of Sciences movement in New York. At a 1938 meeting at the University of Pennsylvania, with Russell in attendance, the Unity of Sciences movement was launched in earnest.

This was the operation that the Reverend Moon's Unification Church incorporated under its wing in 1972.

Dr. Strangelove, meet the Reverend Moon.

—Laurence Hecht

#### Notes

1. Wells had already foreseen the use of an atomic weapon in a 1913 work of fiction, based on physical chemist Frederick Soddy's 1908 *The Interpretation of Radium*. Its realization was made possible by the collaboration of Szilard and Eugene Wigner in winning Einstein's backing for a letter urging President Roosevelt to begin research on an atomic bomb, arguing with no basis in fact, that Hitler was about to develop one. Very few of the scientists working on the Manhattan Project as a patriotic duty knew that some people actually intended to find a way to use the bomb before the war was over.
2. Niels Bohr's colleague Max Delbrück and physicist Szilard, who reinvented himself in the post-war period as a molecular biologist, were crucial players. The Cold Spring Harbor Laboratory, founded by Harriman family funding in the 1920s to promote the "perfection of the race" through eugenics, was the center of this effort in its early days.
3. Russell claimed to have comprehended all of Leibniz's philosophy under five logical premises, which he (Russell) had discovered. Finding that almost none of Leibniz's published work was consistent with the five premises, Russell decided that Leibniz was lying about what he really believed.



## Barry Fell Disputed

### To the Editor:

Your authors continue to promote Barry Fell's ideas about ancient scripts and languages and associated claims about early human history, as summarized by Julian Fell. In the Winter 2001-2002 issue, for example, these ideas feature in articles and comment on pp. 5-7 (Coleman, J. Fell [letter to editor and reply]), pp. 6-7 (LaRouche ["Metalingual Decipherment: The Implications of Sumerian"], and pp. 54-58 (Perfect ["Pitcairn Island Petroglyph Deciphered"])).

Your readers should appreciate that Barry Fell, a professional academic in an unrelated field, was only an amateur enthusiast in respect of historical linguistics. He was an accomplished language-learner and taught himself very many facts; but he never demonstrated genuine understanding of the discipline and in particular adopted comparative methods which have long been abandoned by linguists because they are demonstrably unreliable.

In addition, his identifications of phonetic values for symbols such as those presented by Perfect (pp. 54-55), and his decisions as to the direction in which symbols should be read are inadequately grounded. His followers have continued in the same vein. Rightly, none of this material has been accepted by the scholarly community. This is not always made clear by your authors, who have their own views, but who might at least acknowledge that virtually no one with the relevant expertise shares these views. My main goal in writing is to redress this.

Specifically:

(1) There are no accepted cases of Ogam script either (a) outside the traditional Celtic lands or (b) with the modifications proposed by Barry Fell, still less both (Coleman, p. 5).

(2) Nyland's work involves implausible, inadequately supported hypotheses

and unwarranted extrapolation from data. See my review of his book on Amazon (Coleman, p. 5).

(3) Similarities of vocabulary between languages such as Basque, Georgian, Shoshone, Tamil, etc., which appear genetically unrelated and cannot be shown to have experienced serious contact in historic times, have always been found to be (a) unsystematic, (b) not supported by shared grammatical or other structural features, and (c) within the statistically reasonable limits of chance resemblance. This means that the default analysis must be that they are accidental. I am happy to refer readers to explanations of (a), (b), and (c) (J. Fell, p. 7).

(4) The expression "the obvious functional continuity of the Sumerian cuneiform to the Sumerian culture" appears obscure, and it is thus impossible to assess what this might indicate (LaRouche, p. 6).

(5) Although Sumer quite probably had contact with Dravidian-speaking cultures, it has not been shown that it was an offshoot of any such culture (LaRouche, p. 6).

(6) The claims derived from Herodotus, who did not know of Sumer specifically, involve large amounts of extrapolation, which is not made at all clear (LaRouche, p. 7).

(7) The theory of an "Aryan Invasion" of South Asia is contentious and the matter is complex. For instance, the language written in the Indus Valley Script has not been identified; it might be Dravidian or Indo-European, (or something else again) (LaRouche, p. 7).

(8) There are no accepted cases of ancient written Dravidian outside South Asia (LaRouche, p. 7).

**Mark Newbrook**  
Senior Lecturer in Linguistics  
Monash University  
Victoria, Australia  
morcuporcus@hotmail.com

### Julian Fell Replies

Newbrook raises a number of issues that I may address. His response is classically linguistics establishment, and contains the usual flat arguments that we have dealt with for years, although it is a pleasure for once to deal with a gentleman correspondent who does not resort to personal and defamatory invectives, a

regrettably frequent occurrence.

An early claim of the linguistic establishment used to be that Barry Fell was unqualified, but they have eventually acknowledged that his language knowledge was both broad and deep. The next step was to claim that although it was in fact huge, his knowledge was unstructured and unsophisticated, as evidenced by his lack of a linguistics degree, and lacked "genuine understanding." My initial response would be to point out that a degree is not a measure of capability so much as it is proof of having attained a specified level of rote competence. It is a certification that one is inducted into the ranks of the status quo. Lacking a driver's license does not mean you cannot drive, nor does having a driver's license prove that you are an outstanding driver.

I would point out that Vallency, Champollion, Rawlinson, Ventris—in fact, most of the great epigraphers—all lacked degrees in linguistics. On the other hand, very few significant decipherments have been achieved by persons with linguistic degrees.

The etymological method of decipherment has been little used in the past, as previous decipherments have concentrated on unknown scripts for which a bilingual match had been found. The use of word roots for decipherments is required in instances where there is no bilingual match. Without the etymological method, the unknown scripts remain undeciphered. The technique was not abandoned as unreliable so much as abandoned for lack of linguists with the depth and breadth of knowledge to do the work.

Thus, Linear A, proto-Sanskrit, Etruscan, Numidian, and so on, would have remained undeciphered forever if left to the "true understanding" of conventional linguists. The techniques themselves do work, as they have been applied and tested on known living languages with good results. The methods used by Barry in the 1970s were subsequently used in the 1980s to break the Mayan hieroglyphics. I wonder what the Mayanists would think to know other linguists are calling the technique "demonstratively unreliable."

I think what irks the linguistic profession is that it is outsiders who end up doing the job, and the conclusions do not match the current prejudices of the

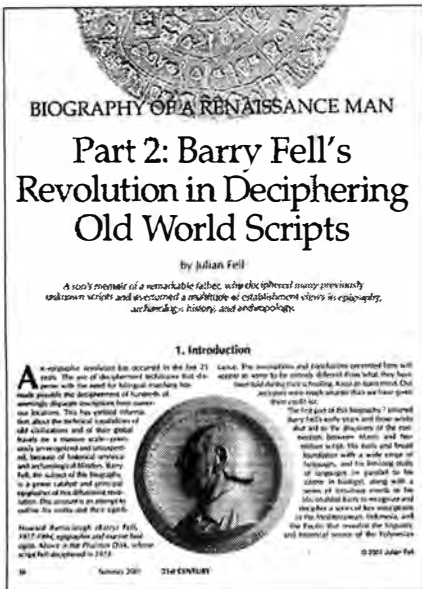

archaeologists. Ventris's work was accepted right away, not because he was a linguist but because his result fitted in with academically acceptable options, and he had obtained "permission" to investigate from the archaeological establishment.

As to non-acceptance by the scholarly community: Historically it has always taken a while for controversial results to become accepted when they contradict the established beliefs of the day. Just look at the time required for the findings of Copernicus to be accepted; look at the pressures to recant brought upon Galileo. The epigraphic findings of Vallery and Champollion met vehement scorn for decades in some places. I was particularly amused by the event that Ernest Rutherford at McGill University was asked by his fellow faculty not to publish his findings of the spontaneous transmutation of elements, for fear that it would bring disrepute, ridicule, and charges of alchemy upon their institution. The reality is that the process of introducing new ideas is not smooth, and that prejudices of the establishment are a greater barrier than comprehension and objective evaluation of the thesis.

The official line of the linguistic establishment is that there is no Ogam outside the British Isles, nor before 400 A.D. This is really an ideological dogma. There is probably more Ogam in North America than in Britain. The

longest tracts of Ogam are in West Virginia. Though widely found in North America, Ogam is not randomly distributed, but occurs in concentrations in various locations.

Newbrook makes reference to similarities of vocabulary. I agree that there is insufficient evidence to qualify a relationship between Basque, Georgian, Shoshone, and so on, and declined to discuss it further, other than to acknowledge the observation. Any two languages will have shared phonemes and syllables. When coupled together, they may even have like-sounding words. This by itself is of no significance, as it can arise easily by chance. What is important is when similar words by sound also have similar meaning (onomatopoeic words excluded). The probability of this arising by chance is extremely remote, and when there are multiples of this sharing consistently with another specific language, the probability of this arising by chance is astronomically remote.

It follows that we have to be careful to qualify ourselves when speaking of a relationship. There can be a relationship of descent deriving from a shared ancestral language (Newbrook uses the term "genetic" metaphorically but nevertheless very appropriately, as words descend like genes.) Hindustani and Urdu, two daughter languages attempting to separate themselves as much as possible, are an example of ancestrally related languages.

You can have shared vocabulary derived from contact between two ancestrally unrelated languages who still share a block of "loan words." You can also have languages unrelated ancestrally, and lacking transferred vocabulary, which still can be related by using a shared writing system. When talking of similarities of languages one must watch the semantics.

Regarding an hypothesized Dravidian regional culture, I agree that I have not seen proof. We know the Dilmun Culture of the Arabian Sea (pre-2850 B.C.) yielded artifacts indicating strong trading ties to Egypt, Sumer, Arabia, and Indus Valley, but nothing Dravidian in character. Barry Fell has shown that the Indus Valley script can be read as an ancestral form of Sanskrit. If there was a Dravidian

hegemony and an "Aryan invasion," they occurred prior to the Indus Valley civilization.

## Extrasolar Planets Questioned

### To the Editor:

I recently came upon your magazine in the library. I found some of the critical reviews and skepticism, as well as alternative ideas interesting, but was disappointed that, instead of skepticism and critical analysis, there was support for the usual pseudoscience in the methods and evidence for extrasolar planets in the Spring 2000 issue ("The Growing Evidence of Planets Beyond Our Solar System," by Marsha Freeman, pp. 46-57). Ironically, general relativity instigated many of the assumptions and conclusions that led to today's claims of exoplanet discovery.

Historical preconception about effects on a star by planetary bodies eventually led to *post hoc* bias confirmations without any scientific empirical corroboration. The article claims that scientists have known for centuries that bodies orbiting a star will produce perturbations in the relative motion of that star.

This is not entirely true, as it is arbitrary for planets. Scientists in the past observed the phenomenon of two stellar mass bodies in close proximity perturbing each other's motion. The mass differential between two stars is greatly smaller than that of a star and a planet. There is no empirical evidence for a proposition, let alone a claim of validity, that a planetary mass has any such effect on its star, or for the mathematical conjecture of planetary effects on the Sun, about circular motions, or for the cause of motion if it existed. Such reliances for extrapolation are arbitrary hubris.

The story of Sirius is circular reasoning. Sirius A is a spectral source that may be quasi-stellar. There is no evidence that Sirius A is a stellar body or a gravitational mass. Halton Arp observed quasi-stellar spectral sources that may have been ejected from the central core of AGN [active galactic nuclei] galaxies. Such phenomena could also be true for unknown states in stars.

Also, quasi-stellar emissions have been found of jet-end creations in plan-

etary nebulae. Polarized active jets with ionized and continuously energized diffuse lumps, the jets sometimes not of themselves visible, are thought to cause observational illusion of apparent though not actual gravitational mass.

The actual physical properties and origin of Sirius A are still unknown today. This is true for other such observations. The spectral effects observed of the star Sirius are of unknown causes, which is due to our ignorance of all stellar states relative to the phenomena observed, and scant data. Anyone calling Sirius A a "white dwarf star" and gravitational body is entirely arbitrary, lacking scientific corroboration to this day. The conclusions, both past and present, about those observations are not worthy from which to claim a valid cause-and-effect relationship, let alone to call it evidence for planets.

"Astrometric displacement" has no scientific corroboration that it exists relative to planetary mass effects on a stellar mass. "Transit," also an arbitrary term and meaning, is not known to be motion from a gravitational body of any kind, let alone a planet. "Gravitational lensing," an arbitrary term and conclusion, has no empirical scientific corroboration of existence at all or of a "gravitational" cause. Doppler effects do not identify a gravitational body as its cause, nor any properties of its cause; thus is not scientific evidence of a planet. No method or technique claimed to have any factual accuracy has ever been tested with factual accuracy. Meanwhile claims of discovery are myth—not science. Today there is no legitimate scientific evidence whatsoever of extrasolar planets.

While planetary formation as a by-product of star formation is a plausible postulate, there are no known planets existing around other stars, nor is there any empirical evidence that past documentation of an observation of spectral anomalies has any meaning of "planet."

After reading the skeptical reviews of some theoretical concepts in the other issues of your magazine the library had, the nonskeptical and uncritical acceptance of the methods and claims in the aforementioned article is bewildering. There appears to be a self-contradiction. Would you care to explain?

**Miles A. White III**  
Wheat Ridge, Colorado

## The Growing Evidence Of Planets Beyond Our Solar System

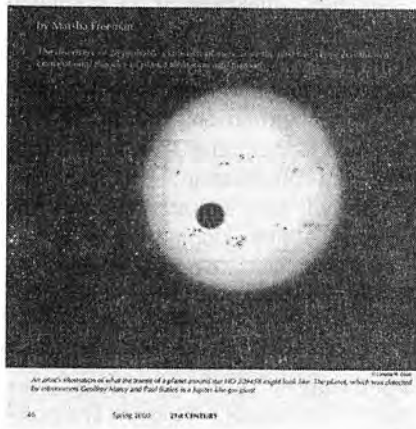

### The Editor Replies

We sent your letter to two of the planet hunters mentioned in the article you cite. They declined to answer it, arguing that your letter questioned so many basic premises of the astronomy involved that they could not retrace and validate their steps in a short answer.

Without agreeing with all your points, we find this attitude mistaken. Science is hypothesis. To explain the assumptions upon which one works to a nonspecialist can be difficult, but is always useful. Although the details may be complicated, it should always be possible to explain the essential hypotheses in a brief and cogent manner. This is especially necessary in an area such as this, where the results are controversial.

We have asked Astronomy Editor David Cherry to reply.

### David Cherry Replies

My first reaction to your letter was to agree that we could not say, that even one extrasolar planet had been proven. On looking back at what Marsha Freeman wrote, however, I reached a conclusion that had escaped me before: that for HD 209458, we can say, "it has a planet." I will get to that. But the main point is, that the planet hunters are on a trajectory of technological advances that will resolve our doubts.

I am not sure we agree on what "empirical corroboration" would mean.

It is not necessary, nor even possible, that we see, hear, smell, feel, or taste a phenomenon to know of its existence, since knowing is a *cognitive* process.

The work that is now being done identifies stars with alternating redshifts and blueshifts of well-defined periodicities. These are then *assumed* to result from to-and-fro perturbations ("wobble") caused by one or more massive planets orbiting the star.

I am not aware of overestimation—to which you allude—of the *amount* of perturbation of stars by planets. It is commonly said that the Sun and its planets orbit a center of mass that is substantially displaced from the solar center by the mass of Jupiter. In fact, the center of mass is supposed to be barely within the solar mass. To be so specific, someone, surely, must have done some computation. One needs to find the actual papers to assess this.

The currently detectable redshift-blueshift cycles of some stars are attributed to planets with masses on the order of Jupiter's, and certainly not with masses like the Earth's (1/138 of Jupiter's mass).

The fact that the planet-hunter astronomers remove candidates from the list of finds, from time to time, indicates that they recognize phenomena that mimic the redshift-blueshift cycle that would be caused by a wobble. A case in point is the star HD 192263. Gregory Henry of Tennessee State University and others recently used photometric evidence to suggest that "rotational modulation of the visibility of stellar surface activity is the source of the observed radial velocity variations" of this star, which they said should therefore be removed from the list (*Astrophysical Journal*, Vol. 577, p. 111, 2002). ("Radial" means "line of sight.")

By the same token, the phenomena that have led to the removal of this or that star from the candidate list, have so far not been found to apply to all (or even many) candidates. This does not close the case, of course, because we don't know anything about the things that we don't know about.

It is to their credit that the planet hunters refer (most of the time) to "candidates" rather than certain finds. It is equally unfortunate that the *process of discovering the truth and the happiness*



it brings is sometimes short-circuited by categorical statements that “of course there are extrasolar planets,” as a NASA educational web site currently does.

The work of David F. Gray at the University of Western Ontario provides a good example of useful skepticism of the planet hunters’ methods. When Pegasi 51 was announced in 1995 as the first star that was all but proven to have one or more planets, reported in a Letter to *Nature* (Feb. 27, 1997), that the asymmetry of the spectral lines of Pegasi 51 undergoes a periodic change—and the period is 4.23 days, just the period attributed to the inferred planet. The presence of a planet is not expected to induce such a periodic change of line asymmetry, but the oscillation of the star’s surface would cause it.

Gray believed that the planet hunters, whose technique prevents them from seeing changes in the shapes of spectral lines, mistook a change of shape for a shift in the line as a whole. (See Gray’s book, *The Observation and Analysis of Stellar Photospheres*.) I reported on this in *The New Federalist* newspaper in March 1997.

The four astronomers principally involved in proclaiming the Pegasi 51 planet, instead of taking delight in the possibility that Gray could shed fresh light on the subject, reacted defensively—or rather, offensively—as if their property were being stolen. But Gray himself and a few other astronomers immediately launched new research to confirm or disprove his results. These new studies clearly failed to show the behavior Gray had found earlier. Gray concluded that his earlier observations had been too intermittent. His report may be found at <http://phobos.astro.uwo.ca/dfgray>.

In a recent communication to me, Gray pointed out the usefulness of his work on the subject: “We considered several alternatives and arguments regarding interpretation of radial-velocity variations that should have set the stage for more careful work in the spectroscopic detection of planets.” But, he adds, “I think most of the planet people pretty well ignored the important point we were making.” Nevertheless, Gray writes, “I rather doubt that a large fraction of the claimed planet detections will prove to be false.”

He may be right. It seems reasonable to suppose that the process by which the Sun’s planets were formed, was part of the larger process by which the Sun itself was formed. Would not other, similar stars be likely to have planets, then? You note that this is plausible.

What are we to think, then, when Geoff Marcy and Paul Butler inferred a planet candidate with a period of 3.5 days around HD 209458 from Doppler data, and passed the information to Greg Henry, who repeatedly measured a 1.58 percent decrease in the star’s brightness with the same periodicity, which one would expect from a large planet’s transit across the disk of the star? I had generally ignored transit data when standing alone, but here, the transit data are confirming the Doppler results. Some will call HD 209458 a planet, as I do; others will call it a very strong candidate.

Work currently under way, however, is intended settle the question for this and other candidates, as Marsha Freeman reported. Two space-based astronomical interferometers now under construction under NASA’s auspices, the Full-sky Astrometric Mapping Explorer (FAME) and the Space Interferometry Mission (SIM), to be launched in 2004 and 2006, respectively, are to have such fine resolution that they will be able to detect the lateral wobble of a star (on the “surface” of the sky) by using background stars as points of reference. The astronomers will have Marcy and Butler’s list of candidates to work from.

Also exciting is the plan, reported by Freeman, to actually image extrasolar planets, for which the nulling/summing interferometer is probably the best instrument. The idea is that the light from two mirrors can be brought together in such a way that the wavefronts from the star cancel out, while those from the planet reinforce each other. Roger Angel and Nick Woolf of the Steward Observatory—pioneers in this—carried out a proof-of-principle experiment at the old Multiple Mirror Telescope in 1997, causing a star to disappear, while the dust ring around it appeared clearly.

Once this technique is developed at the Large Binocular Telescope on Mount Graham, Arizona, it can be taken into space. In fact, plans for such interferom-

eters—DARWIN, OASES, and TPF—already exist. These instruments will have the added merit of being able to study the atmospheres of extrasolar planets spectroscopically. Will we find any planets enveloped in the gases we associate with life on Earth?

## Who Says Von Neumann Invented the Computer?

### To the Editor:

Ralf Schauerhammer, in his article on Von Neumann [“The Artificial Reputation of John von Neumann’s Intelligence,” Fall 2000, pp. 53-59] is wrong on a major point that casts doubt on the remainder of his writing and especially on his conclusions. I don’t know where he did his research but most Computer Scientists know very well that Konrad Zuse, Babbage, Mauchly, et al. created the computer.

Instead, Von Neumann is credited with the first understandable description of how the stored program computer works. His unpublished paper, written circa 1945, so clearly explained the process that everyone could understand and exploit the new technology. When we talk of the “Von Neumann machine,” we are talking about the machine he described, not a machine he created. This is so widely known in the field that it is surprising that you would publish such misinformation.



Mr. Schauerhammer could take a lesson from Von Neumann and write his essays more clearly with less reliance on elliptical information.

He is obviously not writing to an audience of computer programmers or computer scientists; his homework isn't sufficient to impress people who understand the field. Therefore, expecting the non-computer-literate audience to understand veiled references to game theory is specious. The information he provides is insufficient to make his point that it isn't applicable to real world problems.

Your essayist should cut out the invective denoting bovine scatology and get to the point, back up his point, and draw conclusions that convince, not that confuse.

As the physicist Richard Feynman said, a scientist outside his field can be as stupid as anyone. John Von Neumann did stray a bit from his specialty, but for the most part was a brilliant mathematician. Mr. Schauerhammer, however,

seems to have strayed quite a bit further than Von Neumann from what he knows. Perhaps a more clear, better researched paper, with better explanations could make his point, but this article disappointingly draws doubt in Mr. LaRouche's organization. It isn't encouraging to see so much bovine scatology in LaRouche material.

**Paul Lecoq**  
Spokane Falls, Wash.  
lecoqpaul@hotmail.com

## Ralf Schauerhammer Replies

In my article, I quoted *The Financial Times*, which declared John von Neumann to be "The Man of the Century" because he was the inventor of the computer. It would be interesting to see whether you will attack *The Financial Times* for this "major wrong."

As you probably remember, I state very explicitly my approach to the question. I quote from my article:

"[T]he objects we designated with certain words, change with the development of technology. That is why it is not enough to consider only the function of a technology if we want to judge how certain inventions have unfolded; it is also necessary to investigate how the economic realization of this function was possible, in specific cycles of work, at a specific time. We have to consider an 'evolutionary series' of this technology, and pay attention to the emergence of its different 'organs,' which make it what it is today, and which make it possible to develop in the direction it will take in the future. In this context, I present a short overview of the history of the development of the calculating machine."

And, indeed, if you allow yourself the pleasure of finding out the real conceptual history of the computer, you will discover that there is no place for the much celebrated von Neumann. Actually, what you state on the "major point" fully confirms this. You should ask yourself, why the "Von Neumann machine" is "the machine he described, not a machine he created." Why do you do that? Someone, who "describes" something that someone else created is by definition not a genius; he is at best a good teacher, but not an inventor.

In addition, you have to admit that

your statement that von Neumann made the "first *understandable* description of how the stored program computer works" (emphasis added) is a very subjective one. I, for example, understand this already very well in the writings of Mauchly and in those of Konrad Zuse from the end of the 1930s.

By the way, don't blame the "essayists" for "confusion"; it originates from belief in wrong authorities.

## Defining Moral Action

To the Editor:

Ralf Schauerhammer writes in "Why There Really Are No Limits to Growth," [Spring 2002, p. 60], "True human freedom is moral action," and "The creative man acts morally when he is acting in accordance with his free will."

I ask Mr. Schauerhammer to define "moral action."

My reason for having his definition is as follows: As a creative man and acting in accordance with my free will—am I acting morally if I steal money from a bank? I'll accept the dictionary definition of "steal."

I'm also not sure what Mr. Schauerhammer means by "true human freedom" and "creative man," as these terms apply in his statements. When Mr. Schauerhammer uses these terms, is he inviting the reader to question if there is a human freedom other than "true"? Or that he has a specific meaning for "creative" man?

**Edward T. Marshall**  
Los Alamitos, Calif.

## Ralf Schauerhammer Replies

Your letter refers to a passage of my article in which I try to explain the fundamental difference between the Hobbesian world view of liberal pleasures and the Leibnizian concept of human freedom. You cut a few words out, and play a bad trick by mincing words. Do you really not know if stealing money is morally good or bad?

Please do not try to follow Mr. Voltaire, whose ugly *Candide* did not succeed in defaming Leibniz's beautiful *Theodicy*, but read the whole passage again and try to understand what it means that "To be like God is the destiny of man."

**INFINITE ENERGY**  
**MAGAZINE**  
New Energy • New Science



Sample Copy of Current Issue  
\$5.95 North America/\$10.00 Foreign

Subscription (6 Issues)  
\$29.95 North America/\$49.95 Foreign

Contact us for our catalog of books, videos and other products, or visit our website.

**New Energy Foundation, Inc.**  
P.O. Box 2816-TF  
Concord, NH 03302-2816  
Phone: 603-228-4516 • Fax: 603-224-5975  
<http://www.infinite-energy.com>

## Colonel Roy Vinson, Inventor of MagneTrain, and Julia Vinson

General Douglas MacArthur's legendary reminiscence of the line from a barracks-room ballad "Old soldiers never die," could not be more true than in the case of Colonel Roy Douglas Vinson. No one who met him, friend or foe, will ever forget him.

Colonel Vinson died in the night of October 29, 2002, two weeks short of his 88th birthday. Ten hours later, Julia, his wife of 57 years, who had been hospitalized for some

time, followed him. Whoever had had the privilege of meeting this couple, as I did in August 2000, understood the special ties, of war and survival, which bound them so closely.

The daughter of a well-to-do Greek land-owning family, Julia barely escaped death—for the first time—when Nazi-occupying forces took reprisal on a wedding party in a village near to her own. Because her dress was not ready, Julia arrived late for the affair, only to discover that her whole family had been massacred. Later, she made an escape from a Nazi slave-labor train by swimming a river, but lost her cousin and fellow-prisoner to the currents.

She was later recaptured, and ended up in Germany near the end of the war. Her vivid description of running from a building with another girl, whose hair burst into flames in the midst of an Allied fire-bombing raid on the city, has never left me. That was about the time she met and soon married Major Roy Vinson, who was then the assistant to the military governor of occupied Frankfurt.

Like all serious military men I have met, Colonel Vinson spoke of war as



Laurence Hecht

*Colonel Vinson demonstrates the levitation system for MagneTrain to 21st Century associate Anna Shavin, as his wife, Julia, looks on.*

something to be avoided at all costs, never as a glorious affair. He was an ardent supporter of President Franklin D. Roosevelt in peace and war. Yet, he was a combat officer, a Major of Armor, who was known to the men of Patton's Army as "George, Jr." He did not work directly with Patton, but told me that he got the name, because he and General Patton "thought alike." Roy believed that the classical doctrine of war of annihilation was the surest and quickest way to bring a war to its end.

In 1946, as a member of Eisenhower's staff, Roy was put in charge of the rehabilitation of the entire German economy in the U.S. zone—all road, rail, and water transport, and all manufacturing industries.

When war broke out in Korea, Roy volunteered for service again. He was sent to Korea with the rank of Colonel, where he played a crucial role in training combat officers and troops of the South Korean Army as a Technical Member of the General Staff Inspection Team. Coming out of service the second time, Roy worked in the military shipbuilding and aerospace industry.

In 1962, he was selected as assistant

to the head of the start-up program for Project Apollo at Rockwell International. From 1963 to 1968, after promotion to Senior Project Staff Engineer, he served as the chairman for many engineering changes.

### MagneTrain

I visited Roy at his West Covina, California home in the summer of 2000, to interview him about the high-speed, magnetically levitated rail system, known as MagneTrain, which he had invented.

One day in 1972, he was driving down the Los Angeles freeway, with a friend, a design engineer specializing in large structures, when the thought of suspending a train by permanent magnets occurred to him. He decided to work at it, and one night the inspiration came to him. It was a hydraulically controlled system, mounted at the top of a suspended train car. The suspension magnets were attached by hydraulic lines to cylinders in which the varying weight of the car pressed down with pistons. (See *21st Century* website or the Winter 2000-2001 issue for details.)

With help of his engineering friend and a leading expert on magnetism, Roy developed this into a concept for a 600-mile-per-hour magnetically levitated rail system. In the early 1990s, a major U.S. aerospace firm decided to adopt his concept for a scale-model program, but backed away at the last minute. Roy envisioned a U.S.-led crash program to build magnetic levitation systems around the world, modelled on the Apollo project. I think Roy's dream will soon come true.

—Laurence Hecht



*"A playful composition, taken in the context in which it was used," ruled Judge Paulo Maurício Pereira of the MSIA's version of the WWF logo. The illustration was captioned "Prince Philip wants you to give him a hand."*

**WWF LOSES SUIT AGAINST LAROUCHE ASSOCIATES IN BRAZIL**

Brazilian Judge Paulo Maurício Pereira threw out a lawsuit in October, filed by the Brazilian chapter of the Worldwide Fund for Nature (WWF), which had complained, among other things, about the ironic depiction of the WWF's symbolic panda chewing on a human bone. The failed suit had been brought against the Ibero-American Solidarity Movement (MSIA), Brazilian cothinkers of American economist and statesman Lyndon H. LaRouche, Jr. The rejection of the lawsuit came just after the stunning electoral victory of Dr. Eneas Carneiro, an outspoken advocate of LaRouche's policies from the PRONA party, in his race for Congress from São Paulo. Carneiro's 1.5 million votes was the largest ever vote total for a Brazilian congressman.

Judge Pereira, who presides in Rio de Janeiro's 24th Civil Jurisdiction, ruled that the WWF suit was "without merit." Worldwide Fund for Nature, a non-governmental organization created by the British monarchy, had demanded 50,000 reais for "moral damages" allegedly caused by the MSIA's denunciations of the Fund's lying attacks on large infrastructure projects and economic development in general. Judge Pereira wrote that the MSIA's denunciations were coherent with the freedom of expression guaranteed by Brazil's constitution. Further, he said, the opinions expressed do not constitute "falsehoods or distortions, as they can be summarized as discussion involving what nationalists call 'the imperialist policy of the great world powers' and 'the policy of the internationalization of the Amazon,' material which for some time has been discussed by the media, including by members of the Brazilian government and military, seen as their duty to defend our borders and sovereignty."

**CANADIAN REACTOR TO PRODUCE MEDICAL ISOTOPES**

A restart of low-power commissioning of the Maple 1 reactor in Chalk River, near Ottawa, was authorized by the Canadian Nuclear Safety Commission in October, according to the plant operator, MDS Nordion. Maple 1 is one of a pair of reactors that, when fully operational, will "be capable of supplying more than 100 percent of the world's demand for key isotopes used in diagnostic and therapeutic medical applications," an MDS Nordion official said. Low-power commissioning of Maple 1 had been interrupted in July 2000, when problems arose during testing of the reactor's shut-off rods. Maple 1, and its twin reactor, Maple 2, when completed will be "the only ones in the world dedicated exclusively to the production of medical isotopes," according to MDS Nordion.

**ALEXANDRIA LIBRARY REBUILT, AFTER 1,600 YEARS**

The great library at Alexandria, burned in 48 B.C. during Julius Caesar's siege of the Egyptian city, and looted and destroyed under subsequent Roman emperors, has been rebuilt. In an Oct. 16 speech to 3,000 dignitaries, Egyptian President Hosni Mubarak dedicated the new building constructed on the original site, saying: "By building it back in place, we are reviving human heritage in the area. . . . The old one was a monolith of diligent scientific research and collective cultural efforts. It was an epitome of persistent efforts to combine and integrate all cultures and civilizations, and to unify the world as we all try to do now."

The destruction of the first library meant the loss of hundreds of thousands of volumes of ancient works, most of which will never be recovered. In 1974, Egyptian historian Mostafa al-Abadi came up with the idea to build a new library on the site. In 1990, \$230 million was pledged, mainly by Iraq, Saudi Arabia, and the United Arab Emirates. The Egyptian government underwrote the budget. The new library, called the Bibliotheca Alexandrina, now houses 4 million volumes. The design of the building is circular, to reflect the Sun, a central motif in Egyptian culture. On a granite wall encasing the building, all the alphabets of the world have been carved.



Government of Egypt

*The granite circling wall of the new Bibliotheca Alexandrina bears inscriptions in all known languages, ancient and modern.*

### WASHINGTON STATE GROUPS SUE DOE TO STOP FFTF SHUTDOWN

Benton County in Washington State, on behalf of local groups, has sued to stop the U.S. Department of Energy from shutting down the \$2 billion Fast Flux Test Facility (FFTF) at Hanford. The DOE's plan to drain the sodium coolant from the FFTF would permanently destroy the facility. The FFTF was originally built to test materials for fission and fusion reactors, and it operated successfully for 10 years, producing 60 different isotopes. The DOE has classified the FFTF as "surplus." Local entities, including the Port of Benton and the City of Richland want to restart it for commercial operation.

The suit charges that the DOE has failed to adequately analyze the impact on U.S. health care programs of the FFTF's successful production of medical isotopes for the treatment of cancer and other diseases. At present, the United States must import 90 percent of its medical isotopes. In addition, the FFTF is able to test fuels and materials for fourth generation nuclear reactors, to produce plutonium-238 for space power systems, and to test methods for transmutation of high-level nuclear waste.

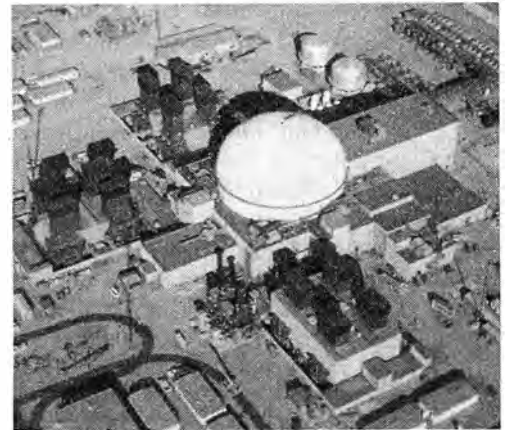

DOE

*The FFTF at Hanford: A unique nuclear facility fights to stay alive.*

### AFRICAN ANTI-MALARIA ORGANIZATION MAKES CASE FOR DDT

Malaria cases rose by 1,000 percent in South Africa in the late 1990s, after DDT was removed from the malaria control program, under "ferocious environmentalist pressure," wrote Richard Tren in a commentary published Nov. 11 by United Press International. Tren is director of the South African organization Africa Fighting Malaria. After DDT was reintroduced in 2000, he said, there was an 80 percent reduction in the number of cases in one year. Tren criticized the United Nations Environment Program for lobbying African countries to sign on to the Stockholm (POPs) Convention.

### NOW THEY'RE AFRAID OF CHILDREN. . . .

If you thought nuclear power and artificial sugar were the scariest things on Earth, you ain't seen nothin' yet. The real danger, according to the demons at the Washington-based Population Institute, is children in poor countries. These middle-aged misanthropes have even coined a new name for it: the "youth bulge." Says Population Institute President Werner Fornos: "Proliferating urbanization, combined with large concentrations of young people in the world's poorest regions, is setting the stage for a nightmarish cycle of political turbulence, revolutions, ethnic wars, and anti-government activities." So why not just feed them, and use the technology we've had for more than 50 years to industrialize and develop the countries they live in?

### LAROCHE CALLS FOR 'SUPER TVA' INFRASTRUCTURE PROJECT

Lyndon H. LaRouche, Jr., declared candidate for the 2004 Democratic presidential nomination, launched a major campaign drive in November, to force through an FDR-style "Super-TVA" of emergency infrastructure building. The program focusses on energy production and distribution, water management, and mass transit rail network programs, mostly on the state level, but with backing by the Federal government.

The candidate said that these immediate emergency measures are necessary, to halt the spiralling, accelerating collapse in state economies. He called for a new Federal credit-generating mechanism, even larger than the project-oriented TVA of Franklin Delano Roosevelt. The new mechanism should not pour funds into the repayment of old state debts, he said, but into major, urgently needed infrastructure projects, which will create the productive jobs and the expanded tax revenue base to solve the economic crisis. The existing state debts will have to be restructured. LaRouche proposed emergency legislation to disburse low-interest, long-term credits to the states, and a repeal of the deregulation laws of the past 30 years. LaRouche's "Emergency Infrastructure Program for the U.S.," an 80-page Special Report, is available from *Executive Intelligence Review* at [www.larouchepub.com](http://www.larouchepub.com).



EIRNS

*A map from LaRouche's Emergency Infrastructure Program, shows some of the lines that now exist (thin lines) and the projected high-speed rail lines to be built in major corridors (heavy lines).*

## Mosquito Spraying Essential To Keep America Healthy

**T**he introduction and spread of West Nile virus in the United States has reawakened an appreciation of mosquitoes as vectors of diseases. I use the term "reawakened" advisedly, for mosquito-borne diseases were once quite prevalent in the United States, and, indeed, played a major part in shaping our nation's destiny. Dengue fever, long a scourge in the tropics worldwide, was in fact first described by Dr. Benjamin Rush in Philadelphia in 1780. Yellow fever caused more than 100,000 deaths in 135 separate epidemics in the United States from 1793 until 1900. As late as 1934, there were 125,566 cases of malaria.

These diseases no longer claim victims in the United States as a matter of course, largely because of the exemplary efforts of organized mosquito control agencies, in conjunction with an enlightened and effective public health infrastructure.

As early as 1905, mosquito control pioneers recognized the value of a diversified approach, by integrating surveillance, source reduction, personal protection, and chemical and biological control. Early control methods consisted of ditching, draining, and/or filling marshes, applying oils to water to kill immature mosquitoes, and insecticide sprays against adults.

Soon, citizen groups began conducting referenda to establish special taxing districts to fund organized mosquito control activities. The first districts were established in New Jersey in 1912. California and Florida followed suit in 1915 and 1925, respectively. In the ensuing years, mosquito control personnel refined their methods through applied research, and assisted federal and state agencies in developing certifi-

---

**EDITOR'S NOTE:** Although this article does not discuss DDT, it refutes many of the fears and misconceptions about pesticide spraying in general, promoted by the pseudoenvironmentalists.



by Joseph M. Conlon

cation criteria to ensure conformance to stringent safety standards. The result: the most technically proficient, professional vector control agencies in the world.

### Stringent Regulations

This success did not come about in a regulatory vacuum. Since its inception, the Environmental Protection Agency (EPA) has regulated mosquito control through enforcement of standards instituted by the Federal Insecticide, Fungicide, and Rodenticide Act. This legislation mandated documentation of extensive testing for public health insecticides, according to EPA guidelines, prior to their registration and use. These data requirements are among the most stringent in the federal government and are met through research by established scientists in federal, state, and private institutions.

This process costs a registrant several million dollars per product, but ensures that the public health insecticides available for mosquito control do not represent health or environmental risks when used as directed. Indeed, the five or six adult mosquitocides currently available are the selected survivors of literally hundreds of products developed for these uses over the years. The dosages at which these products are legally dispensed are at least 100-fold less than the level at which public health and environmental safety merit consideration.

In fact, literature posted on the web-

sites of the EPA Office of Pesticide Programs, Centers for Disease Control and Prevention (CDC), American Association of Pesticide Safety Educators, and National Pesticide Telecommunications Network, emphasizes that proper use of mosquitocides by established mosquito control agencies does not put the general public or the environment at unreasonable risk from runoff, leaching, or drift when used according to label specifications. (For the federal government's position on risks associated with mosquito control insecticides, visit the website <http://www.epa.gov/pesticides>.)

Even with these safeguards, organized mosquito control agencies often go to extraordinary lengths to accommodate individuals who, for varying reasons, prefer that their property not be sprayed with approved public health insecticides. When surveys indicate the need for adult sprays, they are approved, planned, and conducted with special regard to the concerns of chemically sensitive persons. Personal notification of chemically sensitive individuals of spray times, in addition to using Global Positioning Systems (GPS)/Global Information Systems (GIS) technology to reduce the likelihood of drift over unauthorized areas, are but a few of the means utilized to ensure mosquito control serves the entire public spectrum.

The integrated mosquito management methods currently employed by organized control districts and endorsed by the Centers for Disease Control and EPA are comprehensive and specifically tailored to safely counter each stage of the mosquito life cycle. Larval control

---

*Joseph M. Conlon, a medical entomologist, is the Technical Advisor for the American Mosquito Control Association, based in Florida. He served as a U.S. Navy Medical Entomologist from 1981 to 2000, when he retired from the Navy with the rank of Commander. He is a member of several state mosquito control associations.*

through water management and source reduction, where compatible with other land management uses, is a prudent pest management alternative—as is use of the EPA-approved larvicides currently available.

When source elimination or larval control measures are clearly inadequate, or in the case of imminent disease, the EPA and CDC have emphasized, in a published joint statement, the need for application of adult mosquitoicides by certified applicators trained in the special handling characteristics of these products. The extremely small droplet aerosols utilized in adult mosquito control are designed to have an impact primarily on adult mosquitoes that are on the wing at the time of the application. Degradation of these small droplets is rapid, leaving little or no residue in the target area at ground level. For these reasons, the use of very low application rates for these products, generally less than 4 grams active ingredient per acre, are possible.

#### **Ensuring Safety**

Since 1980, well over 2,000 peer-reviewed scientific studies in various national and international refereed journals have documented the safety and efficacy of these public health insecticides at label rates.

Despite intense pressures from environmentalists to eliminate the use of public health insecticides, the Centers for Disease Control and Prevention, the World Health Organization, and other public health organizations all agree that it is essential that these products remain available for disease prevention. These agencies also agree that editorial or irresponsible misrepresentation of the risks involved must not lead to the greater risk of not having these insecticides available when truly needed. Such insecticides must remain available for the control of vectors in the times of even greater public health emergency that are sure to come.

The complexities involved in effectively and safely controlling the few dozen harmful species

among the 167 different mosquitoes found in the United States are often profoundly misunderstood and serve as fertile ground for the defiantly ignorant. A number of articles have recently been published through various media outlets that have taken the mosquito control profession to task for any number of real or imagined shortfalls regarding the use of public health insecticides.

I do not question the activists' commitment to a healthy environment for their families. But medical history has shown that the Nature that Mitchell Cohen quotes as saying, "O, get your filthy sprays off of me" is the same Nature whose malaria each year claims 1 of every 17 child deaths worldwide and has to date killed upwards of 150 people in the current U.S. West Nile virus outbreak. These deaths are documented, not surmised or extrapolated from suspect laboratory studies.

Our mission is to prevent or mitigate these diseases by whatever acceptable means we have available. Twenty years in the vector control profession have convinced me that killing adult mosquito populations should be an integral part of an effective, environmentally sensitive mosquito-borne disease control program—and both the U.S. Centers for Disease Control and Prevention and the World Health Organization agree.

#### **Mosquitoes Vs. Human Health**

I challenge dissenting activists to look at the website on encephalitis (<http://communities.msn.com/EncephalitisGlobal>) and observe the very real tragedy of mosquito-borne encephalitis

as related by survivors of these devastating diseases. Their pain is real—not "associated" or "extrapolated." To dismiss their distress as an acceptable price for the prohibition of legally registered pesticides is grossly irresponsible and inimical to humanity's most noble instincts.

There are certainly risks associated with operating spray equipment, be it through normal operations or the nefarious means of terrorists. However, these *hypothetical* risks are minuscule compared to the far more established risks such as mosquito-borne diseases. We cannot allow resources to be diverted to the hypothetical, while immediate hazards are left to take their human toll.

A particularly insidious ploy of the anti-pesticide lobby involves pressuring municipalities to spray only *after* human cases of disease have been identified. Although we should not conduct adult mosquitociding operations unless there is compelling reason to do so, the discovery of infected mosquito pools alone establishes an imminent danger of West Nile virus transmission to human beings, requiring corrective action. Furthermore, the 3 to 12 day incubation period in humans for West Nile virus indicates potential transmission occurring during this period, where mosquitoes are infective prior to appearance of human disease.

Allowing human disease transmission when we have the means to interrupt it is unacceptable to any entity charged with safeguarding the public's health.

#### **Save the Mosquitoes?**

A number of articles have quoted National Park Service employees as saying that mosquitoes serve a vital ecological function. This is not informed scientific opinion on the question. It is misleading to imply that mosquitoes occupy some irreplaceable, unassailable niche in the ecosystem. Although we should not gratuitously attempt to remove any species from its natural element, there is ample evidence that other species would fill the mosquito void.

*Continued on next page*

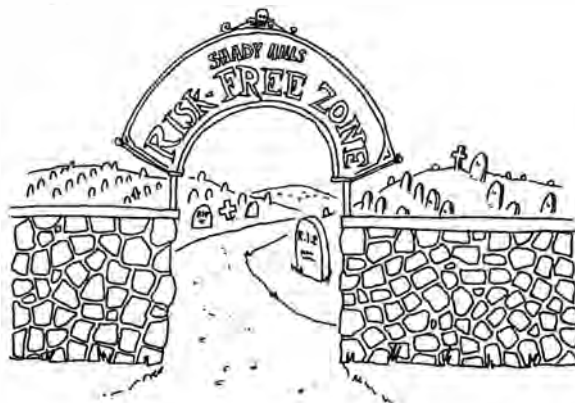

## Viewpoint

*Continued from previous page*

Furthermore, mosquitoes most assuredly do *not* serve as important food sources for birds and bats—as even a cursory review of the peer-reviewed scientific literature on the subject readily shows. In fact, the U.S. Fish and Wildlife Service, realizing that current institutional policy required review, has hired an entomologist to produce a handbook on mosquito control in wildlife refuges in order to bring some expertise to bear on the process.

All pesticides, whether natural or synthetic can be dangerous if used improperly, but any assertion that they are, by nature, a threat to public health misrepresents the true risk. The vast bulk of chemical pesticides to which human beings are exposed are *naturally occurring* in the fruits and vegetables they eat, and for these and every other chemical, some level is toxic.

The fact is, that there are more natural carcinogens by weight in a single cup of coffee than potentially carcinogenic synthetic pesticide residues in the average American diet in a year. This doesn't mean that coffee is dangerous, but rather that worst-case risk assessments do not represent the true risks involved. Indeed, Dr. Bruce Ames, developer of the most widely used carcinogenicity test available today, has estimated that Americans consume approximately 1.5 grams of *natural* pesticides per day—which is approximately 10,000 times more than they are exposed to by way of synthetic pesticides. [See Bruce Ames, "Environmental Pollution and the Causes of Human Cancer," *21st Century*, Sept.-Oct. 1989, p. 40.]

This is meant to place the exposure dynamic from the application of synthetic pesticides in its true perspective. The constellation of adverse effects reported from pesticides in activist documents represent exposures *several thousand orders of magnitude in excess* of those expected from even repeated applications at label rates. The *post hoc* fallacies that are often derived therewith from selective citations of scientific studies do nothing to further the health and general welfare of the public.

### Pernicious 'Precaution'

A singularly pernicious argument is often made by denigrating comparative risk assessments in favor of the "Precautionary Principle." The requirement for proof of absolute absence of importune effects from pesticides over the long term represents an unreachable standard. One could easily make the same case with regard to antibiotics that have demonstrably saved several millions of lives at the cost of a few hundred fatal anaphylactic reactions.

A "Precautionary Principle" writ large would effectively preclude the development and/or use of all chemical substances and products, whether they are produced by industrial means or discovered in our rain forests. To bolster their argument, activists often aver that pesticides are "never" applied as planned. Mistakes are surely made, but all human endeavors would be eliminated if subject to this zero-defects criterion.

Mosquito control professionals take great pride in ensuring that pesticides, when needed, are applied using technology that ensures effective targetting, dosage, and droplet spectrum—applied by individuals trained and certified in their use. GPS/GIS-monitored spray routes and spray output, droplet analysis, equipment calibration, comprehensive equipment maintenance schedules, and continuing education requirements are integral facets of any effective mosquito abatement program and are strongly endorsed by all members of the American Mosquito Control Association (AMCA).

Ground spraying can be difficult. However, a great deal of research has been conducted upon the production of a specified spray droplet spectrum, meteorological conditions conducive to optimal control, efficacy of treatments under a variety of conditions, and the fate of released droplets. Operations are timed to activity periods of the target to ensure maximum contact with the target and minimal impact upon non-targets. Ultra-low volume operations are not conducted when mosquito targets are resting or are otherwise unavailable.

Population dynamics of vector mosquito species are extraordinarily complex and are only now beginning to be understood. In this light, estimations of control efficacy are inexact at best.

Nonetheless, there is a large body of scientific literature demonstrating significantly reduced trap counts after adult mosquitocide applications. Given that the magnitude of questing mosquito populations constitutes a crucial variable in vector-borne disease transmission models, we should utilize all approved means to reduce these indices below the transmission threshold.

I agree with the Centers for Disease Control that applications of this type should not be the sole means of control in an urban setting. But that is not to argue that adult mosquitocides should not be used at all. Even a 30 percent kill rate would still have a significant impact on disease transmission.

### More Defiant Ignorance

The assertion that spraying may increase mosquito populations because of reductions in natural predator populations strains credulity and displays a profound ignorance of natural controls on mosquito populations. Furthermore, EPA's pesticide registration process is specifically geared to ensure that non-target effects are documented and minimized within a health and environmental cost-benefit context. Mosquitocides are thus required to be formulated and applied in such a way to maximize contact with the target and minimize drift off-target.

I know of no mosquito abatement district that possesses the excess resources that would allow them to use expensive pesticides indiscriminately, particularly with their attendant potential liability issues. In my experience, mosquito control professionals welcome the help natural predators give them and, indeed, have developed entire control programs, where feasible, to utilize natural control measures. Unfortunately, the equilibrium attained through natural predator/prey relationships is generally skewed toward a preponderance of the latter—and this may account for prey (mosquito) population levels far in excess of disease transmission levels. The "silver bullet" sought through the use of natural predators in the control of pests has been elusive, with some rather spectacular failures tempering the goal of their use as exclusive controls.

West Nile virus has now spread to 42 states in addition to the District of Columbia, and has accounted for almost



3,000 human cases and 150 fatalities. There is little doubt its emergence initially caught the public health community by surprise, underscoring the need for established mosquito control programs to meet unforeseen threats. Disease prevention through preparedness remains the mosquito control profession's primary focus, and is fully consistent with the very finest traditions of public health. Yet, the continued increase in worldwide tourism and trade virtually guarantees further challenges from exotic diseases

requiring ready control expertise to prevent their establishment and spread.

Should these emerging mosquito-borne diseases of man and animals settle into the American public health landscape, particularly as an unintended consequence of environmental policy initiatives, we will have only ourselves to blame, for we have the means to control these diseases within our grasp. We must remain prepared to accept and meet these challenges—our citizens and our nation's wildlife deserve no less.

U.S. Postal Service  
**STATEMENT OF OWNERSHIP AND CIRCULATION**  
 Required by 39 U.S.C. 3685

1. *Publication Title:* 21st Century Science & Technology
2. *Publication No.:* 0895-6820
3. *Date of Filing:* October 1, 2002
4. *Issue Frequency:* 4 times a year.
5. *No. of Issues Published Annually:* 4
6. *Annual Subscription Price:* \$16.67
7. *Complete Mailing Address of Known Office of Publication (Not printer) (Street, city, county, state and ZIP+4):* 21st Century Science Associates, 60 Sycolin Road, Leesburg, VA 20175. *Contact person:* Marsha Freeman *Telephone:* 703-777-7473
8. *Complete Mailing Address of Headquarters or General Business Office of Publisher (Not Printer):* 21st Century Science Associates, P.O. Box 16285, Washington, D.C. 20041
9. *Full Names and Complete Mailing Addresses of Publisher, Editor, and Managing Editor:* *Publisher (Name and complete mailing address):* 21st Century Science Associates, P.O. Box 16285, Washington, D.C. 20041 *Editor (Name and complete mailing address):* Laurence Hecht, P.O. Box 16285, Washington, D.C. 20041 *Managing Editor (Name and complete mailing address):* Marjorie Mazel Hecht, P.O. Box 16285, Washington, D.C. 20041
10. *Owner (Do Not Leave Blank. If the publication is owned by a corporation, give the name and address of the corporation immediately followed by the names and addresses of all stockholders owning or holding 1 percent or more of the total amount of stock. If not owned by a corporation, give the names and addresses of the individual owners. If owned by a partnership or other unincorporated firm, give its name and address, as well as those of each individual owner. If the publication is published by a nonprofit organization, give its name and address.):* 21st Century Science Associates, P.O. Box 16285, Washington, D.C. 20041.
11. *Known Bondholders, Mortgagees, and Other Security Holders Owning or Holding 1 Percent or More of Total Amount of Bonds, Mortgages or Other Securities:* None.
12. *Tax Status (For Completion by nonprofit organizations authorized to mail at nonprofit rates):* Has Not Changed During Preceding 12 Months.
13. *Publication Title:* 21st Century Science & Technology
14. *Issue Date for Circulation Data Below:* 6/1/01

15. Extent and Nature of Circulation	Average No. Copies Each Issue During Preceding 12 Months	No. Copies of Single Issue Published Nearest to Filing
A. Total No. Copies (Net Press Run)	20,513	19,000
B. Paid and/or Requested Circulation		
1. Paid/Requested Outside-County Mail Subscription Stated on Form 3541, (Include advertiser's proof and exchange copies)	3,075	2,693
2. Paid In-County Subscriptions	—	—
3. Sales Through Dealers and Carriers, Street Vendors, Counter Sales, and Other Non-USPS Paid Distribution	13,177	12,791
4. Other Classes Mailed Through the USPS	15	41
C. Total Paid and/or Requested Circulation (Sum of 15b(1), (2), (3), and (4))	16,267	15,525
D. Free Distribution by Mail (Samples, complimentary, and other free)		
1. Outside-County as Stated on Form 3541		
2. In-County as Stated on Form 3541		
3. Other Classes Mailed Through the USPS	147	20
E. Free Distribution Outside the Mail (Carriers or other means)	380	28
F. Total Free Distribution (Sum of 15d and 15e)	527	48
G. Total Distribution (Sum of 15c and 15f)	16,794	15,573
H. Copies not Distributed	3,719	3,427
I. Total (Sum of 15g and h)	20,513	19,000
J. Percent Paid and/or Requested Circulation	96.9%	99.7%

16. This Statement of Ownership will be printed in the Fall 2002 issue of this publication.
17. *Signature and Title of Editor, Publisher, Business Manager, or Owner:* MARJORIE MAZEL HECHT, Managing Editor, Oct. 1, 2002. I certify that all information furnished on this form is true and complete. I understand that anyone who furnishes false or misleading information on this form or who omits material or information requested on the form may be subject to criminal sanctions (including fines and imprisonment) and/or civil sanctions (including civil penalties).

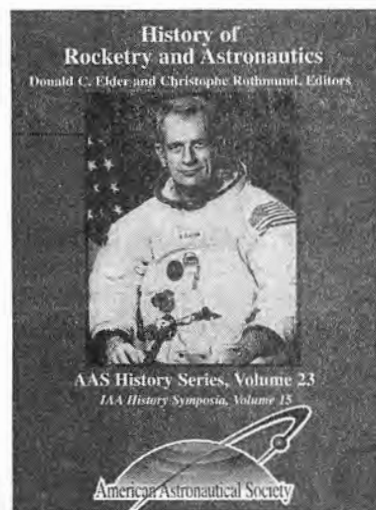

**HISTORY OF ROCKETRY  
 AND ASTRONAUTICS  
 BOOK SERIES**

**AMERICAN ASTRONAUTICAL  
 SOCIETY HISTORY SERIES**

For a complete listing of these excellent volumes on the history of rocketry and astronautics, including brief descriptions of each volume, tables of contents of most of the volumes and ordering information, please visit the following pages in the book sections of our Web Site:

- [http://www.univelt.com/Aasweb.html#AAS\\_HISTORY\\_SERIES](http://www.univelt.com/Aasweb.html#AAS_HISTORY_SERIES)
- [http://www.univelt.com/Aasweb.html#IAA\\_PROCEEDINGS\\_HISTORY\\_ASTRONAUTICS\\_SYMPOSIA](http://www.univelt.com/Aasweb.html#IAA_PROCEEDINGS_HISTORY_ASTRONAUTICS_SYMPOSIA)
- <http://www.univelt.com/htmlHS/noniaahs.htm>

**BOOKS ON MARS**

These volumes provide a blueprint for manned missions to Mars and a continued presence on the planet's surface, including what technology is required, and what kinds of precursor missions and experiments are required. For more information on the Mars books available, please visit the following page in the book section of our Web Site:

- <http://univelt.staigerland.com/marspubs.html>

If you would like for us to send you more information, then please contact us as follows:

**Univelt, Inc., P.O. Box 28130,  
 San Diego, CA 92198, USA  
 Tel.: (760) 746-4005;  
 Fax.: (760) 746-3139  
 E-mail:  
 76121.1532@compuserve.com  
 Web Site:  
 www.univelt.com**

# Mosquitoes, DDT, and

by J. Gordon Edwards, Ph.D.

*A leading entomologist describes the death and suffering caused by insect-borne diseases, and tells why we must bring back DDT.*

**D**uring the war in Europe, in 1944, we went to sleep every night while being fed upon by bedbugs and fleas, and there was no way to escape them. We had heard about "cooties" (body lice) causing typhus, which killed more than 3 million people in Europe and vicinity during and after World War I.

One day, I was ordered to dust every soldier in our company with an insecticidal powder that had just been received. For two weeks I dusted the insecticide on soldiers and civilians, breathing the fog of white dust for several hours each day. The body lice were killed, and the DDT persisted long enough to kill young lice when they emerged from the eggs.

Fortunately, no human beings have ever been harmed by DDT. I later learned that the material was produced by a German chemist, Othmar Zeidler, in 1874. He had made hundreds of chemical compounds but he never suggested uses for any of them. Sixty years later, in Switzerland in 1939, Dr. Paul Müller was seeking chemicals that might kill insect pests, and he followed Zeidler's written directions for preparing several compounds. One of them was a compound that Zeidler had labelled dichlorodiphenyl-trichloroethane. Müller called it "DDT," and in 1948, he received the Nobel Prize for his work with that chemical.

Dr. Joseph Jacobs later described his role in producing the first DDT made in the United States. At Merck & Company in New Jersey, he was assigned the task of duplicating Zeidler's procedure, but on a much larger scale. He commandeered a huge glass-lined reactor, and produced the first 500 pounds of DDT made in the United States. An Army truck rushed it to an airport, and it was flown to Italy, where it halted a developing epidemic of typhus in our troops. The Surgeon General telegraphed thanks from President Roosevelt, and stating: "It is estimated that 5,000 lives were probably saved by destroying the typhus-carrying body lice infesting our soldiers."<sup>1</sup>

After the war, I entered Ohio State University to study entomology. Insects are the most abundant forms of life on Earth;

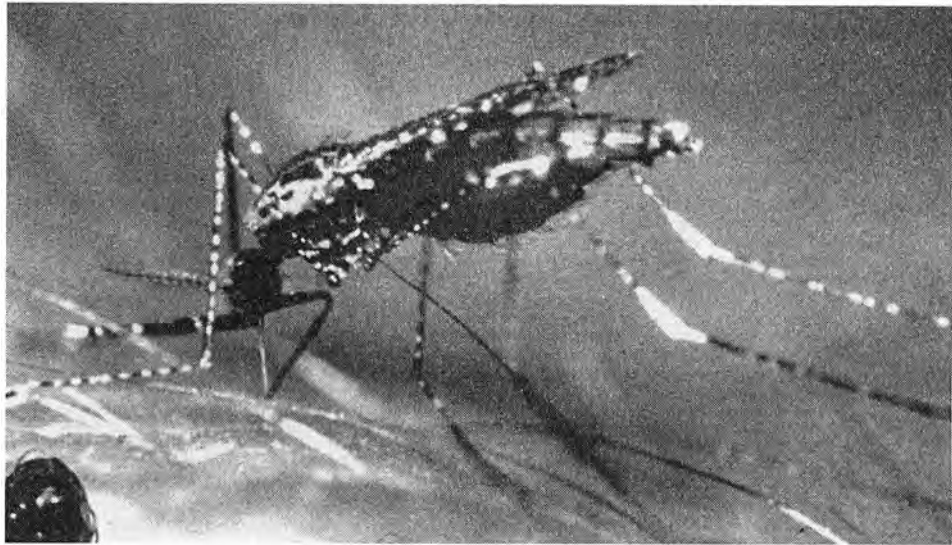

Pan American Health Organization/World Health Organization

*Anopheles, the mosquito that carries malaria, which today kills 2 to 3 million people a year.*

fortunately, only about 1 percent of them compete with human beings for food, fiber, and space. A small part of that 1 percent threatens our health with stings or bites, and a few transmit serious diseases.

I received my Ph.D. for research on beetles, and was hired to teach entomology at San Jose State University in California. There I spent much time studying parasitic insects, and taught medical entomology courses for more than 30 years. In addition to louse-borne typhus, our students were required to learn about diseases caused by mites, ticks, fleas, kissing bugs, black flies, chiggers, sand flies, eye gnats, tsetse flies, and mosquitoes.

## Insect-borne Killer Diseases

At least 80 percent of human infectious diseases are arthropod-borne—transmitted by insects, mites, or ticks.<sup>2</sup> They have caused the death of hundreds of millions of people by infecting them with the pathogens that cause typhus, bubonic plague, yellow fever, malaria, dengue fever, sleeping sickness, encephalitis, elephantiasis, leishmaniasis, and yaws.

# Human Health



Courtesy of Gordon Edwards

*DDT has saved more millions of lives than any other man-made chemical.*



U.S. Department of Agriculture

## Flea-borne Diseases

*Typhus*. In Europe there have been more than 150 typhus epidemics. During the Thirty Years' War, typhus reduced the population from 30 million to just 13 million, killing 14 times more people than died in battle.

Scientists named the pathogen that causes typhus *Rickettsia prowazeki*, after two researchers who lost their lives because of their work: While studying a Mexican typhus epidemic, Howard Ricketts died of typhus three weeks after becoming ill, and Stanislas von Prowazek died of typhus in Poland.

The *Saturday Evening Post*, in an August 1942 article titled "Blitz Plague," referred to the body louse as "the mass killer

*In World War II, troops and refugees were dusted with DDT powder to kill the lice that carried typhus.*

which has slaughtered 200 million people in Europe and Asia alone, diverted the stream of history, and done more than any other single factor to determine the outcome of wars." It reported:

This year, in the Polish town of Vilna, where typhus once killed 20,000 of Napoleon's troops retreating from Russia, railway employees were forbidden to approach trainloads of infected German soldiers returning from the

Russian front. When infected, a person's fever often reaches 107 degrees, with excruciating headaches and delirium. Mortality rates may be as high as 70 percent.

American troops had an edge on the Axis, for they had a promising new anti-typhus vaccine that was developed by Herald Cox at the Rocky Mountain Spotted Fever Laboratory in Hamilton, Montana in 1939. Previously, in typhus research labs, almost every medical laboratory worker was stricken and more than a third of them died of the disease.

**Bubonic plague.** In the 14th Century, fleas that sucked blood from sick rats ingested pathogenic bacteria that were later named *Pasteurella pestis*. When those fleas then bit humans, they transmitted bubonic plague to them. That plague (the "Black Death") killed one-fourth of the population of Europe and two-thirds of the population of the British Isles.

### Mosquito-borne Diseases

Mosquitoes have been the worst of all the disease carriers!

More than 3,000 species of mosquitoes have been described in scientific journals. Most of them are in tropical areas, where as many as 150 species have been found in a single square mile. The United States contains about 170 species, Canada 70, and Arctic lands less than two dozen. In the Canadian Arctic, researchers who bared their arms, legs, and torsos in an experiment reported as many as 9,000 bites per minute. Unprotected human beings there could lose half of their blood in two hours, and die. Hundreds of cattle and horses have been killed by just such exsanguination, in our southeastern states.

**Yellow Fever** is caused by a virus transmitted by *Aedes aegypti* mosquitoes. Perhaps the disease was brought into America with slaves in the 1500s, but it also could have originated in monkeys in Central America, which still harbor it.

The name of this disease refers to the yellowing of skin that results after the infected mosquito bites. After a 10-day gestation period, there is a sudden onset of fever, with aching, nausea, bleeding from digestive tract, lungs, nose, and mouth, and severe vomiting (frequently bloody). Mortality rates from yellow fever often exceed 50 percent of the cases.

In 1542, Hernando DeSoto suffered with it and almost half of his troops died of it, in what is now the state of Florida. In 1741, England sent Admiral Edward Vernon with 27,000 men to Mexico and the Louisiana Territory. They retreated after 20,000 were killed by yellow fever. In 1802, Napoleon's brother-in-law, Charles LeClerc, came to the Louisiana Territory with 33,000 soldiers, but gave up after 29,000 of them died of yellow fever.

*A dengue victim in a Venezuela hospital. Inset is the Aedes aegypti mosquito, carrier of dengue and yellow fever.*



Pan American Health Organization/World Health Organization

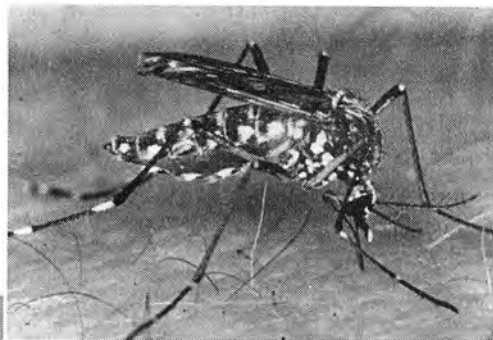

Napoleon had envisioned a French colonial empire in the New World, but after such severe losses he did an about-face and sold the Louisiana Territory to the American colonists for \$15 million, nearly doubling the size of our country. Some historians say that the sale was a result of yellow fever killing 40,000 French troops.

In 1900, in Cuba, the U.S. Yellow Fever Commission investigated the disease, under the guidance of Walter Reed, James Carroll, Jesse Lazear, and A. Agramonte. Their research with human volunteers proved that the fever was transmitted only by the bites of *Aedes aegypti* mosquitoes, rather than by personal contact.<sup>3</sup> Attempts to eradicate those mosquitoes almost succeeded in Central America and the Caribbean, but failed in southeastern United States, where *Aedes aegypti* still abound. Their larvae thrive in junk yards and auto wrecking yards, where they live in used tires and other small containers of water.

Yellow fever vaccines have been available since 1942, but must be kept refrigerated. That is a problem in hot countries, especially because Freon was unwisely banned by pseudo-environmentalists in the great ozone hoax. More than 400 million people have been given the vaccine.

In Central America a pretty native mosquito, *Haemagogus spegazzinii*, transmits the virus from monkey to monkey in the tree tops. If a tree falls in the jungle and human beings are nearby, the *Haemagogus* can transmit the virus to them. These individuals may then serve as reservoirs of the fever in their villages.

**Encephalitis Viruses.** Mosquitoes transmit many other kinds of viruses, causing illnesses such as Eastern Equine

Encephalitis (EEE), Western Equine Encephalitis (WEE), St. Louis Encephalitis (SLE), Japanese B Encephalitis (JBE), Venezuelan Equine Encephalitis (VEE), and West Nile Encephalitis. An epidemic of SLE in 1933 devastated St. Louis and several other cities as far east as Louisville, Ky. More than 1,000 cases there resulted in 266 deaths.

Japanese B Encephalitis has been very deadly in Japan and Korea. In 1924, Tokyo had 6,000 cases, and 3,800 died. In 1948, Japan had 8,000 cases and 4,750 died. The vector, the Asian Tiger mosquito (*Aedes albopictus*), is now well established in the United States, and has already transmitted fever viruses to children in southeastern and midwestern states, and in Texas. Transovarial transmission may pass encephalitis viruses from female mosquitoes to their larvae, via infected eggs.

*Dengue Fever* is also known as "Breakbone Fever" because the virus causes extreme aching of joints, even the joints between plates in the skull. Many kinds of mosquitoes transmit the virus, but *Aedes aegypti* is the major vector. In Guam, 98 percent of the American troops were infected. Some of my students served with the U.S. Navy and had been infected with dengue. They told me that the pain was "indescribable," and one said: "When I had malaria I was afraid I might die, but when I had dengue I almost wished that I *could* die." The only medication they had was aspirin, which gave very little relief.

In addition to the fever and other symptoms, the dengue virus causes great pain in the eyes, "like someone has his fingers behind your eyeball and is trying to pull it out." A first exposure to dengue is not often fatal, but re-exposures are more serious, with about 15 percent mortality caused, especially in children

The Asian Tiger Mosquitoes, *Aedes albopictus*, are efficient carriers of the dengue virus. When they first invaded Brazil, there were only 6 dengue cases in Rio de Janeiro (in 1985). In just one year, the mosquitoes spread the fever to 350,000 people! In 1985, some of these mosquito larvae were shipped into Houston Texas from Japan, in old automobile tires—they can breed successfully in as little as a quarter inch of water. In Evansville, Indiana, they were also breeding in piles of old tires. The piles were sprayed with insecticides every day, for 11 days, but swarms of adult mosquitoes still emerged. In early July 2001, Tiger Mosquitoes were found in the San Francisco Bay area of California. They had just arrived from China, in a shipment of live bamboo plants. The larvae had matured in the water surrounding the plant roots. This mosquito will probably extend its range from coast to coast, and many encephalitis cases should be anticipated.

## Malaria: 'Queen of Diseases'

Sir Ronald Ross, a British Army Surgeon in India, proved that the malaria protozoans could complete their development only in *Anopheles* mosquitoes, and that those parasites were in the saliva of the mosquitoes. Ross received the Nobel Prize in 1902 for his research on malaria.

There are more than 300 species of *Anopheles* in the world, but only 60 are closely associated with human beings; others feed on snakes, lizards, rodents, and birds. Avian malaria is a major cause of bird deaths. When marshes were sprayed with DDT to kill the mosquitoes that bothered people, bird popula-

tions in the marsh frequently increased very rapidly, because the adults and the nestlings were no longer getting malaria.

Human beings have suffered from malaria for centuries.

In Babylon, on June 28, 323 B.C., Alexander the Great died of malaria. He was 33 years old and had already conquered Egypt, Syria, Persia, Arabia, and Northern India. Alaric, King of the Goths, conquered Rome in 430 A.D., but then died of malaria. That Old World disease was brought to this Hemisphere many times, perhaps first by Columbus's sailors.

During the construction of the Panama Canal, William Gorgas used massive amounts of oil and other poisons to eradicate the mosquitoes from 100 square miles of jungle. Malaria was reduced there from an infection incidence of 800 out of every 1,000 workers in 1906, to only 16 per 1,000 workers, by 1916.

The California Mosquito Abatement Program was established in 1911, to control a malaria epidemic near the Sacramento River delta that had wiped out half of the residents. In 1914, the United States had 600,000 cases of malaria, most of which were in California and Florida.

According to the *WHO Newsletter*, several thousand malaria cases developed in 1919 near Archangel, Russia (64 degrees North Latitude); and in 1923, Russia had 5 million cases of malaria, with more than 60,000 deaths.

In the United States, in the 1930s, there were still more than 6,000 malaria victims every year. People at greatest risk protected themselves by swallowing bitter quinine pills three times a day. That method of protection was also used by British workers in malarious countries, and they discovered that drinking gin and tonic to wash the pill down made the quinine less repulsive.

An epidemic in Brazil, in 1938, was spread by imported *Anopheles gambiae*. There were more than 100,000 malaria cases, and 14,000 of the victims died within six months.

Today, more than 2 billion people—40 percent of the Earth's population—live in malarious countries. About 300 million of them are infected with malaria, and there are nearly 300,000 new cases every day. More than 30 percent of childhood deaths in Africa are directly caused by malaria.

### The Benefits of DDT

When a DDT malaria control operation is under way, the inhabitants are simultaneously protected from other insect-transmitted diseases, including plague, typhus, yellow fever, dengue fever, hemorrhagic fever, leishmaniasis, elephantiasis, river blindness, and sleeping sickness.

Because environmental extremists raised unwarranted fears about DDT, the United States banned DDT in 1972, and the spray programs in developing countries were reduced. This led to a resurgence of malaria that is still continuing. There are now more than 300 million cases of malaria, and the number in South Africa has risen by over 1,000 percent in the past five years.

Malnourished and feverish malaria victims simply cannot perform the necessary labor in the fields. Before the 1940s, India produced less than 25 million tons of wheat per year, and starvation was widespread. Protein deficiencies also caused conditions such as marasmus and kwashiorkor. After the use of DDT reduced malaria rates, India's farmers pro-



Colvey/USAID

The U.S. Agency for International Development reports that bednets treated with insecticide could reduce by 20 percent all childhood deaths in Africa. Now, of the yearly malaria-related deaths in Africa, about 2.25 million are children.

duced more than 100 million tons of wheat annually, and the nation's health was vastly improved.

Prior to its National Malaria Campaign, India had more than a million cases of malaria annually. The DDT anti-malaria campaign resulted in the number of deaths dropping from 750,000 annually to just 1,500 deaths per year. Also, the average longevity of 32 years increased to 45 years during this period.

During World War II, the South Pacific was a great center of malaria. On Guadalcanal, the annual malaria rate among our troops was 1,800 cases per 1,000 men; in other words, most of the men had malaria *twice* during that year. After DDT became available, the malaria rate there fell to about 40 cases per 1,000 men.

The Mediterranean island of Sardinia suffered 40,000 to 70,000 cases of malaria per year in the early 1940s. After DDT was applied, the infestation dropped to just 44 cases, in 1950.

In Ceylon (Sri Lanka), in the 1950s, there were 3 million malaria cases a year, with more than 12,000 deaths. DDT reduced the number of cases to only 31 in 1962, and a total of 17 in 1963 (with no deaths). Unfortunately, DDT use was stopped there and malaria rates soared to 1,700 in January 1968, 42,000 in February 1968, and nearly 2 million cases in 1969.

In June 1996, the World Health Organization reported that in Africa, before DDT, 1.5 to 2.7 million people died from malaria every year. Malaria still kills half of all children there before they are five years old. Bed nets cost \$5.00 each, and it costs 50 cents a year to treat a net with permethrin (a synthet-

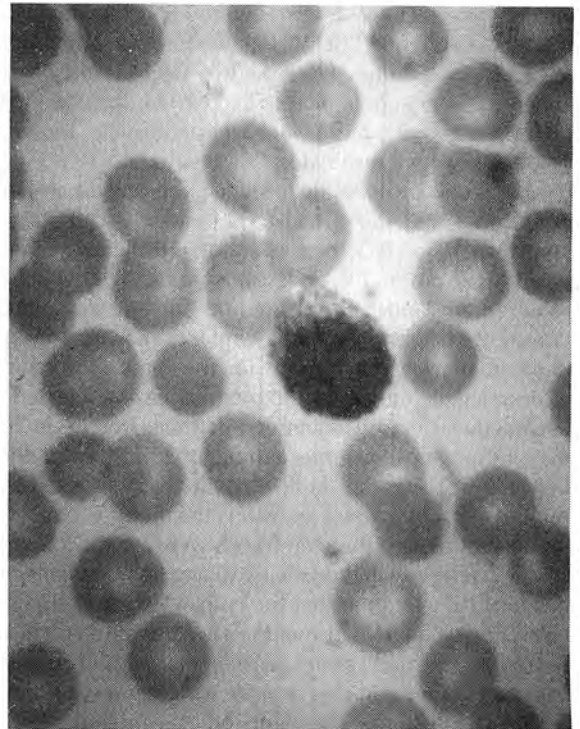

Centers for Disease Control

*Plasmodium* is a genus of protozoans, which includes four species that cause malaria in human beings. Here is the most common, *plasmodium vivax*, shown in the microgametocyte phase, in a thin blood film.

ic pyrethroid insecticide). Nets that are thus treated will repel or kill all mosquitoes for at least a month. Those nets are saving the lives of 500,000 African children from malaria, every year. But, as U.S. Navy Commander Kevin Baird reports, in malarious regions, "Even if a person sleeps in a screened room under a bednet, he or she will still receive roughly one infectious bite a week" and "There are parts of Africa where persons will get infectious bites every day."

Spraying with DDT to kill mosquitoes would save more lives, and be more cost-effective.

### How Malaria Develops

Four species of *Plasmodium*, a parasitic protozoan, can cause malaria in humans. They are *P. vivax*, *P. falciparum*, *P. ovale*, and *P. malariae*. The members of those species differ morphologically, behaviorally, and physiologically. Their plasmodia pass through three major developmental stages: sporozoites, merozoites, and gametocytes. The blood of a person suffering with malaria contains all of those stages. When a female *Anopheles* sucks up that blood, all of those stages enter the mosquito stomach. (*Anopheles* males do not eat vertebrate blood.) The gametocytes mature in the mosquito stomach and engage in sexual reproduction there. The resulting zygote penetrates the stomach wall and becomes an oocyst attached to the outside of the stomach, bathed in the blood of the mosquito hemocoel.

More divisions occur in the oocyst, releasing hundreds of young plasmodia (called sporozoites) into the mosquito blood.

A large number of them enter the mosquito salivary glands, and when the mosquito feeds, thousands of sporozoites are injected with the saliva. They travel very quickly to the human liver, where they multiply asexually for 6 to 12 days, producing hundreds of thousands of merozoites which then enter the bloodstream. Each one can invade an erythrocyte (the oxygen-carrying cells of the blood) and reproduce asexually there, producing 6 to 26 new erythrocytes. In tertian malaria, that reproduction takes only 48 hours, but in quartan malaria it takes 72 hours. At the end of that time, the new generation of merozoites bursts out of all the invaded erythrocytes and quickly burrows into new ones. After another 48 or 72 hours they synchronically burst out of the blood cells and repeat the process.

When merozoite numbers exceed 50 per cubic milliliter of blood (more than 150 million merozoites in a 140 pound person) the victim suffers a chill because of the shortage of functional red blood cells. As the erythrocytes are ruptured, toxins are released, resulting in fevers of 96 to 104 degrees. Frequently, victims also suffer with hallucinations and extreme anxiety. The human spleen removes sporozoites and merozoites from the blood, and becomes enlarged as a result. The swollen spleen is one symptom relied on to diagnose malaria. Kidney failure may also result in "blackwater fever," so-called because dead blood cells in the urine causes it to become a dark mahogany color. Cerebral malaria occurs if abundant parasites plug capillaries in the brain, and death may then result very quickly.

Falciparum malaria accounts for more than 90 percent of all malaria fatalities. Thirteen percent of its total genetic material is in variable genes that can switch on and off, fooling the immune response. The mortality rate of untreated falciparum malaria is 30 to 40 percent (about the same as for bubonic plague).

In quartan malaria, caused by *Plasmodium malariae*, the life cycle takes 72 hours, so the attacks of chills and fever occur every fourth day. The life cycle of the other three species of *Plasmodium* takes only 48 hours, so the chills and fever recur every third day, and thus the disease is called tertian malaria. *Plasmodium vivax* and *P. ovale* cause a relatively mild benign tertian malaria, but *Plasmodium falciparum* causes potentially deadly malignant tertian malaria. If the victim has paroxysms more often than every 48 hours, it indicates that multiple infections have occurred, and the ailment is called quotidian malaria.

### **Malaria Plasmodia Are Self-Protected**

The malarial parasite has 14 chromosomes and perhaps 7,000 genes. Researchers have predicted that "within 5 or 10 years they will have a vaccine that will actually save lives." (They have been predicting that for 25 years, but no effective vaccines are yet available! See box, p. 28.) Difficulties include the plasmodia being able to avoid human antibodies in the blood, and the plasmodia

not staying long enough in the human liver to be attacked by cytotoxic T cells there. When the merozoites are inside the human erythrocytes, they are safe from the immune system, and they multiply so furiously that, according to researchers, "even if an immune response kills 99 percent of them, there are likely to be enough parasites left to multiply and cause disease to continue to develop."

The primary antibody target on the sporozoites is a protein in the parasite's surface, but sporozoites are proficient at evading the immune system of human blood systems. When an infected mosquito bites, thousands of sporozoites enter the human blood, and in less than 10 minutes, they enter the liver, before the antibody response can be effective. There the sporozoites are safe from the antibodies, because in the liver it takes 10 or 12 days for killer T cells to develop, and the parasites do not stay in the liver that long. Each sporozoite in the liver forms a reproductive stage that produces about 30,000 merozoites, which quickly enter erythrocytes, where they are thus safe from both the antibodies and the T cells.

Each developmental stage (sporozoites, gametocytes, and merozoites) may mutate independently and frequently, so within each population there develop slightly different "strains" whose members may differ significantly.

Immunity to vivax malaria sometimes develops naturally. Fetal hemoglobin is evidently not favored by mosquitoes, so babies may have a degree of resistance to malaria. It takes about five years for adult humans to develop partial immunity to vivax plasmodia,<sup>4</sup> and if the person moves to another location, the immunity may be lost because of local differences in the plasmodia.

A different kind of immunity to malaria occurs in people who suffer from sickle-cell anemia. They have erythrocytes that are hard and somewhat curved, and are not good hosts for the malaria plasmodia. Children who inherit the gene for sickle cell from both parents usually die early, of anemia. If they



Pan American Health Organization/World Health Organization

*A doctor tends a malaria victim in Sudan.*



P. Viro/WHO

Entomologists have to know where to find the larvae of different mosquito species, which each have specific habitats. *Aedes* deposit their eggs in the sand or mud by the water's edge. Here, mosquito grubs near a pond in Ethiopia.

inherit the sickle cell trait from only one parent they are likely to live, and they will not suffer as much from malaria because the plasmodia do not prosper in sickled cells. A "balance" therefore exists between homozygous sickle cell victims (who may die of anemia), homozygous non-sickle-cell victims (who may die of malaria), and heterozygous individuals who may suffer slightly from both the anemia and the malaria but are not killed by either.

### Mosquitoes Are Not All Alike

Mosquitoes develop through four larval stages, followed by the pupal stage. The time from egg to adult may be as short as 4 days, but usually is a week or two, depending on temperature and food.

Adult female *Anopheles* have palpi (oral appendages) about as long as their proboscis, while all other female mosquitoes in the United States have very short palpi. In both sexes of *Anopheles*, the top of the abdomen bears slender hairs instead of the flat scales that occur on the abdomen of our other mosquitoes.

Adults of genera *Culex* and *Culiseta* have the abdominal apex blunt, or rounded, but in the genus *Aedes* adults have the tip of the abdomen slender and pointed.

The larvae (wigglers) of most mosquitoes have a slender breathing tube at the end of the abdomen, and the body hangs downward from the breathing tube (the tip of which is at the water surface). *Anopheles* larvae have no such breathing tube, and their body floats parallel below the water surface. *Anopheles* eggs have a buoyant "float" on each side, and they float individually on the water surface. *Culex* and *Culiseta* eggs are deposited in "rafts" that float atop the water, while *Aedes* eggs are deposited individually in the sand or mud by the water's edge.

The behavior and habitat preferred by members of the different species are very specific. Some larvae live only in fresh water, others only in stagnant water, brackish water, or saline

water. Some prefer sunny water, others live only in shaded areas. A few kinds live only in the water in "tree-holes."

Blood meals are usually required before parasitic female insects can produce offspring; however some species of mosquitoes are "autogenous" and can produce eggs without having a blood meal.

Entomologists employed to control mosquitoes must be able to identify each adult mosquito seen, and know exactly where their larvae will be found. If those larvae can then be killed, the emergence of adults that would otherwise be feeding on blood (and perhaps transmitting diseases), will be prevented. Unfortunately, even after the habitats are located, it may now be impossible to control the blood-sucking pests, because environmental regulations restrict all water management procedures, and prohibit the addition of effective chemicals to the water or air. The

introduction of minnows to destroy the mosquito larvae may also be prohibited, because those minnows also eat other small aquatic invertebrates, some of which have been listed by the EPA as "endangered" or "threatened" species. Any alteration of their "critical habitat" is also illegal under the EPA's Endangered Species Act.

### Anti-malaria Medications

*Tropical Disease Research (TDR) News*, Feb. 2000, reports that antimalarial chemical medication might either (1) destroy the sporozoites or merozoites in human blood, or (2) destroy some of the plasmodia in human liver cells.

More than 300 years ago, human beings knew how to prevent malaria by eating the bark of a specific kind of tree in what is now South America. As *Natural History* reported in October 1989, Incas told missionaries in Peru in the 1630s, that the bark of the Cinchona tree could prevent them from getting malaria, if they ate small amounts of it daily. Two-hundred years later, quinine was discovered to be the chemical in Cinchona bark that was so effective in preventing malaria symptoms.

Natives in Peru and Bolivia engaged in the bark trade, getting about \$15 for a hundred pounds of bark. Some seeds were smuggled out and planted in Java, where selective breeding developed trees with bark containing 15 percent quinine. Eventually Java produced more than 95 percent of the world's quinine, but early in World War II Japan occupied Java, after which the quinine was no longer available to other countries (see *Natural History*, Jan. 1948 for details).

Quinine is now readily available, but the bitter 0.6 gram quinine pills must be swallowed every day, and they cause ringing of the ears, kidney damage, and (sometimes) black-water fever. The quinine kills merozoites, but only some sporozoites.

To replace quinine, the Germans manufactured atabrine in 1936. It caused no ringing ears and no kidney damage, but



caused skin to turn yellow for months afterward. The big pills, which were only taken once a day, killed the merozoites in red blood cells.

Another ancient malaria medication comes from China. For hundreds of years, Qinghaosu (Artemisinin) was a popular medication in China, but not elsewhere. It is derived from the leaves of a common composite weed named Sweet Wormwood, *Artemisia annua* (L.) and was described in a 1527 treatise on Chinese herbs by doctor Li Shi-ze. (This is reported in *Natural History*, Oct. 1989.) There are about 400 species of *Artemisia*, but of the 100 species tested, only *A. annua* was found to produce the curative chemical, Artemisinin. Artemisinin has been synthesized by chemists in Switzerland, the United States, and China, but the cost is considered to be too expensive for mass production.

Clinical trials in China suggested that injectable Artemisinin could cure as many as 90 percent of cerebral malaria cases. Safety data are not yet complete, and the World Health Organization has expressed concerns about possible neurotoxicity in animals. Donald E. Davidson (of the Tropical Disease Research staff) says that qinghaosu has the structure of a sesquiterpene lactone, with an internal peroxide linkage. It may be recommended, either by tablet or injection, for malaria victims who can not tolerate quinine. Tests indicate fetal toxicity in rodents, so its use is discouraged in pregnant women. Two derivatives, Artemether and Artesunate, are more water soluble than the parent compound, but the developer of Artesunate, Nicholas White, warns that it may have neurotoxic effects at high doses (injury to the brainstem).<sup>5</sup>

Other antimalaria drugs were developed, each with different properties:

- Primaquine (1940s) kills gametocytes in human blood, as well as destroying merozoites before they get from the liver into the blood.

- Chloroquine and Amodiaquine kill the plasmodia in the red blood cells. In the early 1950s, Americans developed chloroquine compounds: hydroxychloroquine (plaquenil) and chloroquine phosphate (Aralen). In Cambodia and in Brazil, chloroquine was sometimes added to salt, which was given free to natives and protected them from malaria. Both chloroquine and quinine block the removal of heme, which is a by-product of hemoglobin degradation, and is toxic to plasmodia.

- Chloroquine phosphate (Aralen) was the preferred anti-malaria protection for decades. The small pill was taken once a week, beginning two weeks before entering the jungles and continuing for six weeks after returning. It was widely used, until it lost its effectiveness in the late 1990s. Aralen suppressed vivax, ovale, and malar-

iae plasmodia, and entirely cured falciparum malaria until a resistant strain appeared in Vietnam in 1955.

If falciparum malaria becomes resistant to chloroquine, treatment goes immediately to quinine therapy (2 grams a day for at least four days, but some falciparum are also resistant to quinine.)

In 1967, the U.S. government was screening 60 to 70 new chemicals and spending more than \$11 million seeking drugs that might prevent or cure resistant falciparum malaria. Here are some of the results:

- Fansidar is a 1970s combination of pyrimethamine and sulfadoxine. These antimetabolites kill the sporozoites before they reach the liver. Until recently, Fansidar was recommended for protection, but it has caused severe allergic rashes in a few people.

- Mefloquine (Lariam) was approved in 1989 by the United States for malaria control. Taken once a week, it is a potent killer of merozoites, but about 20 percent of takers may suffer unpleasant symptoms such as nausea, dizziness, vivid dreams, hallucinations, and severe attacks of anxiety. It has a half life of about 21 days in the human body.

Despite all these anti-malaria substances, the U.S. Centers for Disease Control stated bluntly:<sup>6</sup> "Travellers must be informed that regardless of the malaria prophylactic regimen employed, it is still possible to contract malaria." And the research continues. In 1999, a WHO-funded agency, Medicines for Malaria Venture (MMV) was established. It had a budget of \$4 million (in 2000), and its goal was \$30 million a year, which, the director said, "is enough to produce one new antimalaria drug every five years."<sup>7</sup> If adequately funded, this group intends to decode mosquito genomes and pathogenomics and seek new approaches for drug discovery.



Pan American Health Organization/World Health Organization

*Anti-malarial spraying in Guyana. The British medical journal The Lancet reported that no adverse effects of DDT were ever experienced by the 130,000 spraymen or the 535 million people living in sprayed houses during 1959.*

The U.S. Centers for Disease Control in Atlanta stated that it receives 1,000 to 1,500 reports a year of travellers accidentally bringing malaria into the United States. This may result in malaria surprising victims who have never left the United States—as happened recently in Loudoun County, Virginia. In 1952, a Korean war veteran had a malaria relapse while camping near a Girl Scout camp in Nevada County, California. As a result, 35 of the scouts got vivax malaria.

## DDT: Safe, Effective, and Inexpensive

To control *Anopheles* mosquitoes, DDT was sprayed on inside walls once or twice a year. In 1959, spraymen applied 60,000 tons of DDT to the inside walls of 100 million houses. There was never any need to wear masks or protective clothing while doing DDT spraying. No adverse effects were ever experienced by the 130,000 spraymen or the 535 million people living in the sprayed houses.<sup>8</sup>

In house spraying, the amount applied was 2 grams of DDT per square meter of wall, every 6 months.<sup>9</sup> Also, no wildlife was injured by DDT in those areas. The World Health Organization Director concluded, "The discontinuation of the use of DDT would be a disaster to world health."

Montrose Chemical Company workers in California, who wore no masks or goggles, were never harmed by their constant exposure to DDT. When their fatty tissues were analyzed, they were found to contain up to 647 parts per million (ppm) of DDT residues. The fatty tissues of the general population at that time contained only 5 or 6 ppm of DDT.<sup>10</sup> There were *no* cancer cases in those workers, even after 1,300 man-years of heavy daily exposure to DDT. Dr. Edward R. Laws, of the U.S. Public Health Service, found that those Montrose workers still were healthy after 10 to 20 years of that exposure.

In addition to its effectiveness, DDT is inexpensive. The cost of spraying in 1959 was \$205,000, but if substitutes had to be used, malathion would have cost \$637,000, and propoxur would have cost \$1,762,000 for the same control. A 1.5 oz. whisky jigger full of 70 percent wettable DDT covers 144 square feet of wall surface, killing all mosquitoes that land there during the next six months.

In the 1960s, the World Health Organization tested more than 1,300 pesticides, seeking effective substitutes for DDT in mosquito control. Only four approached DDT's effectiveness: Malathion, Aprocarb (Baygon), fenthion, and fenitrothion, but all were more hazardous to humans than DDT and were 4 to 20 times more expensive than DDT.<sup>11</sup>

Because, over the years, I kept hearing propagandist claims that DDT is toxic to people, I studied all of the relevant scientific and medical literature. Here I mention only some details on DDT's safety:

### Evidence That DDT Fights Cancer

- Dr. Edward R. Laws experimentally transplanted malignant tumors directly into rodent brains to deter-

mine the effects of DDT in their diet. Rodents without DDT in their diet all died, but nearly half of the DDT-dosed rodents survived and the cancers disappeared from their brains.<sup>12</sup>

- Drs. Charles Salinskas and Allan E. Okey reported that DDT in rodent diets inhibited development of induced mammary cancers and leukemia.<sup>13</sup>

- A.E. and E.K. McLean determined that after animals had ingested DDT, the highly toxic aflatoxins they had been fed were not fatal, perhaps because they were converted to non-toxic metabolites by the liver.<sup>14</sup> DDT was also known to induce the formation of hepatic microsomal enzymes which, in turn, inhibited the growth of tumors and cancers.

Dr. Wayland Hayes performed tests for the U.S. Public Health Service, feeding human volunteers up to 35 milligrams of DDT in their food every day for 18 months. (The average human intake of DDT in the United States at that time was about 0.03 mgs per day, or 0.36 mgs per year.)<sup>15</sup> No adverse effects resulted, either at the time of the study, or during the next 10 years.

As a result of such studies, I felt that it was safe for me to

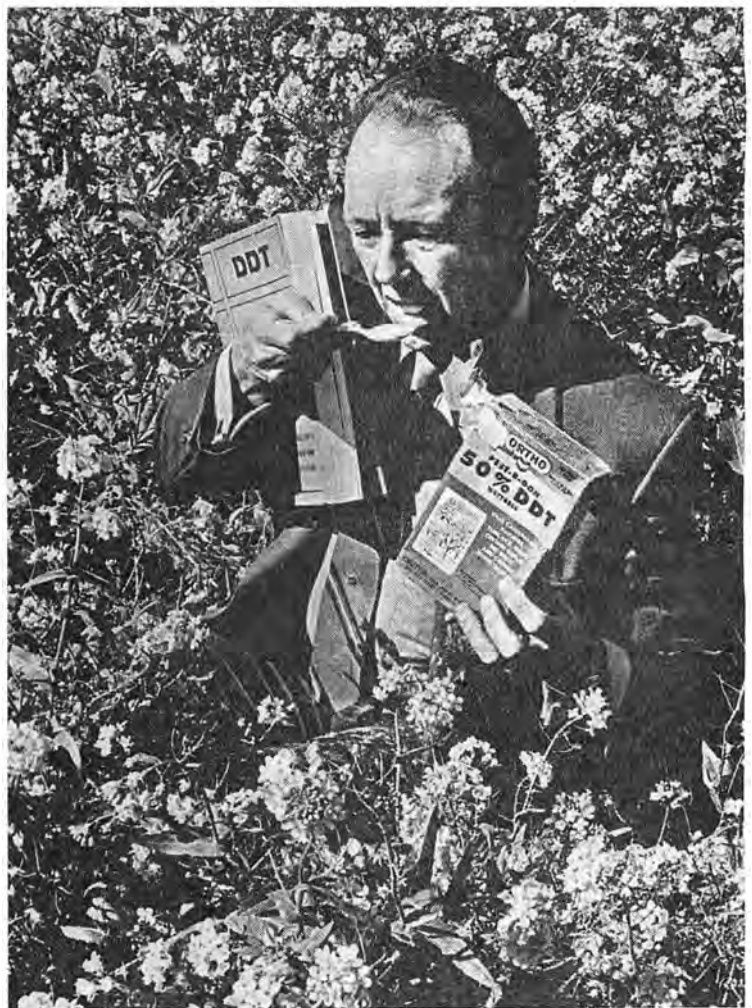

Courtesy of J. Gordon Edwards

*The author, featured in Esquire magazine, September 1971, eating a tablespoon of DDT, a feat he repeated publicly almost every week in his public campaign to show the safety of DDT.*

ingest DDT. I was delivering addresses to various audiences almost every week. I carried a commercial box of DDT onto the stage, dug out a tablespoon of DDT (about 12 mgs), swallowed it, and washed it down with water before beginning my talk about DDT's lack of toxicity to vertebrate animals. *Esquire* magazine, in September 1971, pictured me ingesting a tablespoon of DDT. The text explained that I had "eaten two-hundred times the normal human intake of DDT, to show it's not as bad as people think."

At the same time, the pseudo-environmentalists were going wild against DDT. Clifton Curtis of the World Wildlife Fund, for example, wrote that "DDT is so potent that as long as it is used anywhere in the world, nobody is safe"—and provided no data to back up his assertion. Dr. Gilbert L. Ross, of the American Council on Science and Health, characterized Curtis's remarks as "typical of the dangerous environmental disinformation masquerading as science that has been stirring DDT hysteria ever since the 1960s." Ross pointed out that "Extensive scientific studies have not found any harm to humans, even during the massive overuse of DDT in agriculture in the 1950s and 60s." Furthermore, the scientific reports show that there is *no* indication of DDT use harming people, birds, bird eggshells, or other vertebrate animals.<sup>16</sup>

During the 1960s, the World Health Organization proposed the possible eradication of malaria, worldwide, and malaria control was achieved in areas with a population of 279 million people. Thirty-six formerly malarious countries totally eradicated the disease. The U.S. National Academy of Sciences stated in 1970:

To only a few chemicals does man owe as great a debt as to DDT. In little more than two decades DDT has prevented 500 million human deaths, due to malaria, that would otherwise have been inevitable.<sup>17</sup>

### Then, Along Came Rachel Carson

Then, along came Rachel Carson and her book, *Silent Spring*. She advocated a halt to most uses of pesticides, especially DDT. She stated:

Only yesterday mankind lived in fear of scourges of smallpox, cholera, and plague. Now our major concern is no longer with the disease organisms; better living conditions and new drugs have given us control over infectious disease.

Some of the infectious diseases that Carson ignored, which were *not* controlled, were malaria, typhus, yellow fever, plague, dengue, encephalitis, sleeping sickness, river blindness, leishmaniasis, and elephantiasis—all of which had been locally controlled by DDT.<sup>18</sup>

The president of a leading British scientific organization stated in his inaugural address to the British Agrochemical Association, May 13, 1980, that "If there had been a world ban of DDT, as many sought, then Rachel Carson and her book, *Silent Spring*, would now be killing more people every year than Adolf Hitler killed during his entire holocaust." Unfortunately, in the year 2002, Carson's death toll has now far surpassed that of Hitler, and a world ban on DDT is still the

goal of many pseudo-environmentalists.

On the first page of her book, Rachel Carson dedicated *Silent Spring* as follows: "To Albert Schweitzer, who said 'Man has lost the capacity to foresee and to forestall. He will end by destroying the Earth.'" Because the major theme of her book was anti-pesticide (especially anti-DDT), her dedication seemed to indicate that the great man opposed the use of DDT. However in his autobiography, Schweitzer wrote: "How much labor and waste of time these wicked insects do cause to us . . . but a ray of hope, in the use of DDT, is now held out to us." Schweitzer was worried about nuclear warfare, rather than DDT!

The Environmental Protection Agency supported Rachel Carson at the time, and appeared to be determined to ban DDT. In 1971-1972, the EPA supervised seven months of hearings, which it hoped would have that result. Testimony by scientists before EPA Hearings Judge Edmund Sweeney filled more than 9,000 pages. In his final official decision, issued on April 26, 1972, Judge Sweeney stated:

DDT is not a carcinogenic, mutagenic, or teratogenic hazard to man. The uses of DDT (under the regulations involved here) do not have a deleterious effect on freshwater fish, estuarine organisms, wild birds, or other wildlife. The evidence in this proceeding supports the conclusion that there is a present need for the essential uses of DDT.

EPA administrator William Ruckelshaus never attended a single day of those seven months of expensive EPA hearings, and his aide, Marshall Miller, reported that he did not even read the transcript.<sup>19</sup> Nevertheless, he overruled his own judge's decision and single-handedly banned DDT.

In his "Final Opinion and Decision" on DDT, EPA Administrator Ruckelshaus not only omitted the scientific data which had so deeply impressed the EPA judge, but his own "decision" was padded with propaganda from Environmental Defense Fund literature that appeared nowhere in the entire transcript of the hearings. Ruckelshaus, it should be noted, was a member of the Environmental Defense Fund and solicited donations for that group on his personal stationery.

I summarized a few of the obvious misstatements in Ruckelshaus's "Final Opinion and Decision" on DDT, and Senator Barry Goldwater entered that summary in the *Congressional Record*.<sup>20</sup>

On page 1 of his Final Opinion, Ruckelshaus erroneously wrote: "DDT is the familiar abbreviation of the chemical (1,1,1-trichlorophenyl ethane)." The chemical is actually: 1,1,1-trichloro-2,2, bis(p-chlorophenyl) ethane. On page 4, Ruckelshaus stated, "DDT has three major breakdown products: DDA, DDE, and DDD; separate registrations exist for TDE (DDE)." The truth is, that TDE is another name for DDD, not DDE, and that DDE is not insecticidal at all, thus no registrations for it ever existed.

These cited errors are significant only as an indication of the Opinion's slovenly attention to details. On page 37, Ruckelshaus stated that farmers should use "the less acutely toxic organophosphates, like carbaryl." Even Ruckelshaus should have known that carbaryl is not an organophosphate

pesticide, and that carbaryl and organophosphates are *not* less toxic than DDT! Remember Ruckelshaus's response during the Nixon Administration, when the Secret Service exposed his lies about "arm-wrestling with them" to get papers from Ehrlichman's file cabinet? His defense was: "My allusion to arm wrestling was an effort at hyperbole at a time when reality could not absorb exaggeration. The gloves were never donned and the bell never sounded. . . in short, the bout never occurred."<sup>21</sup>

EPA officials vigorously denied that the ban was political, but on April 26, 1979, Ruckelshaus himself wrote a letter to Allan Grant, President of the American Farm Bureau Federation, in which he stated: "Decisions by the government involving the use of toxic substances are political with a small 'p.' . . . Science, along with other disciplines such as economics, has a role to play, but the ultimate judgment remains political."

Other apologists for Rachel Carson and the Environmental Protection Agency have contributed remarkable statements to the mythology about DDT and malaria. To take one example: In *Science* magazine, Oct. 10, 1997 (page 223), Jacob Koella and Margaret Mackinnon wrote: "Most mosquitoes die when they bite someone, and get squashed. It thus makes sense for a mosquito to keep its biting to a minimum. It might also make sense for the malaria parasite to want its insect host to behave with some restraint, as the longer the insect is alive the more opportunities the parasite has to be transmitted."

In fact, Koella says, "the malaria plasmodium wants the mosquito to bite as often as possible." Perhaps other such writers can conduct more personal interviews with protozoans and mosquitoes, and pass their opinions along to scientists in future issues of *Science* magazine?

## The Death Toll of the Anti-Pesticide Lobby

Pesticides, which protect human lives and increase the crop yields, have for this very reason been targeted by the anti-population environmentalists for attack. The U.S. Export/Import Bank financed more than \$3 billion worth of pesticide exports in 1974-1976, saving millions of human lives. In 1970, the National Audubon Society distributed 17,000 yellow leaflets bearing the message: "DDT should be



Stuart Lewis/EIRNS

*Environmental Defense Fund activist William Ruckelshaus singlehandedly banned DDT in 1972, without reading one word of testimony from the seven months of hearings conducted by the Environmental Protection Agency, which he headed.*

banned throughout the land, and banned from export." In 1976, the Audubon Society and the Natural Resources Defense Council sued in federal court to prevent more pesticides from being shipped to undeveloped countries. The National Legal Center for Public Interest opposed that suit, and four years later the court finally ruled against the environmental extremists.

In 1977, pseudo-environmentalists again sued to force the Agency for International Development to submit Environmental Impact Studies before pesticides could be sent to save lives in poor countries. This suit was partially successful, and in 1986, the Agency for International Development responded by issuing "Regulation 16 Guidelines." Based on those Guidelines, Secretary of State George Schultz telegraphed orders to U.S. embassies in poor countries, stating that: "The U.S. cannot—repeat cannot—participate in programs using any of the following pesticides: (1) lindane; (2) BHC; (3) DDT; and (4) dieldrin." The poor countries thus either had to survive without U.S. aid or try to get along without the pesticides needed to protect the health of their inhabitants. Hundreds of thousands have starved or

died, as a result.

The U.S. Centers for Disease Control in Atlanta made clear in a July 25, 1969, warning that the ban on DDT would come with a high death toll:

A decision to ban the production of DDT in the U.S. would result in a denial of the use of DDT to most of the malarious areas of the world. The available evidence on the very slight risks, if any, does not justify the U.S. making a unilateral decision that would so adversely affect the future economic and social well-being of so many other nations of the world. The mere banning of the use of DDT within the U.S. may raise unwarranted fears in the minds of those responsible for decision making in other governments who will not be fully informed of the known facts about the benefits and risks involved in the continued use of DDT in malaria eradication.

Other donor countries also frowned on DDT use in poor countries, after the 1972 U.S. ban, and withheld financial aid if those countries used DDT.:

- In Mozambique DDT use was stopped "because 80 percent of the health budget came from donors who refused to

allow the use of DDT" (*British Medical Journal*, March 2000).

- Belize and Bolivia stopped using DDT in their public health programs because they feared the loss of aid from international agencies.

- South Africa also halted its DDT spraying in 1995, after which malaria cases in the country quadrupled to over 50,000, and malaria incidence there has risen by more than 1,000 percent in the last five years.

*International agencies that block aid to countries that use DDT for malaria control should be held responsible for the deaths that result.*

Dr. Donald Roberts, an entomologist and professor at the Uniformed Services University of Health Sciences, at Bethesda, Maryland, has reported in the scientific literature on the efficacy of spraying DDT on the inside walls of houses as a way of combatting malaria. "Malaria rates are climbing in poor countries that stopped using DDT. . . . Rates increased by 12 times in Guyana after DDT spraying was reduced," Roberts wrote. As the figure shows, malaria cases in South America have risen by over 1,000 percent in the past five years. Only Ecuador and Venezuela have contained or reduced malaria in the past few years.

I recently visited Ecuador, to study conditions along Rio Napo. People are responding well to the 61 percent reduction in malaria cases that resulted from three years of DDT programs there. The surrounding countries had stopped their DDT programs three years earlier, and are now suffering up to 91 percent more malaria, as a result, as can be seen in the figure.

Countries that have continued to use DDT have halted their malaria epidemics. In Africa, Swaziland still benefits from DDT spraying (with less than 4 per cent of the residents infected), but just across the border about half of the people in unsprayed South Africa have malaria infections.

In Madagascar, malaria killed more than 100,000 people in 1986-1988. Authorities belatedly began spraying DDT again, and stopped the epidemic.<sup>22</sup>

In response to the resurgence of malaria, and the international environmentalist attempts to ban DDT worldwide, Dr. Roger Bate, chairman of the Save Children from Malaria campaign, warned:

Problems will arise from restrictions on DDT use, but it is of far greater importance that countries can continue to use DDT without fear of reprisals—at least official reprisals. Aid agencies and environmental groups pressuring countries to abandon DDT for public uses could kill thousands of people and cost millions of dollars.<sup>23</sup>

### Willful Genocide

Before DDT was developed, about 10 percent of the people in the world had malaria attacks, and someone died of the disease every 10 seconds. DDT turned this situation around in three decades, but then the U.S. ban in 1972 brought the world back to the pre-DDT days. In 1996, the U.S. National Academy of Sciences reported that:

malaria is affecting 2.4 billion people, or 40 percent of the world's population. A child dies of malaria, some-

where, every 30 seconds, and most of these deaths are unnecessary.

Is the DDT ban intended to control global populations? This question was raised by Paul Driessen, writing in the April 2001 *Environment and Climate News*.

In 1972 the EPA banned all uses of DDT in the U.S. and in any nation receiving U.S. aid. Within just six years, 800 million cases of malaria developed and 8.2 million malaria deaths per year were reported in countries affected by EPA's ban.

In response, many countries wish to turn again to DDT, prompting the World Wildlife Fund and other environmental groups to demand a permanent, inflexible, global ban on this life-saving pesticide. At best, their

*Continued on page 30*

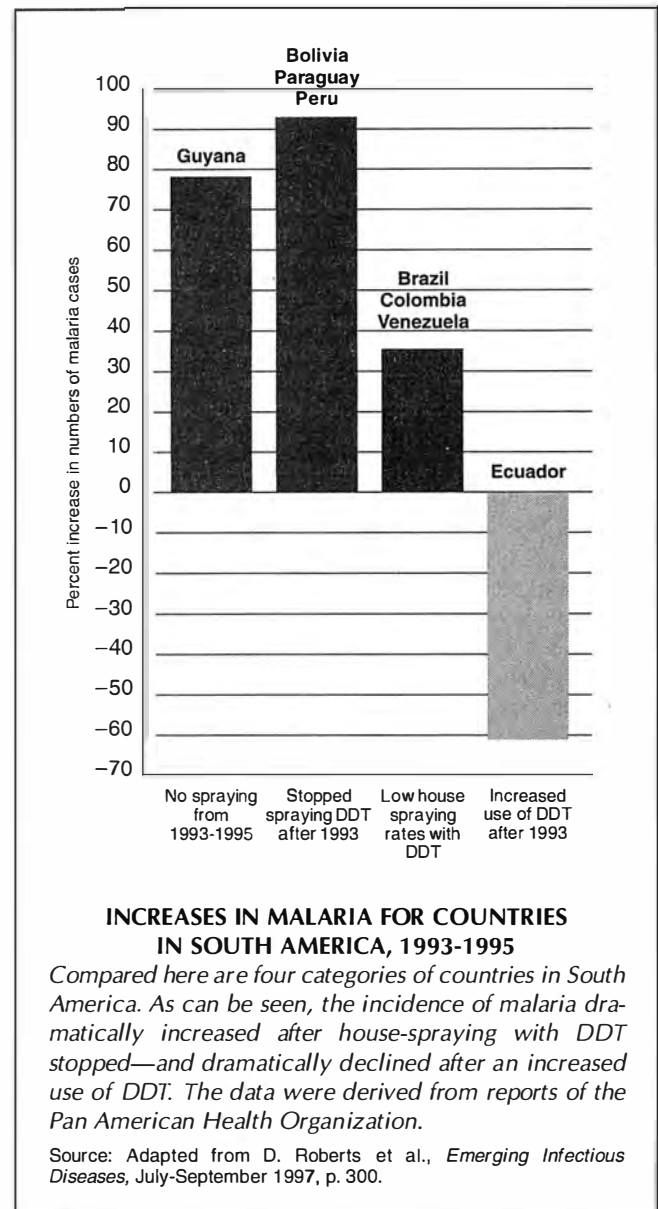

# Vaccine Research: Many Leads, But Little Success

In his book *Malaria Capers*, author Robert Desowitz reports (p. 275) that

After 25 years, the AID [U.S. Agency for International Development] malaria vaccine research project has proven to be a disaster. The failure was primarily due to mediocre science, irresponsible experimental procedures, and corruption. . . .

Another reason may be that the human constitution is such that no vaccine can confer a protective immunity to human malaria.

Malaria vaccine research has been going on since World War II. In 1945, Jules Freund discovered that Rhesus monkeys could be immunized with a vaccine protecting them from *Plasmodium knowlesi*, but only when it was used with an adjuvant. Freund's adjuvant is an emulsified suspension of a killed tuberculosis mycobacterium, in mineral oil. The mineral oil is largely responsible for the adjuvant's toxicity, because it is metabolically inert and cannot be metabolized. The addition of such an adjuvant seemed to stimulate the body's defense system and prevent the malaria from becoming fatal.

For 30 years, Freund's adjuvant was used in malaria vaccine research; however, it was found to cause tumors, abscesses, and other side-effects that were often fatal. In monkeys it produced auto-immune damage to nervous tissues, and half of the monkeys died. It could never be routinely used in human beings and was in fact too harmful to even be tested on humans. As a result, vaccines to protect humans from malaria have been difficult to develop.

In addition, vaccines may be of such short duration that they will be useful primarily to protect travellers. As Doctors for Disaster Preparedness noted in its May 1997 newsletter, "in countries where people cannot even afford mosquito nets, expensive vaccines will obviously be useless."

Researchers seeking vaccines for disease control routinely inject a killed form of the pathogen into the victim's blood. That sometimes causes the body to stimulate the production of chemical defenses. Injecting the killed plasmodia of malaria did not bring about the desired effect, however.

## Probing the Genome

Some vaccine research is focussed on genetic alterations. As reported in *Science News* Feb. 3, 1990, the Institute for Genomic Research is currently trying to crack the entire 30-million-base-genome of *Plasmodium falciparum*. A \$1.1 million dollar program financed by the MacArthur Foundation seeks "to forge a marriage between modern genetics and vector biology, at five U.S. Research Centers." They hope to develop vector incompetence, and stated: "We may enhance populations that are not good disease transmitters, without removing a significant piece of the ecological puzzle."

Meeting at the Pasteur Institute on March 3, 2001, representatives from 20 research centers in 12 countries started laying plans for sequencing the genome of *Anopheles gambiae*.

Revealing the mosquito's 260 million DNA base pair sequence, together with those of *Plasmodium falciparum* (now nearing completion) should open up new strategies for controlling malaria. The cost should run less than \$10 million, say the chief participants. Additional funds will be needed to fine-tune the sequences and begin detailed analyses of the genes and their functions. (See *Science* magazine, March 9, 2001.)

Well-known vaccine researchers Ruth and Victor Nussenzweig identified the primary antibody "target" on attenuated sporozoites, and called it a "circumsporozoite protein (CSP)." They synthesized a portion of that protein and used it as their vaccine. They said a problem is that if just one sporozoite escapes it produces 30,000 merozoites in a week, and they are not affected by the vaccine. There is no known "target" on merozoites. (For a report on the Nussenzweig research, see *Science*, Oct. 20, 2000, pp. 437-439.)

## Patarroyo Results Disappointing

Another well-known vaccine researcher, Dr. Manuel Patarroyo, Director of Bogota's Institute of Immunology, developed a vaccine that is "a combination of four synthetic peptides mimicking surface proteins from both the merozoite and sporozoite stages of *Plasmodium falciparum*." Many scientists were skeptical, and the British Medical Research Council concluded that "the available data are not adequate to justify their support for experiments on humans." Patarroyo did not report any double-blind studies or any experiment in which his treated patients were compared with "controls" receiving placebos.

Dr. Patarroyo has worked for the last 13 years on the production of a vaccine to protect humans from malaria. He recently declined to accept \$8 million from a U.S. company, and instead donated all rights to his vaccine to the World Health Organization, saying "All I wanted to do was to solve a complicated problem and help the poor people of the world." His vaccine, if effective, would cost only about 50 cents for a three-dose regimen. Bogota government officials were ready to begin construction of a \$4 million facility to produce the vaccine, and after six years of skepticism, the United Kingdom Medical Research Council (MRC) endorsed plans for a vaccine trial in Gambia, involving 600 infants less than a year old. The vaccine was not as effective as hoped. The study found that it did not prevent malaria among the vast majority of the 630 Gambian children (6 to 11 months of age) who took part in the study. Only 3 percent of them were protected.

Another line of research has been to develop a kind of sterile mosquito, unable to transmit malaria. In an article titled "Building a Disease-fighting Mosquito," *Science* magazine (Oct. 20, 2000, pp. 440-441) reported how "Several labs have embarked on the most futuristic of all approaches to combat malaria." They hope "to replace billions and billions of mosquitoes in the world's endemic areas with new strains of mosquitoes, created in the lab, that would be 'refractive,' or unable to transmit the parasites." This research is based on

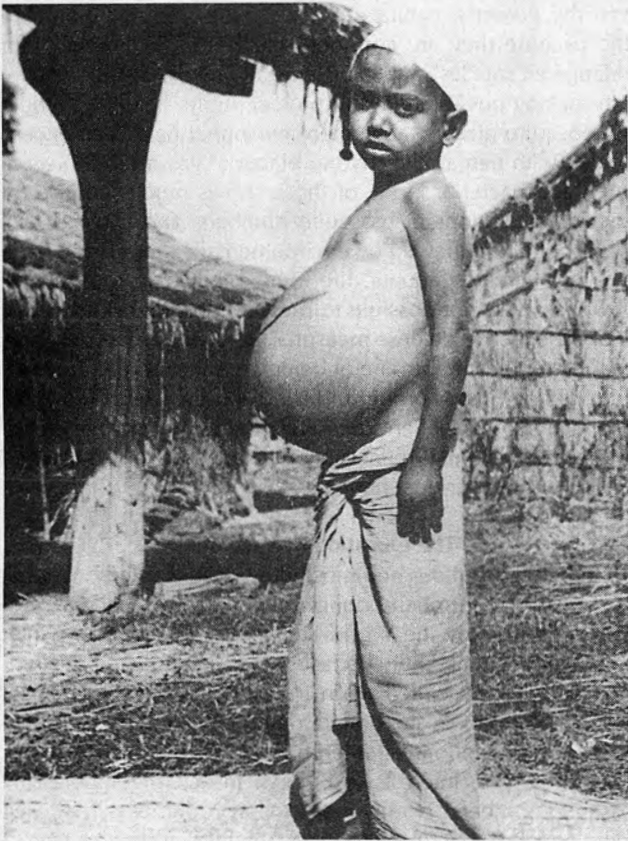

© WHO Photo

*A typical malaria victim in 1950, before DDT was widely used. The child's spleen is enormously enlarged, one of the symptoms of malaria infection.*

the transmission of a chicken parasite by *Aedes aegypti*, where researchers tried to transpose new genes in *Drosophila* (fruit flies) into genetically engineered mosquitoes. However, they couldn't get any genes delivered from *Drosophila* into a mosquito! "It put a cloud over the whole research area," said researcher Anthony James."

Dr. Stephen Hoffman at the Naval Medical Research Center in Maryland is working on a DNA-based vaccine that will attack the parasite before any symptoms emerge. Hoffman says, as reported in *The Smithsonian*, September 2000, the malaria plasmodia have about 6,000 genes in their DNA, compared to common viruses which have fewer than 30. He is hopeful that his and other vaccines "will be ready in 7 to 15 years."

#### **A Record of Fraud**

The search for a malaria vaccine has also been hit with fraud. In 1983, Miodrag Ristic, of University of Illinois, submitted a proposal to the U.S. Agency for International Development, for three years funding of his malaria vaccine research. His budget proposal was for \$2.38 million. The AID expert panel of consultants recommended that it not be funded. However, AID's malaria vaccine project director, James Erickson, approved it, so Ristic got his millions. During the next three years Ristic

transferred \$24,000 to a personal account, and in 1987 investigators found enough fiscal improprieties to warrant criminal investigation by the Attorney General of Illinois. No vaccine was developed, and in 1990, Ristic was indicted on four counts of theft. Erickson was indicted by the grand jury and charged with conflict of interest, conspiracy, illegally accepting gratuities, making false claims, and submitting false income tax returns. He could have been jailed for five years and fined \$250,000 but a lenient court fined him just \$20,000.

Wasim Siddiqui, at University of Hawaii, exploited 1966 research by Martin Young (of the National Institutes of Health), who had reported that the South American owl monkey could be experimentally infected with human falciparum malaria, and 1977 research by William Trager and James Jensen of the Rockefeller University, who found that *P. falciparum* could be grown in a media culture if oxygen was diminished and carbon dioxide was increased in the incubator. Siddiqui immunized owl monkeys with *P. falciparum* cultured in the Trager/Jensen method, and mixed with Freund's adjuvant. The vaccine could never be available for clinical trials, however, because that adjuvant has such severe effects. Siddiqui was later indicted for appropriating \$130,000 through "accounting tricks."

Siddiqui reported that muramyl dipeptide had some of the properties of Freund's adjuvant, but when he tested it on four monkeys, only one monkey survived.

In 1985, Siddiqui requested another \$1.65 million, and AID reviewers rejected his proposal as "mediocre, unrealistic, outlandish, and outrageous," with an "excessive budget." AID malaria vaccine director James Erickson again ignored their evaluation and awarded Siddiqui the total amount requested. Siddiqui then falsely claimed that his vaccine was "almost ready for human use."

In 1988, the AID asked the U.S. Inspector-General to investigate, and those investigators stated that there was "an apparent diversion and theft of funds, submission of false claims, and intent to cover up the actual use of the funds." On Sept. 14, 1989, the Grand Jury of Hawaii indicted Siddiqui with theft, criminal conspiracy, and criminal solicitation. On the very day he was arrested by the Honolulu police the AID Vaccine Research Office announced that it was giving Siddiqui another \$1.65 million to continue his research.

U.S. Senator Inouye then went on television and said that if Siddiqui was handed any more federal funds he personally would see to it that the University of Hawaii would never get another cent of federal research money. The University replaced Siddiqui with a psychologist and a young bacteriologist, and AID found them to be acceptable to carry out the \$1.65 million research program.

*Science* magazine reported (June 4, 1993) that in February 1993, Hawaii's deputy attorney general had closed the case against Siddiqui for misappropriating another \$114,000 in AID research funds. He was sentenced to just six months of house detention, and the university relieved him of teaching duties. University lawyers were attempting to recover an additional \$250,000 which they said he had diverted from university accounts. The university newspaper reported that he was still drawing his salary of \$92,340 a year.

Continued from page 27

campaign suggests a painfully callous indifference to the devastating impact the ban would have on the world's most destitute and disease-ridden peoples.

Many anti-DDT activists seem to believe that the answer to the world population problem is to permit up to half of the people in poor nations to die of malaria. Such a view apparently was shared by Edwin J. Cohn, of the Agency for International Development's Office of Policy Development and Analysis. Referring to the fecundity of many women in poor tropical countries, he said: "Rather dead than alive and riotously reproducing" (as cited in Robert Desowitz, *Malaria Capers*, p. 217).

The environmentalists have been just as blunt.

- When Ethiopia was experiencing a severe famine, David Foreman, of the Sierra Club, said: "The worst thing we could do is to give aid . . . the best thing would be to just let nature seek its own balance, to let the people there just starve." Sierra Club Executive-Director Michael McClosky told United Press International, Feb. 25, 1971, that "The Sierra Club wants a ban, not just a curb, on persistent pesticides, even in the tropical countries where DDT has kept malaria under control."

- Britain's Prince Philip, who, along with his friends, organized and funded the environmentalist movement, is quoted in *People* magazine, December 1981) stating: "I was in Sri Lanka, where malaria was controlled by DDT. What people didn't realize was that malaria was actually controlling population growth. The consequence was that within about 20 years the population doubled."

- Alexander King, the president of the Malthusian Club of Rome, which is active in more than 40 countries, saw the DDT spray program succeed in Guyana, where within two years it had almost eliminated malaria. He wrote in his 1990 book, *The Discipline of Curiosity*, that "my chief quarrel with DDT in hindsight is that it has greatly added to the population problem."

- Environmentalist Jacques Cousteau stated in the *UNESCO Courier*, November 1991: "In order to stabilize world population, we need to eliminate 350,000 people per day. It is a terrible thing to say, but it is just as bad not to say it."

- The newsletter *Earthbound* stated: "Massive human diebacks would be good. It is our duty to cause them. It is our duty to eliminate 90 percent of our numbers."

### Mosquito Control Now Very Difficult

Before the development of the powerful pseudo-environmental lobby, mosquito larvae could be easily controlled by filling puddles, draining swampy breeding sites, and adding appropriate chemicals to the water. But now, effective control by water management operations has been made illegal by the so-called environmentalists. We cannot legally alter mosquito larvae habitats, because of the Clean Water Act, the Wetlands Protection Rules, and the Endangered Species Act. We cannot put oil or synthetic chemicals in ditches or puddles, because of the Clean Water Act. We cannot spray pesticides into the air, because of the Clean Air Act.

Most synthetic insecticides have been banned, or criticized so violently that their application is opposed. Environmentalists even oppose the introduction of surface-feeding minnows (because they may also eat other forms of aquatic life, some of

which are protected as "endangered" or "threatened" species). Even the *potential* habitats for mosquitoes are now untouchable because they are considered to be "critical habitats for endangered species" and cannot legally be disturbed.

In seeking possible ways to protect public health by reducing mosquito attacks, abatement personnel have also experimented with nematodes, hydra, planaria, gregarine protozoa, fungi, and bacteria. None of those shows much promise for practical reductions of mosquito numbers, and every one of them could be outlawed by environmental extremists because they may threaten aquatic life forms other than mosquitoes. Obviously, it is not possible to prevent mosquito outbreaks if all of the effective defense measures are banned. The only protections people can be sure of being permitted to use are mosquito netting, insect-proof buildings, and the use of mosquito repellents. Even repellents are likely to be banned, because of adverse or potential effects on endangered or threatened species or their "critical habitats."

### The Question of Vaccines

If killing mosquitoes and mosquito larvae is ruled out, what else is there? The much-publicized "Roll Back Malaria" program, instituted by the World Health Organization in winter 1989, stressed that "the emphasis is on dialogue and flexibility." Countries are called upon to "stimulate development of vaccines," and to "foster collaboration between institutions to ensure full utilization of research knowledge and programme experience." No interest was shown in actually suppressing mosquito numbers! Twenty four African countries participated in the program, but 26 did not. Meanwhile, under this type of approach, malaria has *not* been rolled back.

What about vaccines? The situation in brief can be seen in the comments of *Science* magazine, Sept. 26, 1997: "Last spring, 134 potential vaccine research groups were seeking \$130 million. . . . Since only \$2 million was available, not much resulted." In 1983, the Agency for International Development (AID) stated that many malaria vaccines would soon be ready for testing. They were obviously wrong, since not a single successful vaccine has been developed by the year 2002!

The problems in developing a malaria vaccine are daunting. (See Box, p. 28.) As one researcher, James Jenson of Brigham Young University, put it, "Malaria is thousands of times more complex than anything else we've ever tried to make a vaccine for." Unfortunately, malaria plasmodia mutate rapidly, which would probably limit the usefulness of any vaccine that is developed.

A vaccine must attack each of the very different stages in the *Plasmodium* life cycle, to be effective. Furthermore, the four species of *Plasmodium* that can cause human malaria differ in many ways. *Plasmodium vivax* and *P. ovale* are relatively mild forms, but *P. falciparum* is a violent killer, with attacks every 48 hours, and *P. malariae* causes attacks only every 72 hours. Any single vaccine obviously can not protect humans from all malaras. It is also the case, as pointed out by researcher Stephen Hoffman, that a 6-year old boy in Africa "may have as many as five different strains of malaria existing at once within him, and you must have a vaccine that attacks all five."

A recent National Institutes of Health report states that it would take more than \$250,000,000 and a dozen years to



develop a vaccine and get it licensed. NIH stated that "large-scale clinical trials are still a distant dream of malaria vaccine researchers." Those millions of dollars already appear to be inadequate!

It is hard to believe, but the *Tropical Disease Research News* (Feb. 2000) stated that "Malaria vaccines represent one of the most cost-effective interventions for reducing the burden of malaria." That view on the cost-effectiveness of producing vaccines borders on criminality! The costs have been exorbitant and there is no imminent help for the millions of humans who so desperately need protection.

### Expensive Malaria Research—But No DDT

As malaria has continued to spread, new malaria research programs and new funding have emerged—but there is no mention of effectively killing mosquitoes using DDT or other effective insecticides.

A news article (*Science*, Oct. 20, 2000, pp. 428-431), titled "A Renewed Assault on an Old and Deadly Foe," reports that the World Bank is pledging \$300 million in interest-free loans to fight malaria, the Bill & Melinda Gates Foundation is donating \$115 million, and the National Institute of Allergy and Infectious Diseases budget is expected to raise more than \$52 million in 2001.

In 1998, the World Health Organization allocated \$10 million "to help countries develop plans for tackling malaria, training staff, and initiating more effective action." WHO stated, "it is not going to be easy; however the potential is there, and if the scientific and technical inputs can be channeled through effective health systems and supported by adequate finances and political commitment, the benefits for the poor of the world will be enormous." But, WHO did not allocate any funds to help those countries control the numbers of larvae and adult mosquitoes in those suffering areas!

Under the directorship of Gro Harlem Brundtland, the WHO announced a crusade to "reduce malaria over the next 10 to 15 years." Her goal was not the eradication of malaria anywhere, but just "to halt half of the malarial mortality by 2010 and half again by 2015." (This was reported in *Emerging Infectious Diseases*, July 1997.) Apparently Brundtland will be content if only one child died of malaria every minute (instead of two) and if one person dies every .24 seconds

(instead of one every 12 seconds)! And what of the 500 million cases of malarial sickness? Will she continue to ignore millions of deaths, with no intention of saving them?

At a meeting sponsored by the National Institutes of Health, the Fogarty International Center, the Gates Foundation, Tropical Disease Research, and the WHO it was stated that "with adequate support, the necessary field testing of candidate vaccines could be achieved in five to ten years," at which point, "industry might be induced to come on board, provided the required milestones are met."

Participants at the meeting said that "within 10 to 15 years, licensing and deployment of vaccines could be feasible, given sufficient backing." (In other words, these groups also favor another 10 to 15 years with no effective relief from mosquito-borne diseases.)

It must be remembered that during 7 years, 21 million more humans will die of malaria, and in 15 years the total will be 45 million more deaths that could have been saved if adequate mosquito control programs had been carried out during those years of vaccine research.

## The POPs Treaty Kills

In the 1990s, the United Nations Environment Program (UNEP), with the collaboration of many environmentalist Non-governmental Organizations, proposed a world phaseout of



Illustration by P. Emerson

Rachel Carson and her book that launched millions of deaths.

POPs (Persistent Organic Pollutants), targeting the so-called "Dirty Dozen Chemicals." UNEP proposed an international treaty to ban or phase out 12 chemicals, including 8 insecticides (aldrin, chlordane, DDT, dieldrin, endrin, heptachlor, mirex, and toxaphene). All are categorized as chlorinated hydrocarbons. Also targeted are PCBs, hexachlorobenzene, dioxins, and furans.

The POPs treaty grew out of earlier agreements spawned at the 1992 Earth Summit in Rio de Janeiro, particularly the United Nations manifesto known as Agenda 21. At the United Nations Convention on Persistent Organic Pollutants, 600 activists assembled in Johannesburg, South Africa, in 2000, to urge banning the "Dirty Dozen" chemicals.

The POPs Treaty was formally adopted at a Conference in Stockholm on May 23, 2001. After 50 governments have ratified it, the treaty will enter into force. At least 23 countries voted against banning DDT, and requested exemptions for usage of DDT for public health purposes. Initially, the Treaty sought to permanently ban eight chlorinated pesticides, but, to the relief of many public health experts who fought the ban, it permitted the limited use of DDT where it is needed for malaria control.

In 1972, politics and anti-population policy were allowed to determine the banning of DDT in the United States—a decision that has caused the deaths of millions and the suffering of many more millions. Thirty years later, will this nation, now in the throes of the mosquito-borne West Nile virus, wake up to the folly of this decision and bring back DDT?

*Entomologist J. Gordon Edwards is emeritus professor of biology at San Jose State University in California, where he taught for more than 40 years. He is a long-time member of the Sierra Club and the Audubon Society, and is a lifetime fellow of the California Academy of Sciences. He is also the author of several ornithological articles published by the Audubon Society and other environmental groups.*

*This article was adapted from remarks prepared for presentation at a meeting of Doctors for Disaster Preparedness in Las Vegas, July 15, 2001.*

#### General References

- California Department of Agriculture, March 1980. Mosquito Research, Special Report, 43 pages.
- E.C. Cushing, 1957. *History of Entomology in World War II*, Washington, D.C.: Smithsonian Institution Publ. 4294, 117 pages.
- R. Desowitz, 1992. *The Malaria Capers*, New York: H. H. Norton.
- J.G. Edwards, 1993. "Malaria, the Killer That Could Have Been Conquered," *21st Century*, Summer.
- B.F. Eldridge and J.D. Edman, 2001. *Medical Entomology*, New York: Kluwer Academic Publishers.
- Natural History Magazine*, 1991. Twenty articles on mosquitoes (July).
- U.S. Navy Medical Department, 1984. "Guide to Malaria Prevention and Control," Norfolk, Va.: Navy Environmental Health Center, 90 pp.
- D.R. Roberts et al., 1997. "DDT, Global Strategies, and a Malaria Control Crisis in South America," *Emerging Infectious Diseases*, pages 295-302.
- R. Tren and R. Bate, 2000. "When Politics Kills: Malaria and the DDT Story" (Washington, D.C.: Competitive Enterprise Institute, 52 pp.).

#### Notes

1. Joseph J. Jacobs, 1991. *The Anatomy of an Entrepreneur* (ICS Press), pp. 84-87.
2. *Science* magazine, June 9, 1972.
3. See U.S. Army Yellow Fever Commission, in U.S. Senate Document No. 822 (Jan. 27, 1911) for details.
4. See *Natural History*, July 1991.
5. In an article titled "Reinventing an Ancient Cure for Malaria" (*Science* Oct. 20, 2000, pp. 437-439), it is reported that "Resistance is making every anti-malarial drug useless. Nicholas White, in Bangkok, expresses hope for Artemisinin, extracted from *Artemisia annua*, that has been used as a malaria remedy in China for nearly 2,000 years." A report in *The Lancet*, July 22, 1994, stated that Artesunate was nearly 100 percent effective, when combined with mefloquine.
6. *Morbidity and Mortality Weekly Report*, April 12, 1986, p. 1.
7. *TDR News*, Feb. 2000 and *Science*, March 17, 2000.
8. *The Lancet*, July 15, 1972.
9. *The Lancet*, July 22, 2000.
10. *Arch. Environmental Health*, Vol. 15, pp. 768-75 (1967).
11. WHO Press Release, July 16, 1969.
12. *Arch. Environmental Health*, Vol. 23, pp. 181-84 (1971).
13. *J. Amer. Medical Assn.*, Vol. 162, pp. 890-97 (1956).
14. *J. National Cancer Institute*, Vol. 55, pp. 653-57 (1975).
15. According to Wayland Hayes, writing in *Hospital Practice* (October 1969), "0.03 mgs for a 68 kg man (150 lbs) is the present daily intake" of DDT.
16. Curtis's allegation is thoroughly refuted, among other places, by Claus and Bolander, on pages 288 to 550 of their carefully researched book, *Ecological Sanity*, published by David McKay Company, 1977.
17. National Academy of Science, 1970. In *The Life Sciences*, Washington, D.C.
18. See the author's article "The Lies of Rachel Carson," *21st Century*, Summer 1992, pp. 41-51.
19. *Santa Ana Register*, April 25, 1972.
20. *Congressional Record*, July 24, 1972, pp. S11545-47.
21. EPA Radio Broadcast, May 15, 1975.
22. *J. Amer. Mosquito Control Association*, 1998, pp. 121-130.
23. *Environment and Climate News*, April 2000..

## Special DDT collection

### The Lies of Rachel Carson

by Dr. J. Gordon Edwards, Summer 1992, pp. 41-52

### DDT, *The New York Times*, and Judge Irving Kaufman

by Thomas H. Jukes, Spring 1992, pp. 8-10

### Malaria: The Killer That Could Have Been Conquered

by Dr. J. Gordon Edwards, Summer 1993, pp. 21-35

### *Silent Spring* and the Betrayal of Environmentalism

by Dr. Thomas H. Jukes, Fall 1994, pp. 47-54

**4 photocopied articles—\$15.00 (postpaid)**

Purchase by credit card at

[www.21stcenturysciencetech.com](http://www.21stcenturysciencetech.com)

or send check or money order to

**21st Century**

P.O. Box 16285, Washington, D.C. 20041

# To Control Malaria, We Need DDT!

*A malaria-control specialist explains why house spraying with DDT is the only effective method for combatting malaria today.*

The following is adapted from a presentation by Donald R. Roberts, Ph.D., Professor of Tropical Public Health at the Uniformed Services University of the Health Sciences in Bethesda, Maryland. Roberts's talk, titled "DDT and Malaria Control: Past, Present, and Future," was given to a conference sponsored by Accuracy in Media in Washington, D.C., in October 2002. His views do not represent the official position of the University, the Department of Defense, or the U.S. Government.

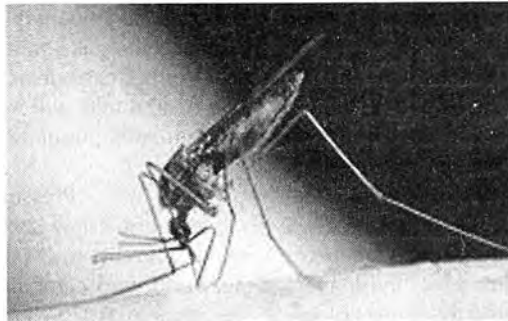

---

**"DDT became an overnight success in the mid-1940s because it was cheap and relatively safe."**

---

Rural malaria was a major public health problem prior to the mid-1940s, even in the United States. With the advent of DDT, the era of uncontrolled malaria ended, followed by decades of dramatic control or elimination of both urban and rural malaria. Unfortunately, those marvelous achievements were lost as countries complied with international pressures to abandon DDT and house spray programs. . . .

There are many modern insecticides that might be used as substitutes for DDT, but they are not cheap and do not have a long residual action. The frequent re-spraying of chemicals with short residual activity (DDT alternatives) is not an affordable method of malaria control in rural areas. Thus, as developing countries were forced to abandon house spray programs, they gradually reverted to the conditions of uncontrolled rural malaria that existed before the mid-1940s.

Today, the fundamental relationship of malaria with rural people, and the economics of using house spraying to control mosquitoes in rural environments is "old" knowledge that needs to be relearned.

## Major Anti-DDT Myths

The idea that malaria should be controlled by integrating many methods of mosquito control (integrated vector control, or IVC), as opposed to spraying walls with DDT is erroneous.... In fact, IVC is relatively unproven as a broadly affordable and applicable approach to malaria control. IVC methods are particularly irrelevant in rural areas with small numbers of humans surrounded by large areas of mosquito habitat.

Regardless, anti-DDT groups have used the IVC concept to pressure developing countries to stop spraying DDT.

Another favored ideology of environmental activists is that any use of insecticides is counterproductive, because it results in resistant mosquitoes. In fact, there is little evidence that

insecticides on house walls constitute a strong selective pressure for insecticide resistance. Likewise, there is little evidence that resistance, once developed, reduces the effectiveness of DDT residues in preventing indoor transmission of malaria.

To put these observations into perspective, it is important to understand that DDT became an overnight success in the mid-1940s because it was cheap and relatively safe. There were many chemicals much more toxic to insects than DDT (for example, nicotine); but they were also toxic to humans. Even for insects, DDT exhibited only a slow toxic action. The

real secret of its marvelous benefit was powerful action as a non-contact repellent and a contact irritant.

DDT's repellent/irritant properties were first described in 1945, and were clearly recognized before the first instance of DDT resistance was even reported. To understand how DDT's repellent and irritant actions function to prevent malaria transmission, we need to understand some basic facts about behavior of malaria mosquitoes.

## How Mosquito Transmission Works

Malaria transmission occurs by mosquitoes moving to houses, entering during the early evening, resting indoors and, at some point during the night, landing on humans and biting. During the act of biting, the mosquitoes might acquire malaria parasites and become infected, or if already infected, they might transmit malaria to another human.

DDT residues on house walls can alter this sequence of mosquito behavior. The non-contact repellent action of DDT residues can prevent a malaria mosquito from entering a house. If the mosquito enters, in spite of repellent action, then the contact irritant action might cause it to exit before biting. If the contact irritant action fails, then contact toxicity might still result in mosquito death, after prolonged contact with DDT-treated surfaces.

However, to actually understand how it works we must think in terms of probabilities of events, and introduce the multiplication law of probabilities. Let's *assume* that each of the three actions (repellent, irritant, and toxic) function at a level of 50 percent. Let's also assume that there are 100 mosquitoes that will enter a house if it is not sprayed. If the house is sprayed, 50 percent will not enter. That leaves 50 mosquitoes that will go inside the house. Of these 50 mosquitoes, 50 percent will be irritated and exit without biting. This leaves only 25 that will remain

indoors and bite. Of these 25 mosquitoes, 50 percent will absorb a toxic dose of DDT and die.

So, even if the separate actions of DDT function at only a 50 percent level of effectiveness, the combined impact will reduce the success of entering, biting and surviving by 88 to 89 percent, and roughly 86 percent of the total impact will be the result of repellent and irritant actions; only 14 percent of the impact will be due to DDT toxicity.

How does this relate to the real world of malaria and malaria control? Published works suggest that the level of effectiveness of separate actions of DDT residues will vary from one species of malaria vector to another. However, the repellent action alone is invariably *above the 50 percent level of effectiveness*. Field studies have shown that DDT residues repel 95 to 97 percent of major malaria mosquitoes in the Americas. Field experiments are often so overwhelmed by the repellent action that researchers cannot even measure the impact of irritant and toxic actions of DDT residues. . . .

#### How It Started

In 1975, the World Health Organization (WHO) and the United Nations Environment Program (UNEP) jointly announced that there should be greater emphasis on alternatives to the use of insecticides for vector-borne disease control. This joint announcement foreshadowed major changes in malaria control policies and strategies.

In 1979, the WHO announced a global strategy that de-emphasized vector control measures, and placed reliance on case detection and treatment as the preferred means of malaria control. That same year, the Director General of the WHO announced his desire to see malaria control programs moved into primary health care (PHC) systems.

In 1980, the UNEP, WHO, and others created the Panel of Experts for Environmental Management (PEEM) for vector-borne disease control.

Creation of the PEEM was followed by formal elimination of WHO's vector biology and control program. This was a major organizational change, because the vector biology and control program placed emphasis on use of insecticides for disease control. Elimination of WHO's vector biology and control program was also important in revealing a strategy of environmental advocacy groups to replace those who influenced policies with individuals who favored environmental protection over public health.

The final step in ideological revision of malaria control occurred in 1985, when the World Health Assembly adopted a resolution calling on participating countries to move malaria control into PHC systems.

Today, those changes in policies and strategies govern what is and what is not done to control burgeoning malaria rates. WHO's modern global malaria control strategy is based on case detection and treatment. . . . WHO's Roll Back Malaria initiative calls for use of insecticide treated nets. Insecticide spraying of house walls is not a part of the program.

---

**“Neither case detection and treatment, nor use of insecticide-treated nets will result in dramatic reductions of malaria.”**

---

Of course, in order to endorse insecticide-treated nets, it was necessary to change the yardstick for measuring effectiveness of malaria control methods. Decades past, DDT spraying was evaluated on the basis of total interdiction of malaria transmission. Today, use of nets is considered successful if there is reduction

in childhood death. The goal of the Roll Back Malaria initiative is to reduce the amount of malaria within treated populations.

Clearly there is a mismatch in the goal and methods of control. Neither case detection and treatment, nor use of insecticide-treated nets will result in dramatic reductions of malaria within treated populations.

#### Pressure to Phase Out DDT

International law specifically allows use of DDT for public health, and this is a victory for public health scientists around the world who campaigned vigorously for this option within the Stockholm Convention on Persistent Organic Pollutants (the “POPs Treaty”). Yet, in spite of this victory, the WHO, United Nations Environment Program (UNEP), United Nations International Childrens’ Emergency Fund (UNICEF), and the World Bank continue efforts to phase out public health use of DDT. It has become a common international practice to offer developing countries funds with the stipulation that they cannot be used to purchase or use DDT.

In 1997, the World Bank extended \$165 million in credit to India. The bank funds could be used for expensive pyrethroid insecticides, but none could be used for DDT. Similar pressures were tried in efforts to get the government of Madagascar to stop a successful program to control highland malaria by spraying house walls with DDT.

Perhaps the most egregious example of external pressures is with loans to Eritrea. Overall, 50 percent of mortality and 60 to 80 percent of morbidity in Eritrea is the result of malaria. Within the country there are 145 physicians and 391 nurses. In other words, there is a critical shortage of health profes-

sionals. The World Bank, jointly with UNICEF and U.S. Aid for International Development (USAID), provided assistance loans. The UNICEF funds were only for insecticide-treated nets. USAID funds were for environmental assess-

ment. The World Bank funds require Eritrea to “present by the end of the second year, a program and schedule for substituting DDT residual house-spraying by chemicals or techniques that are safer to the environment and human health.”

These examples provide clear and unambiguous illustrations of environmental advocacy trumping the public health policies of international organizations involved in malaria control.

In summation, without DDT, there is no real hope for reversing modern trends of increasing malaria (with the exception of control programs being restarted in urban areas). As malaria rates increase in developing countries, the risk of malaria being re-introduced to the United States and other developed countries will increase. WHO's global strategy for malaria control should be changed to emphasize more effective preventive measures. International pressure to stop public health uses of DDT should end.

---

**“International pressure to stop public health uses of DDT should end.”**

---

# 9,000-Year-Old Cities Beneath The Gulf of Cambay?

*Dated artifacts and sonar scans suggest the existence of two lost cities off the west coast of India, larger than Boston and twice as old as ancient Sumer.*

by Ramtanu Maitra

A senior Indian official reported on January 16, 2002, the discovery of submerged ruins at a depth of 40 meters in the Gulf of Cambay, off the coast of the State of Gujarat in northwestern India. The ruins are of two cities of vast extent, probably submerged by the sea level rise at the end of the last Ice Age, some 7,000 to 8,000 years ago. That makes these cities at least twice the age of ancient Sumer in Mesopotamia, which official archaeology has presumed to be the oldest civilization until now. Pieces of wood found in the underwater sites have been dated to between 8,500 to 9,500 years before the present.

India's National Institute of Ocean Technology (NIOT) made the Cambay discovery in 2001. The extreme tidal currents in Gulf of Cambay have so far prevented any attempt to capture underwater footage of the structures themselves. Instead, the ruins have been investigated through high-resolution sonar scans and through the recovery of about 2,000 artifacts from the site, including pottery, beads, broken pieces of sculpture, a fossilized jaw bone, and human teeth. Reports indicate that up to this point, divers have not been sent down. The available information is based on the sonar readings and the dredging done. Eventually, a way has to be found to get people down at the site to take a closer look at remains of the lost city, or lost cities.

## Two Cities

The sonar scans have so far revealed that the Gulf of Cambay actually holds two cities beneath its waters, both situated beside ancient river courses. One of the cities extends for at least 9 kilometers along the ancient riverbed, and at least



*Artifacts were found beneath the Gulf of Cambay in the state of Gujarat on the west coast of India.*

2 km away from it, giving a minimum surface area of 18 square km. The outer limits of the city have not yet been found, and further investigation may well reveal that the city is even larger than this. There are remains of a dam more than 600 meters long, across on one of the ancient river courses. The scans have also revealed that the cities consist of numerous rectangular buildings with foundations that were sturdy enough to survive thousands of years of pounding by the violent tidal currents. The NIOT has produced density analyses of the foundations compared with the silt between them, which suggest that the foundations are built of a uniform substance of great density—probably stone blocks.

Initially, archaeologists assumed that the site belonged to the Harappan Civilization, which flourished in northern India (part of which is Pakistan now) between around 5,000 and 3,000 years ago. However, it has been pointed out that geological models of sea-level rise strongly suggest the site is much older than that. Geologist Glenn Milne at the University of Durham

These objects were among thousands dredged up in the Gulf of Cambay in November 2001. The piece of wood (below) found among the artifacts was dated at two different laboratories to between 8,500 and 9,500 years before the present. At right (top) are four asymmetrical objects, each with a differently shaped central hole, one or two of which appear to have been squared off. The piece of wood shows what appear to be cut or tool marks on one side.

The object at right (bottom) shows a ridged or turned effect perhaps from some sort of lathe. There is a hollow passage through the middle, possibly drilled.



© Copyright 2002, Santha Faiia



© Copyright 2002, Santha Faiia



© Copyright 2002, Santha Faiia

believes that the site was probably submerged at the very end of the last Ice Age, between 7,700 and 6,900 years ago—pushing the date of the city well back into the prehistoric era. Milne's estimates were recently confirmed by radiocarbon dates achieved by two Indian laboratories from a piece of wood recovered from a shallow layer of the site. One laboratory dated the piece of wood to 6,500 B.C., and another dated it to 7,500 B.C. The NIOT hopes to obtain datable material from deeper layers of the site on a future expedition, and this may well push back the age of the submerged city even further.

#### Advanced Architecture

These dates, combined with the astonishing size and complexity of the city, effectively disprove the orthodox view of the origins of civilization, which holds that civilization first began with the Sumerians around 3,100 B.C. Even if the cultural background of the people remains unidentified, the lost city, if it is 9,500 years old, is older than the Sumerian civilization by several thousand years. It is older than the Egyptian, and even older than the Chinese civilization. So it would radically affect the overall picture of the development of urban civilization on this planet.

The submerged city of Cambay is at least 150 times larger than the largest Near Eastern settlements of 7,500 B.C., such as

the village of Catalhoyuk in Anatolia. In the 1920s, Sir John Marshall, who headed a team of explorers during the British rule in India, called the findings in Harappa and Mohenjo Daro the Indus civilization, because it flourished in the valley of the Indus River. Marshall's announcement pushed India's known history back by about 2,000 years. At the time of India's independence in 1947, barely a dozen Indus sites had been explored. With the prime sites, Mohenjo Daro and Harappa, becoming part of Pakistan, however, a feverish hunt began in India to locate and excavate Indus sites—a race that its neighbor soon joined. In doing so, they began uncovering a civilization so vast in its extent that at its peak it is estimated to have encompassed a staggering 1.5 million sq km—an area larger than Western Europe. In size, it dwarfed contemporary civilizations in the Nile Valley in Egypt and in the Tigris and Euphrates valleys in Sumer (modern Iraq). Its geographical boundaries are now believed to extend up to the Iranian border

on the west, Turkmenistan and Kashmir in the north, Delhi in the east, and the Godavari Valley in the south.

A recent count showed that as many as 1,400 Indus sites have been found, of which 917 are in India, 481 in Pakistan, and 1 in Afghanistan. While Mohenjo Daro and Harappa were regarded as principal cities, there were at least several others such as Rakhigarhi in the Indian state of Haryana, and Ganweriwala in Pakistan's Punjab province, that match them both in size and importance. It is also apparent that the civilization did not center only on the Indus Valley. When the sites were plotted on a map of the subcontinent, archaeologists noticed a curious clustering of sites along the Ghaggar River, which flows through the Indian states of Haryana and Rajasthan and runs almost parallel to the Indus. After entering Pakistan, where it is called Hakra, the river finally empties itself into the sea at the Rann of Kutch. More than 175 sites were found along the alluvial plains of the Ghaggar, as compared to 86 found in the Indus region.

What puzzled the archaeologists was that the Ghaggar-Hakra River and most of its tributaries are dry and their courses have silted up. So why did so many cities come up on such a desiccated water sheet, especially at a time when rivers were the lifelines of civilization? The answer to that puzzle is: unless, of course, at one time a mighty river flowed perennially along

that course. In their search for answers, Indus experts sought assistance of the *Rigveda*, the ancient Hindu text, which is believed to have been composed when the Indus Valley civilization was on the decline. Many of its hymns mention a sacred river called Saraswati, describing it as the foremost of rivers, big as the ocean, rising in the mountains and flowing between the rivers Yamuna and Sutlej before entering the sea. But in later Vedic hymn it is no longer described as mighty, which indicates that the Saraswati was already drying up.

### The Saraswati Mystery

In the 1980s, Indian satellite images of the region showed that the ancient bed of the Ghaggar-Hakra River could be traced from the Sivalik range of mountains in the Himalayas in the north to the Rann of Kutch. Where it is not covered by sand, the bed of the river consists of a fertile loam, and its width extends from 3 to 10 km on different parts of its course, making it a very large river. Putting together the evidence, V.N. Misra, director of the Department of Archaeology in the Deccan College, Pune, recently concluded that the Ghaggar-Hakra River was, in fact, the Vedic Saraswati and that it existed when the Indus civilization flourished.

It is held that the Ghaggar-Hakra River originated in the Himalayas and possibly in the area, which is known today as the Kashmir Valley, and that it used to flow through Punjab, Haryana, and western Rajasthan and pass through the Rann of Kutch in Gujarat. It is believed to have "disappeared" thousands of years ago as a result of unknown geotectonic changes. This is now being identified as the mysterious Saraswati River that went underground. According to India's Ministry of Culture, a committee of four experts is to undertake the task of "excavating" the Vedic river in the stretches between Adi-badri to Bhagwanpura in the Indian state of Haryana.

Saraswati was regarded as one of the mightiest and holiest rivers of its period, and the Vedas, ancient Hindu oral legends, are believed to have been composed on its banks. Over 1,200 of the 1,600 settlements, including many prosperous Harappan towns (3000 to 1500 B.C.) and ashrams of rishis (sages) existed along its banks, claims noted geologist K.S. Valdiya of the Jawaharlal Nehru Advanced Scientific Research Center. "Speculations abound about where the river met the sea. Some consider it to be the Gulf of Khambhat (Gulf of Cambay) passing through Lothal, Nal Sarovar, and the Great Rann of Kutch," says former deputy director of the Space Applications Center, Ahmedabad, Dr Baldev Sahai, who chairs the Saraswati Nadi Shodh Abhiyaan and will head the Haryana committee. He says that although scientific evidence of Saraswati needs to

be established, if the palaeodrainage (buried course) of Saraswati is found, there will be very high chances of finding ground water.

In their study on "Ancient ports of Gujarat," deputy director A.R. Dasgupta and scientist P.S. Thakker of the Space Applications Center, and former director of Archaeology M.H. Raval have collated information on the flow of river Saraswati in Gujarat. According to them, "it is reported that Saraswati flowed along the bank of the Little Rann of Kutch and poured its water into the Gulf of Khambhat (Gulf of Cambay), till 325 B.C."

Recent satellite images of the Great Rann of Kutch, which according to scientists was submerged for more than 1,000 years, also show signs of a mighty river flowing in this area. The flow of the river, which is north to south in direction and has a bifurcation, is located between 70° 15' to 70° 30' East. Scientists found a major opportunity after the January 2001 earthquake, during which water was found flowing in many channels in the Rann. Scientists at the Physical Research Laboratory in Ahmedabad tested one such water sample, collected from Narveri near Khavda in Kutch, using the Helium-Radon Method. They determined the age of the water to be between 12,000 and 89,000 years old. However, in the absence of interest and efforts for search of a lost river, waters of Saraswati still believed to be flowing under the terra firma of Gujarat, will remain inaccessible.

How did this mini-acropolis slide into the Gulf of Cambay to be forgotten by history? Theories abound. One of the more mainstream theories avers that a couple of major rivers may have been flowing approximately in the east-west direction coinciding with the course of the present day Tapti and Narmada rivers. Because of geological and tectonic events, the entire Cambay area might have sunk—taking down with it the westernmost section of the then existing river and the habitation settled along its banks. On the other hand, the NIOT team, supported by the Department of Ocean Development secretary Harsh Gupta, an expert seismologist, puts forward



© Copyright 2002, Santha Faiia

*A group of three dive boats used in the expedition are launched into the Gulf at Mahabalipuram.*

# The Concept of Indo-European Philology

A philological project, first proposed by Gottfried Leibniz and realized a century later in the German classical renaissance of the late 18th Century, identified a great variety of living and dead languages as part of the Sanscritic or Indo-Germanic (now known as the Indo-European) language group. Ancient and modern Persian, Russian and the Slavic languages, the Germanic languages, the Romance languages (including Italian, Spanish, and French), Celtic and Gaelic, and ancient Greek and Latin were among the included languages.

The studies showed that the differences among the languages could be explained if one assumed that certain lawful transformations of both consonant and vowel sounds had taken place as speakers of a once-common language became separated from each other over time. By comparing the wide range of languages, philologists, some of whom were fluent in dozens of languages, were ultimately able to reconstruct a hypothetical original language, now usually called Proto Indo-European. Beginning from this hypothesized original language, it could be shown how a great number of the words found in existing and known ancient languages of the Indo-European group had derived through a lawful process of consonant and vowel shift (see chart).

The studies also looked into a deeper level of the conceptual, grammatical and structural content of languages. Certain common patterns, such as the inflection of verbs (that is the changing of the endings of verbs to denote the person speaking), the means of forming tenses, and many other features were found to prevail across this whole widespread group of languages. In general in Indo-European languages, verbs are formed from a root having a meaning that denotes some type of physical transformation, combined with a preposition denoting a geometrical direction (as in-out, up-down, over-under, and so forth).

Plato in the *Cratylus* dialogue suggested that the origin of many verbs was in the sound made by the action being described, and provided many humorous examples, some of which are recognizable in English translation because of the large number of cognate words (glide and gloss are examples).

But here a problem arises. To create a verb that describes some non-empirical operation, such as the thought process, one must find some other means of expression, as Plato also notes in his dialogue—and with much humor at the expense of the strict, sense-certainty advocates of his day. The solution lies in metaphor. Take the verb *to hypothesize*. It comes from a Greek root meaning *to set down*, and the preposition *hypo-* meaning *under*. What does *setting down* have to do with thinking? Of course, nothing, literally. Yet we *set down* ideas in English all the time; or set down the rules of the game, and so forth.

With a little thought one can see how *under* comes in. In English to *set down under* does not mean to hypothesize, but the concept of what is underneath something that is set down,

the underpinning of an idea, for example, gets at the meaning of hypothesize. Perhaps an English example would be better. Unfortunately our philosophical terminology is rife with Greek and Latin terms, for various historical reasons. But take the verb *to undertake*. The meaning of that English verb is a metaphor, precisely of the Indo-European type, with a root verb and a geometrical preposition. The literal mind would have difficulty explaining what it means to *undertake* something, or to engage in a great *undertaking*, from the strict meaning of the two parts of the verb. Even the fellow in the funeral parlor does not literally *undertake*, for that is the job of the sexton and the pallbearers.

But one should not take individual words too seriously, lest one contract the disease known as semanticism, or linguistics. For one thing, no one speaks words. As anyone who has tried to learn a new language as an adult comes to learn, what actually comes out of the mouth are run-together things. Trying to decipher a foreign tongue from the word lists memorized from a language text can be quite frustrating—or amusing, if one has the right approach.

On a yet deeper level, the poetic conveyance of meaning through metaphor as expressed in myths and fairy tales, and the interplay of music and language through poetry was revealed by this great philological project. The Brothers Grimm, who are best known today for their fairytale collections, were prominent members of a group of early 19th Century Indo-European philologists working in Germany.

## SOME EXAMPLES OF CONSONANT SHIFT AMONG INDO-EUROPEAN LANGUAGES

<i>p to f</i>		
Greek	German	English
pente	funf	five
pisces	Fisch	fish
pleres	voll	full
pod-	Fuss	foot
[Latin]		
porro	fern	far
<i>c to h</i>		
Latin	German	English
centum	hundert	hundred
canis	Hund	hound
cordis	Herz	heart
caput	Kopf	head
que	wie	how

*The transformations occur not from Latin or ancient Greek to what we consider the more modern languages, but from a common original language that is no longer spoken but must be hypothesized.*



Others included Philipp August Boeckh and Franz Bopp, who carried out great pioneering work in Indo-European philology, which study they considered, not as a narrow "linguistics," but the mastery of ancient culture as a totality. Unfortunately, their work has never been translated into English. A key coordinator of the philology project was Wilhelm von Humboldt, whose great study of the Kawi language (partial translation available in English under the title *On Language*) gives an idea of the philosophical and methodological depth required in probing this greatest of all human inventions.

### The Oral Tradition

Respecting the poetic content, certain styles of versification can be found to prevail over a wide variety of the Indo-European language groups. From a very early time, epic verses were composed and sung to music, which aided both the presentation of the concepts and the memorization. Where people lived without writing, or without a means of preserving written records, the verses were the means of preserving history. But even so, the greater power of speech over writing in conveying meaning weighed and still weighs in its favor. Combining speech with music proved the most powerful of all means of preserving and conveying profound ideas, such as the concept of God and of man's relationship to the universe. Thus we find a form of sung verse in every religion, a phenomenon which spreads far beyond the speakers of Indo-European tongues.

From notions of God to scientific notions of the universe is not nearly so far as modern skepticism has tried to argue. Scientific records were thus kept in the form of sung verse. The Indian scholar Bal Gandaghar Tilak showed, for example, that complex astronomical events, such as the times of the solstice and equinox, and the secular change in the heliacal rising of the Sun against the star background, were preserved in the form of stories in the ancient Vedic texts. The Greek myths concerning star formations are also suggestive of the same, as is the fact that the same constellations were recognized across a wide variety of cultures.

Classical philology scarcely exists any longer in university departments, having been replaced by a narrowly defined historical linguistics and other straitened doctrines. The original concept of philology is almost unknown today. It was already under attack by British Empire operations in the 19th Century, which attempted to appropriate the findings of philology to justify doctrines of Anglo-Saxon and so-called Aryan racial superiority. Unfortunately, the charge of "Eurocentrism" levelled against classical philology is accepted by even some of the better-inclined modern philologists. One finds such acceptance in the work of Joseph Greenberg's collaborator, Merrit Ruhlen, (*The Origin of Language: Tracing the Evolution of the Mother Tongue*, 1994) who otherwise makes a bold effort to carry Leibniz's hope for discovery of the original language further back in time, seeking relationships among all the languages of Eurasia, of Africa, and elsewhere.

—Laurence Hecht

the earthquake theory to explain the disappearance of this town by the river.

In the wake of the catastrophe in the massive earthquake in the state of Gujarat in January 2000, no one will argue with the fact that western India has tectonically been an active terrain from the pre-Cambrian era to the present day. What is even more interesting is that the beginning of history will itself have to be pushed back at least 4,000 years, because the Cambay cities have already yielded evidence of writing. A piece of stone has been recovered with an unknown script engraved on it in a circular pattern. Some of the characters in the script look rather similar to characters in the Harappan script, which appeared 4,000 later, and which still remains undeciphered. It is evident that additional research is to be undertaken to identify the culture of the people who lived in that city that is now under water.

Applying his expertise in physical economy, *21st Century* Scientific Advisory Board member Lyndon H. LaRouche, Jr., has pointed to the submerged continental shelves as the places where the remains of ancient, maritime civilizations would be found, and has, since 1982, insisted that the cities of coastal maritime civilizations must predate the so-called riparian civilizations long claimed by archaeology to be the oldest. "For example, the case of Sumer," LaRouche wrote in November 2001,

as emphasized by the account of the historian Herodotus . . . we are informed that the Phoenicians, ancient Sheba, ancient Abyssinia, and Sumer, were among the colonies founded by a maritime culture which ostensibly dominated the relevant regions of the Indian Ocean. . . . The sundry archaeological fragments show a relatively powerful such maritime culture of broadly Dravidian language-pedigree during that interval, a language which interacted with the Aryans' Vedic. To situate these developments, including the Aryan descent upon South Asia, we must take into account the most catastrophic phases of the post-17th millennium (B.C.) glacial melt, and the succession of climate changes, especially from about 10,000 B.C. onward.

Underwater formations, suggestive of the remains of ancient cities or megalithic structures, have been detected on the continental shelves off China, Japan, southeastern India, and Cuba in the past two years. But these have not yet yielded datings, as has the very ancient city under the Gulf of Cambay.

The ancient Vedic texts, which are at the heart of Hindu philosophy and religion, already tell us of an early civilization of great sophistication that was submerged beneath the sea at the end of the last Ice Age. Plato, writing in *Critias* and *Timaeus* around 300 B.C., described the submergence of a mythical city, which was already dated back some 9,000 years by raconteurs in his day. Plato's words could well be describing the "mysterious acropolis" dredged up from the depths of the Gulf of Cambay, just a few months ago. Replace "Atlantis" by "Cambay," and we go back to an urban civilization dating anywhere between 4000 and 6000 B.C.

---

*Ramtanu Maitra, trained as a nuclear engineer, is head of the New Delhi bureau of Executive Intelligence Review magazine, and a member of the 21st Century Scientific Advisory Board.*

# Gauss and Weber's Creation of The Absolute System of Units In Physics

by Andre Koch Torres Assis, Karin Reich, and  
Karl Heinrich Wiederkehr

*A specialist in Weber's electrodynamics, and leading biographers of Weber and Gauss, tell how Gauss's 1832 work in magnetism changed physics, and led to Wilhelm Weber's development of the laws of electricity.*



Museum of the City of Göttingen

*Wilhelm Weber (1804-1891). Physics professor in Göttingen from 1831; expelled by the King Ernst Augustus in 1837.*

**H**ere we discuss the work of Carl Friedrich Gauss (1777-1855) in magnetism, centering our analysis in his work of 1832 and its consequences for physics.<sup>1</sup> We also analyze the extension of this line of research accomplished by Gauss's collaborator Wilhelm Eduard Weber (1804-1891).<sup>2</sup>

Electricity and magnetism had become very active fields by the 1830s, when Gauss turned his full attention to them. The science of Earth magnetism, which until then had been isolated from other fields, suddenly became a center of attention when the close connection between magnetism and the science of electricity was discovered. Hans Christian Oersted had discovered electromagnetism in 1819; Thomas Johann Seebeck discovered thermoelectricity in 1821; A.M. Ampère developed in the 1820s his famous work of the interaction between current elements; and Michael Faraday described electromagnetic induction in 1831. Ampère interpreted all magnetic phenomena as the interaction between currents, and hypothesized the existence of micro-currents within the particles of magnetized

**EDITOR'S NOTE:** *Although we disagree with the Newtonian standpoint of our friend Dr. Assis, we print the following in furtherance of a dialogue on the subject, and its important implications for understanding the Ampère-Gauss-Weber electrodynamics.*

bodies. A "terrestrial current" flowing over the surface of the Earth from east to west, according to Ampère, would force a magnetic compass needle to its orientation.

Beyond this general interest in the themes of magnetism and electromagnetism, there were two key factors which motivated Gauss to initiate his real work in this field: the direct influence of Alexander von Humboldt (1769-1859) and that of his collaborator, Wilhelm Weber, who filled the vacant chair of physics in Göttingen in 1831. Humboldt had already created a European network of regular, synchronous magnetic observations (Ref. 8). In a letter to Weber from Paris at the end of 1831, Humboldt expressed the wish that Göttingen could also participate in the simultaneous observations (Ref. 9). The meaning of this letter was recognized and first quoted by K.H. Wiederkehr (Ref. 10).

In 1828, Humboldt organized and presided over the Meeting of the German Association of Natural Scientists and Doctors, which took place in Berlin. Gauss was his personal guest in this Conference. Weber also took part, and it was here that he met Gauss for the first time (see Ref. 2, p. 32). Three years later, Weber was nominated to the chair of physics at Göttingen University, based on an expert judgment written by Gauss (Ref. 11). At this time Gauss was 54 years old and Weber 27. Gauss could then realize his project with the help

INTENSITAS  
VIS MAGNETICAE TERRESTRIS

AD MENSURAM ABSOLUTAM REVOCATA.

COMMENTATIO

AUCTORE

CAROLO FRIDERICO GAUSS

IN CONSESSU SOCIETATIS MDCCCXXXII. DEC. XV. RECITATA.

---

Commentationes societatis regiae scientiarum Gottingensis recentiores. Vol. VIII.  
Gottingae MDCCCXXXI.

---

Cover page of Gauss's famous work "The Intensity of the Earth's Magnetic Force Reduced to Absolute Measurement" (1832), in which the absolute system of measurements (triple system) was founded.



Museum of the City of Göttingen

Carl Friedrich Gauss (1777-1855). Among the greatest mathematicians of all time, he also carried out pioneering research in astronomy, surveying, and experimental physics.

from Wilhelm Weber, an already experienced and ingenious experimental physicist. The wisdom of the older was thus connected with the energy of the younger.

### Gauss's Seminal Paper

We now turn to the first fruit of Gauss's work in magnetism.

On December 15, 1832, Gauss read his famous treatise, *Intensitas vis magneticae terrestres ad mensuram absolutam revocata* (The intensity of the Earth's magnetic force reduced to absolute measurement), before the meeting of the Göttingen Scientific Society. As Gauss states in this treatise, he was assisted by Wilhelm Weber in many ways in undertaking this work. The original article in Latin was published in 1841 and is reprinted in Gauss's Collected Works (Ref. 12). There are two different German translations, one of 1833 and one of 1894 (Refs. 13, 14). In the published German version of 1833 it is not stated who was the translator. But we know that it was J.C. Poggendorf, the editor of the *Annalen der Physik und Chemie*, as this was stated by Gauss in a letter to H.C. Schumacher in 1845 (see Ref. 15, pp. 436-440). In this letter, Gauss also stated that he considered it a bad translation. There are also other translations: French (1834), Italian (1838), Russian (1952) and an unpublished English translation (see Refs. 16, p. 35; 17; and 18, Note).

In order to explain magnetic phenomena, Gauss assumes in

the *Intensity* the existence of two magnetic fluids (north/positive and south/negative), following the ideas of Coulomb and Poisson (see Ref. 19, pp. 57-65). According to Gauss, these fluids are associated with the ponderable particles of the body where they are located, attracting (opposite signs) or repelling (same sign) one another according to the inverse square of the distance. Only in the last section of the *Intensity* does Gauss mention the possibility of explaining magnetism by assuming the existence of electric currents around the particles of the magnetic body. This last idea is that of Ampère (see Ref. 20, with partial English translation in Ref. 21), although Gauss does not mention his name.<sup>3</sup>

There are two main aspects of this work which made it epoch-making. The first is the reduction of magnetic magnitudes to mechanical ones, the so-called absolute system of units introduced here by Gauss. The second is the effective measurement of the magnetic properties of the Earth and of a magnetized needle with an accuracy until then unattainable. The term "absolute measurement" in the title is here in opposition to "relative measurement." In his travels through America and Russia, Alexander von Humboldt had performed regular magnetic measurements, determining the Earth's magnetic intensity by counting the oscillations of a bar magnet (magnetized needle). Humboldt assumed the constancy of the

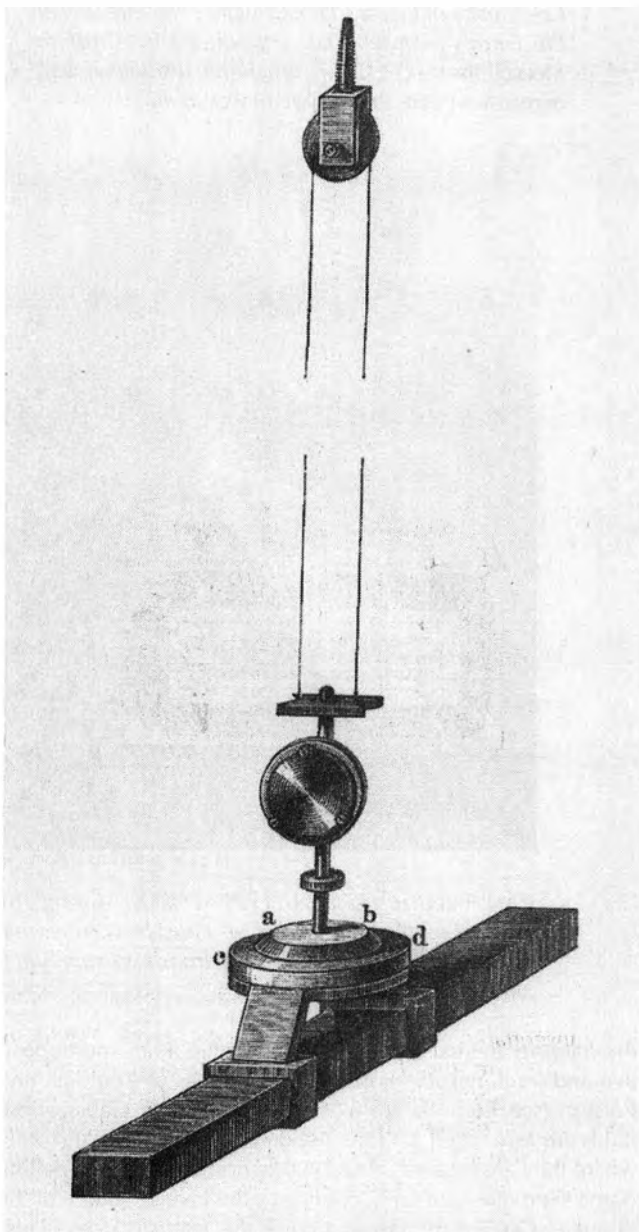

Gustav Wiedemann, *Die Lehre von der Elektrizität*, Vol. 3 (1894), p. 344

A great bar magnet weighing several kilograms from one of Gauss's magnetometers, shown here with bifilar suspension and mirror. The mirror reflected the image of a meter stick mounted atop a telescope placed a few meters away. By this means, the angle of deflection of the magnet could be determined with astronomical accuracy.

magnetic moment of the needle. This magnetic moment  $\vec{M}$  is the product of the distance between the poles of an (ideal) magnet by the magnetic fluid in the positive pole. The magnetic fluid corresponds to the "free magnetism." The direction of  $\vec{M}$  is along the axis of the bar magnet pointing from the negative pole to the positive one. The period of oscillation of a magnet is proportional to the square root of the intensity of the magnetic field acting on the bar.<sup>4</sup>

Humboldt determined that the intensity of the Earth's mag-

netic field increased from the magnetic equator toward the magnetic poles. He compared all intensities with the intensity of the magnetic field at the magnetic equator, which he assumed to have intensity equal to 1 (see Ref. 10). In his measurements it was assumed that the magnetic force of the bar (its magnetic moment) was constant, which is not at all certain. This magnetic moment of the needle, the magnetic field where it was oscillating (for Humboldt and Gauss it was the Earth's magnetic field), or both of them, can change with time. In order to make exact comparisons of the magnetic field of the Earth at one location at different periods of time separated by a great time interval, another method is necessary.

### Gauss's Solution

The period of small oscillations of a magnetized needle around an axis orthogonal to a constant and uniform magnetic field  $H$  is given by  $2\pi \sqrt{I/MH}$ , where  $M = |\vec{M}|$  and  $I$  is the moment of inertia of the needle (see Ref. 27, p. 19). By measuring this period of oscillation and the moment of inertia of the needle oscillating under the influence of the Earth's magnetic field  $H$ , it is possible to obtain the product  $MH$ . In order to obtain  $M$  and  $H$  separately, one must also measure their ratio  $H/M$ . This can be done using a second needle as an auxiliary, which is exposed both to the influence of the Earth's magnetism and of the first needle. In the first case, one isolates the effect on the second needle of the Earth's magnetic field. In the second case, one measures the effect on the second needle of the combined influence of the Earth's magnetic field and the magnetic field of the first needle, which is proportional to its magnetic moment. By combining these two cases it is then possible to ascertain the ratio  $H/M$ . With the previously measured value of  $MH$ , it is then possible to obtain separately the values of  $M$  and  $H$ , as desired (Figure 1).

In the seventh paragraph of the *Intensity*, Gauss describes two methods for measuring the effects of the Earth's magnetism (with and without the presence of the first needle) on the second auxiliary needle. The first method, which had been proposed by Poisson in 1828, is to observe the oscillation of the second needle (Ref. 27, pp. 23-27). However, Gauss does not employ this method in the *Intensity*, because of the inaccurate results which it had so far produced. Instead, he proposes and carries out measurements by a second method, which he developed independently of Poisson, consisting in observing the second auxiliary needle in states of equilibrium. Gauss described it as follows:

In the second method, the first needle is placed so that the direction of the force, which it exerts on the location of the second, freely suspended, needle, forms an angle (for example, a right angle) with the magnetic meridian; by this means the second needle itself will be deflected out of the magnetic meridian, and from the magnitude of the deviation, one can infer the relation between the terrestrial magnetic force and the influence of the first needle [Ref. 17].

By the application of this second method, Gauss determined with high precision, both the Earth's magnetic field strength and the magnetic moment of the needle which he had used. A good

description of his procedure can be found in Ref. 27, pp. 17-23.

We now want to emphasize a very important and new aspect introduced by Gauss in this work. In the *Principia* (1687), Newton introduced the law of gravitation in terms of proportionalities (see Ref. 28, Book I, Props. 72 to 76; Book III, Props. 7, 8; and General Scholium; and Ref. 29, pp. 20-21). In particular, he showed that the gravitational force between two bodies is proportional to the product of their masses and inversely proportional to the inverse square of their distance. Coulomb in 1785 arrived at the fundamental laws of electrostatics and magnetostatics also expressing himself in terms of proportionalities (see Refs. 30, 31; and 29, pp. 244-245). Coulomb assumed the magnetic attractions and repulsions to be proportional to the densities of the magnetic fluids, and demonstrated experimentally that they are inversely proportional to the square of their distance of separation.

By the beginning of the 19th Century, scientists were expressing these laws in terms of equalities. To this end, they introduced proportionality factors (constants) into the laws of gravitation, electrostatics, and magnetostatics, which depended on the system of units employed. Poisson (1825), for instance, wrote the magnetic force  $F$  between two magnetic fluids,  $m_1$  and  $m_2$ , separated by a distance  $r$  as  $F = fm_1m_2/r^2$  (for discussion, see Refs. 27; pp. 11-12 and 23-25). Gauss was the first to specify the value  $f = 1$  dimensionless to this proportionality factor in his work *Intensity*. This appears in the first section of this work, which merits quoting here in full:

To explain magnetic phenomena, we assume two magnetic fluids: one we call north, the other south. We presuppose, that the elements of the one fluid attract those of the other, and that on the other hand, two elements of the same fluid mutually repel each other, and that each of the two effects alters in inverse relation to the square of the distance. It will be shown below that the correctness of this law was itself confirmed by our observations.

These fluids do not occur independently, but only in association with the ponderable particles of such bodies which take on magnetism, and their effects express themselves either when they put the bodies into motion or they prevent or transform the motion, which other forces acting on these bodies, e.g. the force of gravity, would elicit.

Hence the effect of a given amount of magnetic fluid on a given amount of either the same or the opposite fluid at a given distance is comparable to a given motive force, i.e. with the effect of a given accelerating force on a given mass, and since the magnetic fluids themselves can be known only through the effects, which they bring forth, the latter must directly serve to measure the former.

In order, however, that we may be able to reduce this measurement to definite concepts, units must above all be established for three kinds of magnitudes, namely, the unit of distance, the unit of ponderable mass, and the unit of acceleration. For the third, the gravity at the locus of observation can be assumed: if, however, this is not suitable, the unit of time must also enter in, and for us that acceleration will be  $= 1$ , which, within the time unit, produces a change of velocity of the body in the direction of its motion, which is equivalent to the unit.

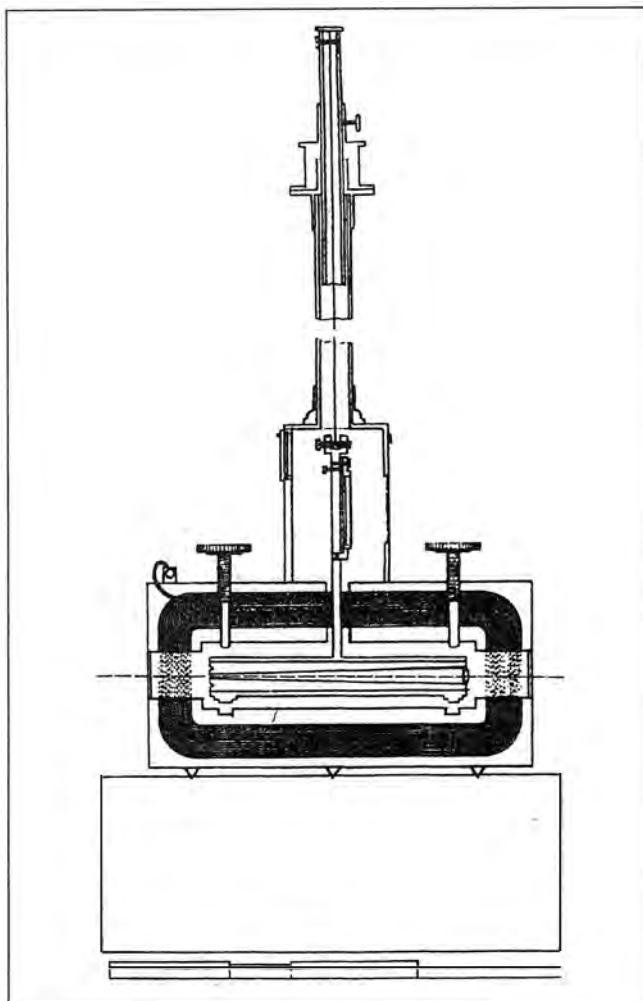

From Wilhelm Weber's *Werke*, Vol. 2, p. 89 (plate VI, between pp. 118 and 119)

*The transportable magnetometer of Wilhelm Weber (1838). A suspension wire runs down the upper tube to a vertical rod holding the mirror (shown in profile). At the bottom, the rod connects to a magnet. This handy instrument served a double purpose. Aside from making magnetic measurements, the coil surrounding the magnet permitted galvanic measurements.*

Correspondingly, the unit of the amount of north fluid will be that whose repulsive effect on another like it, and whose existing amount of motive force in the unit of distance  $= 1$ , i.e. the effect of an accelerating force  $= 1$  on a mass  $= 1$ ; the same will be true of a unit of the amount of south fluid; in this definition, clearly the active fluid, as well as that of the effect, must be thought of as, at bottom, united in physical points. Beyond this, however, it must be assumed, that the attraction between given quantities of different kinds of fluids at a given distance is equal to the repulsion between the same respective quantities of the same kind of fluid. Hence the effect of a quantity  $m$  of north magnetic fluid on a quantity  $m'$  of the same fluid at distance  $r$  (each of the two fluids being assumed to be united as at one point) will be expressed as  $mm'/rr$ ; or it is equivalent to a motive force  $= mm'/rr$ , which acts in the direction of

the first against the second fluid, and evidently this formula holds true in general, when, as from now on we wish to stipulate, a quantity of southern fluid will be considered as negative, and a negative value of the force will signify attraction. Hence if equal quantities of north and south fluid are found simultaneously at one physical point, no effect at all will arise; if, however, the amounts are unequal, only the remainder of the one which we wish to term free magnetism (positive or negative) will come under consideration [Ref. 17].

In analytical mechanics it was already common to express all magnitudes based on the three basic units of length, mass and time; for Gauss these were the millimeter, (mm), the milligram, (mg), and the second, (s). For example, a unit force was that which acting on a constant unit mass generated a unit acceleration. Based on Coulomb's law, which described the interaction between magnetic poles, Gauss extended these

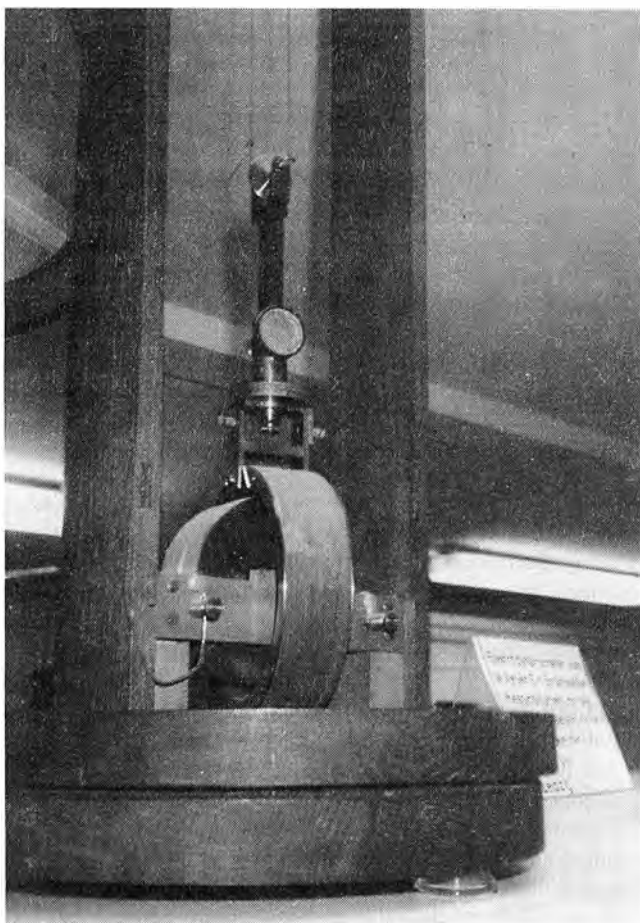

Laurence Hecht

*The electro-dynamometer used by Wilhelm Weber to prove the validity of Ampère's fundamental law for closed currents. It consisted of a rotatable coil, and a second coil which fit inside the rotatable one (as shown) but could also be placed in other positions outside it. The rotatable coil has a bifilar suspension and mirror. The electro-dynamometer could also perform measurements of alternating currents. The device is preserved in the museum of the Physical Institute at Göttingen.*

three basic units to the realm of magnetism.

In essence, Gauss was able to define and measure with great precision the magnetic moment of a magnetized needle and the intensity of the Earth's magnetic field, using only the units of distance, mass, and time. The core of Gauss's expression of magnetic magnitudes based on mechanical ones lies in his operational definition that a unit of magnetic pole is that quantity which generates a unit force when acting on an equal unit magnetic pole separated from the first by a unit distance.

Gauss also defined a unit intensity of the magnetic force (or a unit magnetic field as we would say today), as the intensity which acting on a unit pole generates a unit force. In Section 26 of the *Intensity*, for instance, he wrote down the basic equation describing the interaction between magnetic poles as:  $mm/r^2 = w = pa$ , where  $m$  is the number describing the quantity of magnetic fluid acting on another equal quantity separated by a distance  $r$  and exerting a force  $w$  (which he equated to  $pa$ , and where  $p$  is the constant mass of the body experiencing the force and  $a$  its acceleration).

As there are no isolated magnetic poles in nature, the following equivalent definition was also frequently employed: there is a unit intensity of magnetic field when a magnet with a unit of magnetic moment is acted upon by a torque (turning moment) of intensity 1, caused by this supposed constant and uniform magnetic field acting orthogonal to the magnetic axis of the magnet. In this way, it was not necessary to introduce a specific dimension describing a magnetic pole.

Another advantage of Gauss's proposal is that many physical laws take a very simple form, without arbitrary universal constants (such as  $\epsilon_0$  and  $\mu_0$  used in the International System of Units, MKSA, for example). Later, this triple-system of units was called an absolute system of measurement. The triple-system has proven its utility over a long time. Despite some variation, the International System of Units is based essentially on the absolute electromagnetic system of units introduced by Gauss and Wilhelm Weber

### Gauss and Weber

Wilhelm Weber absorbed these ideas of Gauss completely and turned them into reality with his life's work. In the joint research in electricity and magnetism, which the two carried out from 1831 onward, it is sometimes difficult to distinguish the contributions of one from the other. Weber followed the procedures of Gauss in the electromagnetic system of units and measurements which he created. In an article of 1840, published in 1841, Weber introduced the first definition of the absolute electromagnetic unit of current making use of the magnetic effect of a closed current acting on a magnetized needle (Ref. 32). A more precise definition was given in 1842 (Ref. 33). A current with one electromagnetic unit will be the current which flowing in a circuit of plane area 1 exerts the same effect as a magnet with magnetic moment equal to 1. Another statement of this definition he presented in 1851:

As an absolute unit of intensity, can be understood the intensity of that current which, when it circulates through a plane of the magnitude of the unit of measure, exercises, according to electro-magnetic laws, the same action at a distance as a bar-magnet which contains the



Museum of the City of Göttingen

*Wilhelm Weber around 1855 at the time of the famous experiment with Kohlrausch.*

unit of measure of bar magnetism [Ref. 34 with English translation in Ref. 35].

Maxwell expressed this as follows:

It has been shown by numerous experiments, of which the earliest are those of Ampère, and the most accurate those of Weber, that the magnetic action of a small plane circuit at distances which are great compared with the dimensions of the circuit is the same as that of a magnet whose axis is normal to the plane of the circuit, and whose magnetic moment is equal to the area of the circuit multiplied by the strength of the current [Ref. 36, Art. 482, p. 141].

In 1851 and 1852, Weber introduced the absolute electromagnetic units of electromotive force (tension) and of resistance (Refs. 34, 35, 36). For the absolute measure of electromotive force in electromagnetic units, he defined:

[T]hat electromotive force which the unit of measure of the Earth's magnetism exerts upon a closed conductor, if the latter is so turned that the area of its projection on a plane normal to the direction of the Earth's magnetism increases or decreases during the unit of time by the unit of surface [Ref. 35].

For the absolute measure of resistance in electromagnetic units, he utilized Ohm's law (1826). The definition runs as follows:

[T]hat resistance can be taken as unit of measure,



Museum of the City of Göttingen

*Rudolf Kohlrausch (1809-1858), one of the leading physicists for electrostatic measurements in this period.*

which a closed conductor possesses in which the unit of measure of electromotive force produces the unit of measure of [electric current] intensity. (Ref. 35).

Weber also developed special methods for the determination of electric resistance which were employed for many years.

In 1846, Weber introduced the electrodynamic unit of current by means of Ampère's force between current elements; see Refs. 38 and 39 with English translation in Ref. 40, which is  $1/\sqrt{2}$  times the absolute electromagnetic unit. And this is the origin of the factor 2 which appears in the definition of the unit of current (called ampère) in the International System of Units.

By analogy with what Gauss had done for magnetostatics, Weber defined the electrostatic unit of charge by means of the electrostatic force between two charges, expressed with coefficient 1 unitless, expressing this force as  $ee'/r^2$ , where  $e$  and  $e'$  are the point charges separated by the distance  $r$  (Refs. 41-43):

The unit of electrical fluid is determined in electrostatics by means of the force with which the free electricities act on each other at a distance. If one imagines two equal amounts of electricity of the same kind concentrated at two points, whose distance is the unit of length, and if the force with which they act on each other repulsively, is equal to the unit of force, then the amount of electricity found in each of the two points is the measure or the unit of free electricity [Ref. 42].

By supposing the galvanic currents to be the result of the motion of charges, Weber was able to make a definition of current intensity related to the amount of charges flowing over the cross-section of the circuit. It should be observed that Weber

assumed the Fechnerian hypothesis of a double current in a conductor (positive and negative charges moving with equal and opposite velocities relative to the wire). His mechanical measure of current intensity is not identical with the absolute electrostatic measure of current intensity, in which one unit of electrostatic charge flows in one second over the cross-section of a conductor. In the unit of current intensity in Weber's mechanical measure, a positive and also a negative electrostatic unit of charge flows through the cross-section:

This measure, which will be called the mechanical measure of current intensity, thus sets as the unit, the intensity of those currents which arise when, in the unit of time, the unit of free positive electricity flows in the one direction, an equal amount of negative electricity in the opposite direction, through that cross-section of the circuit [Ref. 42].

The unit of current intensity according to Weber's mechanical measure is thus twice as great as the unit of the current intensity in the absolute electrostatic system of measure. For this reason, Weber and Kohlrausch, by forming the quotient of the measured electrostatic and electromagnetic charges, obtained only (approximately) half the value of the velocity of light in vacuum, in their famous 1855 experiment (Refs. 44 and 41, with English translation in Refs. 42 and 45).

In order to arrive at the electrostatic charge, one must multiply by 2 the value of the flowing "mechanical" electrical charge which produces the magnetic field acting upon the small magnet in the tangent galvanometer (from which the intensity of the current in electromagnetic units is determined). G. Kirchhoff, B. Riemann, and J. C. Maxwell interpreted the quotient as the light velocity in vacuum. For Maxwell, the outcome of the 1855 experiment by Kohlrausch and Weber was the main basis for his electromagnetic theory of light of 1861 (see Refs. 6; 46; 25, Sect. 3.1; and 47).

Although Gauss published only his operational definition of magnetic fluid and intensity of the magnetic force (known today as magnetic field strength), he arrived, around 1835, at other essential results, as is evident from his posthumous works published in 1867 (see Ref. 48 pp. 630 and 637; Ref. 2, pp. 121 and 213; and Ref. 27, pp. 115-118). By combining Newton's second law of motion with his universal law of gravitation, assuming proportionality factors equal to 1 dimensionless, Gauss showed that the dimensions of the unit of mass are given by  $mm^3s^{-2}$ , which is the so-called astronomical system of measurement. By utilizing Biot-Savart's law

for the magnetic field of a current-carrying wire and adopting a dimensionless proportionality factor equal to 1, he arrived at the dimension of an electric current as  $mm^{1/2}mg^{1/2}s^{-1}$ . Later on, Weber greatly extended and developed these approaches.

### The Magnetic Association

Gauss and Weber became a crucial part of the Humboldtian observational network. From this, resulted the Magnetic Association of Göttingen (Göttinger Magnetische Verein) (Refs. 10; 2, pp. 45 and 53; and 49). This association was the model for later international cooperation in the First Polar Year (1882-1883) and the International Geophysical Year (1957-1958) (Ref. 50). Gauss and Weber created a yearly publication for this Association, known as the "Resultate aus den Beobachtungen des Magnetischen Verein" (Results of the Observations Made by the Magnetic Association), in which the joint observations were collected and analyzed, and new appointment dates were made known. Six yearly volumes from 1836 until 1841 and an Atlas of Terrestrial Magnetism were published. These also contained instructions for the construction and use of instruments for the new magnetic observatories being erected. Such well-known works of Gauss as the "Allgemeine Theorie des Erdmagnetismus" of 1838 (General theory of terrestrial magnetism), and "Allgemeine Lehrsätze in Beziehung auf die im verkehrten Verhältnis des Quadrats der Entfernung wirkenden Anziehungs- und Abstossungskräfte" of 1839 (General propositions relating to attractive and repulsive forces acting in the inverse ratio of the square of the distance) first appeared in the *Resultate*. And in the

annual volume for 1840, Weber first set down the absolute measure of the current intensity according to electromagnetic units.

The cooperation between Gauss and Weber which produced such beautiful results ended suddenly in 1837, with the *coup d'état* of the King of Hannover Ernst-August. Wilhelm Weber was one of the Göttingen Seven, the seven professors who protested against the arbitrariness of the monarch, and had to pay for their courageous action by dismissal from their university positions. Because of financial support from citizens with democratic-patriotic views, Weber was able to stay for some more years in proximity with Gauss, to remain active in the Magnetic Association of Göttingen, and to bring the work already begun to its conclusion. During his trip to England in 1838, Wilhelm Weber was able to meet John Herschel (son of William Herschel) and to convince him of the importance of the Magnetic Association. For his fundamental magnetic researches, Gauss received the Copley Medal in 1838. This was then the highest academic distinction, comparable with the present Nobel Prize (Ref. 51). Later, Weber also

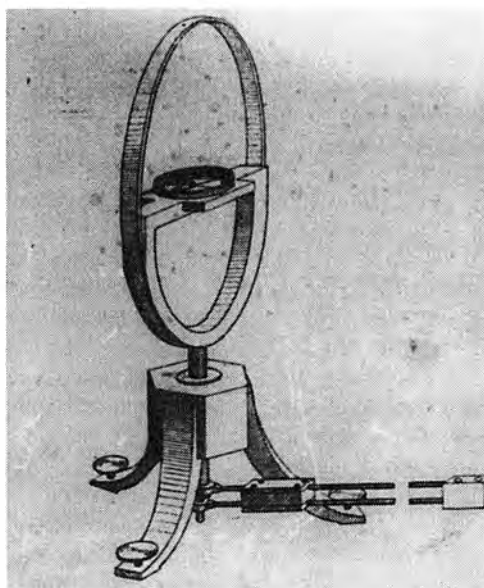

Wilhelm Weber's Werke, Vol. 3, p. 8.

*The tangent galvanometer (Tangentenbussole). With this instrument, Wilhelm Weber carried out the first absolute measurements of electromagnetic currents in 1841. To make the current measurements, the horizontal component of the magnetic field of the Earth must be known, a quantity that was first determined by the magnetic researches which Gauss reported in his Intensity paper of 1832.*



## DETERMINING THE EARTH'S MAGNETIC FORCE: POISSON'S METHOD VERSUS GAUSS'S

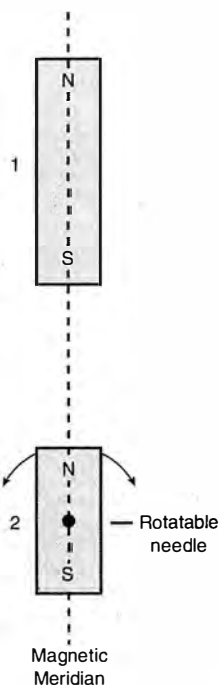

### Poisson's Method

In Poisson's method, the oscillations of the needle marked 2 will be accelerated by the presence of the fixed, first needle, in this configuration where the opposite poles are turned toward each other. A comparison of the number of oscillations in this configuration, to the number of oscillations when the first needle is removed, gives the ratio ( $M/H$ ) of the magnetic force of the first needle to the horizontal intensity of the Earth's magnetic force.

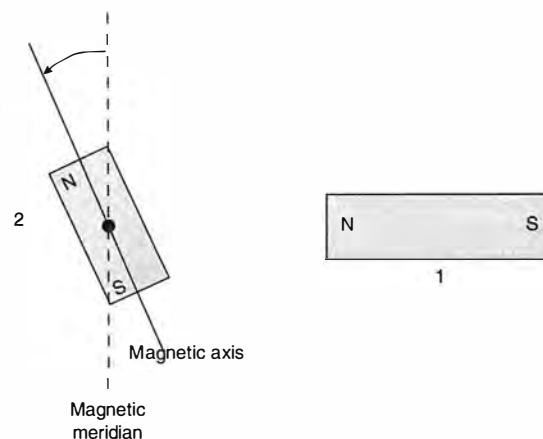

### Gauss's Method

But observations carried out by Poisson's method proved inaccurate. In the configuration conceived by Gauss, needle 1 tends to produce an angular deflection in the second, oscillating needle, while the Earth's magnetism attempts to return the second needle into a line with the magnetic meridian. The resulting angular deflection is proportional to the sought-for ratio  $M/H$ .

received the Copley Medal (Ref. 2, p. 184).

In 1842, Weber obtained a new position as physicist in Leipzig University. After the German Revolution of 1848-1849, which aimed at a greater political freedom and national unity, Weber was able to return to Göttingen University. But his work with Gauss was never continued. Weber retired from his official duties at the age of 70, but remained active in his researches until 1880. He died in Göttingen in 1891.

In the modern International System of Units, the unit of magnetic flux carries the name of weber, following a suggestion first presented by Clausius in 1882 (Ref. 2, p. 137): The unit gauss appears in connection with the density of magnetic flux or magnetic induction, namely, 1 tesla (T) =  $10^4$  gauss (G).

*Andre Koch Torres Assis has been working for 15 years on Weber's electrodynamics, Ampère's force between current elements, and Mach's principle. He is the author of three books in English on these topics.*

*Karin Reich has studied mathematics, physics and astronomy. She has worked on the history of science at the Universities of Munich, Stuttgart, and Hamburg.*

*Karl Heinrich Wiederkehr studied physics, mathematics and chemistry at Hamburg University. He is the author of the only book-length biography of Wilhelm Weber, and many historical papers.*

Assis (assis@ifi.unicamp.br) and Reich (reich@math.uni-hamburg.de) are at the Institut für Geschichte der Naturwissenschaften, Universität Hamburg, Bundesstr. 55, D-20146 Hamburg, Germany. Permanent address of Assis: Institute of Physics, State University of Campinas, 13083-970 Campinas, SP, Brazil. Wiederkehr, is at Birkenau 24, D-22087 Hamburg, Germany.

### Acknowledgments

One of the authors (AKTA) wishes to thank the Alexander von Humboldt Foundation of Germany for a research fellowship during which this work was accomplished. He also thanks Laurence Hecht for permission to quote from the unpublished English translations of the works by Gauss, and by Kohlrausch and Weber.

### Notes

- Key Words:** Magnetism and electromagnetism, absolute system of units, Weber's electrodynamics.  
**PACS:** 01.65.+g (History of science), 06.20.Fn (Units and standards)
- Biographies of Gauss and Weber and discussions of their works with many references can be found in Refs. 1,2,3,4 (especially Vol. 1, Chapters 3, 6 and 7; and Vol. 2, Chapter 17), and Refs. 5, 6, and 7.
- For biographies of Ampère with references see, for instance, Refs. 22, 23, and 24. A discussion of Ampère's force between current elements and its integration for the force between current carrying wires with many references can be found in Refs. 25 and 26.
- In more general terms, Gauss presented this concept in Section 5 of the *Intensity* as follows: Let  $dm$  be the quantity of free magnetism in one particle with coordinates relative to three orthogonal axes as represented by  $x$ ,  $y$ , and  $z$ . By definition the magnetic moment of the body is given by 
$$\vec{M} = M_x \hat{x} + M_y \hat{y} + M_z \hat{z} = \iiint \vec{r} dm$$
 where the integral is over the whole body. The direction of  $\vec{M}$  is called the magnetic axis of the body.

### References

- K. Reich, 1977. *Carl Friedrich Gauss—1777/1977*. (Munich: Heinz Moos Verlag).
- K.H. Wiederkehr, 1967. *Wilhelm Eduard Weber—Erforscher der Wellenbewegung und der Elektrizität (1804-1891)*, Volume 32 of *Grosse Naturforscher*, H. Degen (ed.). (Stuttgart: Wissenschaftliche Verlagsgesellschaft).
- A.E. Woodruff, 1976. "Weber, Wilhelm Eduard," In C.C. Gillispie, editor, *Dictionary of Scientific Biography*, Vol. 14, pp. 203-209. (New York: Scribner).
- C. Jungnickel and R. McCormmach, 1986. *Intellectual Mastery of Nature—Theoretical Physics from Ohm to Einstein*, Vols. 1-2. (Chicago: University of Chicago Press).
- T. Archibald, 1989. "Energy and the Mathematization of Electrodynamics in Germany, 1845-1875," *Archives Internationales d'Histoire des Sciences*, Vol. 39, pp. 276-308.

6. S. D'Agostino, 1996. "Absolute Systems of Units and Dimensions of Physical Quantities: A Link between Weber's Electrodynamics and Maxwell's Electromagnetic Theory of Light." *Physica*, Vol. 33, pp. 5-51.
7. K.H. Wiederkehr, 1997. "Carl Friedrich Gauss (1777-1855) und Wilhelm Weber (1804-1891)." In K.v.Meÿn, editor, *Die Grossen Physiker*, Vol. 1, pp. 357-370 and 522-524. (München: Verlag C. H. Beck).
8. P. Honigmann, 1984. "Entstehung und Schicksal von Humboldts Magnetischem 'Verein' (1829-1834) im Zusammenhang mit seiner Russlandreise," *Annals of Science*, Vol. 41, pp. 57-86.
9. K.-R. Biermann, 1971. "Der Brief Alexander von Humboldts an Wilhelm Weber von Ende 1831—ein bedeutendes Dokument zur Geschichte der Erforschung des Geomagnetismus," *Monatsberichte der Deutschen Akademie der Wissenschaften zu Berlin (DDR)*, Vol. 13, Heft 3, pp. 234-242.
10. K.H. Wiederkehr, 1964. "Aus der Geschichte des Göttinger Magnetischen Vereins und seiner Resultate," *Nachrichten der Akademie der Wissenschaften in Göttingen, II. Mathematisch-Physikalische Klasse*, Vol. 14, pp. 165-205.
11. K.H. Wiederkehr, 1973. "Das bisher unbekannte Gauss-Gutachten zur Wiederbesetzung des Göttinger Physiklehrstuhls 1831," *Gauss-Gesellschaft, Mitteilungen*, Vol. 10, pp. 32-47.
12. C.F. Gauss, 1841. "Intensitas vis magneticae terrestri ad mensuram absolutam revocata," *Commentationes Societatis Regiae Scientiarum Göttingensis Recentiores*, Vol. 8, pp. 3-44. Delivered before the Society in 15 December 1832. Also in C. F. Gauss's *Werke*, Vol. 5, pp. 79-118 (Göttingen: Königliche Gesellschaft der Wissenschaften (ed.), 1867).
13. C.F. Gauss, 1833. "Die Intensität der erdmagnetischen Kraft, zurückgeführt auf absolutes Maass," *Annalen der Physik und Chemie*, J. C. Poggendorff (ed.), Vol. 28, pp. 241-273 and 591-615.
14. C.F. Gauss, 1894. "Die Intensität der erdmagnetischen Kraft auf absolutes Maass zurückgeführt," In E. Dorn, editor, *Ostwald's Klassiker der exakten Wissenschaften*, Vol. 53. (Leipzig: Wilhelm Engelmann Verlag). Translation by Kiel, notes by E. Dorn.
15. C.A.F. Peters (ed.), 1862. *Briefwechsel zwischen C.F. Gauss und H.C. Schumacher*. (Altona: Gustav Esch.). Fourth volume.
16. U.C. Merzbach, 1984. *Carl Friedrich Gauss: A Bibliography*. (Wilmington, Del.: Scholarly Resources Inc.).
17. C.F. Gauss, 1995. "The Intensity of the Earth's Magnetic Force reduced to Absolute Measurement," translated from the German by Susan P. Johnson, edited by L. Hecht, unpublished.
18. L. Hecht, 1996. "Experimental Apparatus and Instrumentation," *21st Century*, Fall, pp. 35-40.
19. E.T. Whittaker, 1973. *A History of the Theories of Aether and Electricity*, volume 1: *The Classical Theories*. (New York: Humanities Press). First published 1910, revised and enlarged edition 1951, reprinted 1958.
20. A.M. Ampère, 1823. "Mémoire sur la théorie mathématique des phénomènes électrodynamiques uniquement déduite de l'expérience," *Mémoires de l'Académie des Sciences de l'Institut de France*, Vol. 6, pp. 175-387.
21. A.M. Ampère, 1965 [1823]. "On the Mathematical Theory of Electrodynamic Phenomena, Experimentally Deduced," In R. A. R. Tricker, *Early Electrodynamics—The First Law of Circulation*, pp. 155-200. (New York: Pergamon).
22. L.P. Williams, 1970. "Ampère, André-Marie," In C. C. Gillispie, editor, *Dictionary of Scientific Biography*, Vol. 1, pp. 139-147. (New York: Scribner).
23. C. Blondel, 1982. *A.-M. Ampère et la Création de l'Électrodynamique (1820-1827)*. (Paris: Bibliothèque Nationale).
24. L.P. Williams, 1989. "André-Marie Ampère," *Scientific American*, January, pp. 72-79.
25. A.K.T. Assis, 1994. *Weber's Electrodynamics*. (Dordrecht: Kluwer Academic Publishers). ISBN: 0-7923-3137-0.
26. M.d.A. Bueno and A.K.T. Assis, 2001. *Inductance and Force Calculations in Electrical Circuits*. (Huntington, New York: Nova Science Publishers). ISBN: 1-56072-917-1.
27. Cl. Schaefer, 1924-1929. "Über Gauss' Physikalische Arbeiten (Magnetismus, Elektrodynamik, Optik)," In Gesellschaft der Wissenschaften zu Göttingen, ed. Carl Friedrich Gauss *Werke*, Vol. 11, Part 2, pp. 1-217. (Berlin: Springer).
28. I. Newton, 1934 [1687]. *Mathematical Principles of Natural Philosophy*. (Berkeley: University of California Press). Cajori edition. Original publication in Latin in 1687.
29. A.K.T. Assis, 1999. *Relational Mechanics*. (Montreal: Apeiron). ISBN: 0-9683689-2-1.
30. A. Coulomb, 1935 [1785]. "First Memoir on Electricity and Magnetism," In W. F. Magie, ed., *A Source Book in Physics*, pp. 408-413. (New York: McGraw-Hill). Original publication in French in 1785.
31. A. Coulomb, 1935 [1785]. "Second Memoir on Electricity and Magnetism," In W. F. Magie, editor, *A Source Book in Physics*, pp. 413-420. (New York: McGraw-Hill). Original publication in French in 1785.
32. W. Weber, 1841. "Messung starker galvanischer Ströme bei geringem Widerstande nach absolutem Maasse," In C. F. Gauss and W. Weber, eds. *Resultate aus den Beobachtungen des magnetischen Vereins im Jahre 1840*, pp. 83-90. (Leipzig: Weidmannschen Buchhandlung). Also in Wilhelm Weber's *Werke*, Vol. 3, H. Weber, ed. (Berlin: Springer, 1893), pp. 6-12.
33. W. Weber, 1842. "Messung starker galvanischer Ströme nach absolutem Maasse," *Annalen der Physik und Chemie*, J. C. Poggendorff (ed.), Vol. 55, pp. 27-32. Also in Wilhelm Weber's *Werke*, Vol. 3, H. Weber, ed. (Berlin: Springer, 1893), pp. 19-23.
34. W. Weber, 1851. "Messungen galvanischer Leitungswiderstände nach einem absolutem Maasse." *Annalen der Physik und Chemie*, J.C. Poggendorff (ed.), Vol. 82, pp. 337-369. Also in Wilhelm Weber's *Werke*, Vol. 3, H. Weber, ed. (Berlin: Springer, 1893), pp. 276-300.
35. W. Weber, 1861. "On the Measurement of Electric Resistance according to an Absolute Standard," *Philosophical Magazine*, Vol. 22, pp. 226-240 and 261-269.
36. J.C. Maxwell, 1954 [1873]. *A Treatise on Electricity and Magnetism*. (New York: Dover). Original publication in 1873.
37. W. Weber, 1852. "Elektrodynamische Maassbestimmungen insbesondere Widerstandsmessungen," *Abhandlungen der Königl. Sächs. Gesellschaft der Wissenschaften, mathematisch-physische Klasse*, Vol. 1, pp. 199-381. Also in Wilhelm Weber's *Werke*, Vol. 3, H. Weber, ed. (Berlin: Springer, 1893), pp. 301-471.
38. W. Weber, 1846. "Elektrodynamische Maassbestimmungen—über ein allgemeines Grundgesetz der elektrischen Wirkung," *Abhandlungen bei Begründung der Königl. Sächs. Gesellschaft der Wissenschaften am Tage der zweihundertjährigen Geburtstagsfeier Leibnizens herausgegeben von der Fürstl. Jablonowskischen Gesellschaft* (Leipzig), pp. 211-378. Also in Wilhelm Weber's *Werke*, Vol. 3, H. Weber, ed. (Berlin: Springer, 1893) pp. 25-214.
39. W. Weber, 1848. "Elektrodynamische Maassbestimmungen." *Annalen der Physik und Chemie*, J. C. Poggendorff (ed.), Vol. 73, pp. 193-240. Also in Wilhelm Weber's *Werke*, Vol. 3, H. Weber, ed. (Berlin: Springer, 1893), pp. 215-254.
40. W. Weber, 1966 [1852]. "On the Measurement of Electro-dynamic Forces," In R. Taylor, ed., *Scientific Memoirs*, Vol. 5, pp. 489-529. (New York: Johnson Reprint Corporation). Original published in 1852.
41. W. Weber and R. Kohlrausch, 1856. "Über die Electricitätsmenge, welche bei galvanischen Strömen durch den Querschnitt der Kette fliesst," *Annalen der Physik und Chemie*, J. C. Poggendorff (ed.), Vol. 99, pp. 10-25. Also in Wilhelm Weber's *Werke*, Vol. 3, H. Weber, ed. (Berlin: Springer, 1893), pp. 597-608.
42. W. Weber and R. Kohlrausch, 1996 [1856]. "On the Amount of Electricity which Flows through the Cross-section of the Circuit in Galvanic Currents," translated from the German by Susan P. Johnson, edited by L. Hecht, unpublished.
43. L. Hecht, 1996. "The Significance of the 1845 Gauss-Weber Correspondence," *21st Century*, Fall, pp. 22-34.
44. W. Weber, 1855. "Vorwort bei der Übergabe der Abhandlung: Elektrodynamische Maassbestimmungen, insbesondere Zurückführung der Stromintensitäts-Messungen auf mechanisches Maass," *Berichte über die Verhandlungen der Königl. Sächs. Gesellschaft der Wissenschaften zu Leipzig, mathematisch-physische Klasse*, Vol. 17, pp. 55-61. Also in Wilhelm Weber's *Werke*, Vol. 3, H. Weber, ed. (Berlin: Springer, 1893), pp. 591-596.
45. R. Kohlrausch and W. Weber, 1857. "Elektrodynamische Maassbestimmungen insbesondere Zurückführung der Stromintensitäts-Messungen auf mechanisches Maass," *Abhandlungen der Königl. Sächs. Gesellschaft der Wissenschaften, mathematisch-physische Klasse*, Vol. 3, pp. 221-290. Also in Wilhelm Weber's *Werke*, Vol. 3, H. Weber, ed. (Berlin: Springer, 1893), pp. 609-676.
46. K.H. Wiederkehr, 1994. "Wilhelm Weber und Maxwells elektromagnetische Lichttheorie," *Gesnerus*, Part. 3/4, Vol. 51, pp. 256-267.
47. A.K.T. Assis, 2000. "The Meaning of the Constant  $c$  in Weber's Electrodynamics," In R. Monti, ed., *Proc. of the Int. Conf. Galileo Back in Italy II*, pp. 23-36. (Bologna: Soc. Ed. Andromeda).
48. C.F. Gauss, 1877. Carl Friedrich Gauss's *Werke*, Vol. 5. (Göttingen: Königlichen Gesellschaft der Wissenschaften zu Göttingen, ed.). Second printing (first printing 1867).
49. W. Schröder and K.H. Wiederkehr, 2000. "Erdmagnetische Forschungen im 19. Jahrhundert," *Sudhoffs Archiv*, Vol. 84, Heft 2, pp. 166-183.
50. K.H. Wiederkehr, 2001. "Das Gauss-Observatorium für Erdmagnetismus und das erste Polarjahr 1882-1883," *Gauss-Gesellschaft, Mitteilungen*, Vol. 38, pp. 29-47.
51. K.H. Wiederkehr, 1982. "Über die Verleihung der Copley-Medaille an Gauss und die Mitarbeit Englands im Göttinger Magnetischen Verein," *Gauss-Gesellschaft, Mitteilungen*, Vol. 19, pp. 15-35.

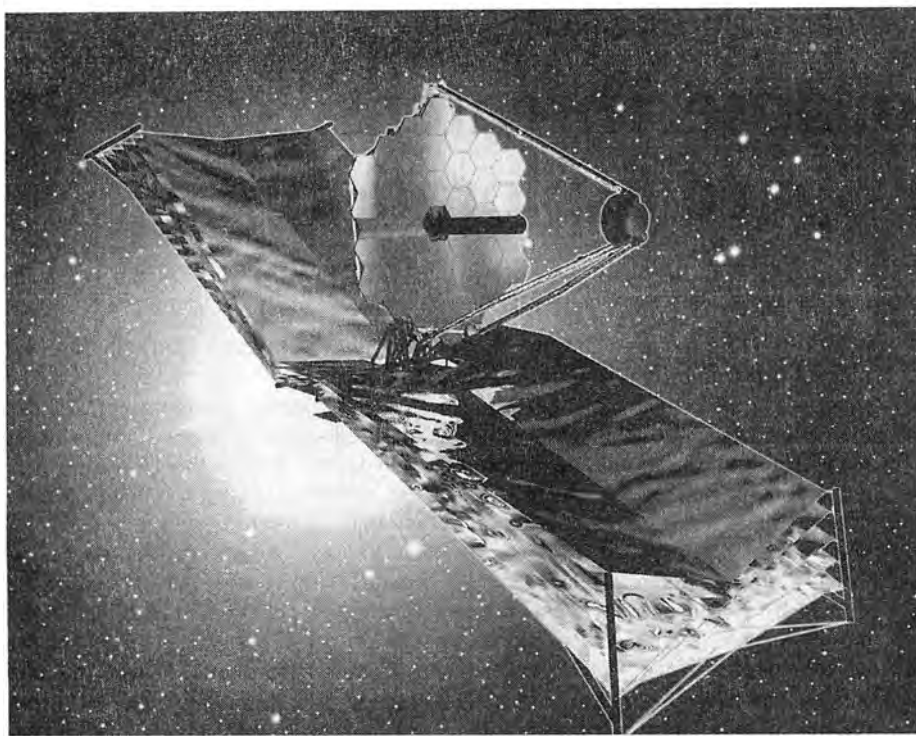

© TRW Inc. 2000

*Artist's illustration of the James Webb Space Telescope (JWST), showing the spacecraft's 6.5-meter primary mirror composed of 36 semi-rigid hexagonal segments, and its deployable, multi-layer sunshield. JWST has about 10 times the light-gathering capabilities of Hubble and will be able to see objects 400 times fainter than those now studied with ground telescopes.*

# An Opening in Astronomy

by David Cherry

**T**here is an opening in astronomy for a few individuals of the right qualifications. The chief of these is a passion for truth, and an indifference to the politics of "getting ahead in the field." The opening arises from a vast contradiction in the practice of astronomy over recent decades, which can be summarized as "advances in telescopes, regression in thought." This state of affairs could go on indefinitely unless one or two—or a few—qualify themselves to take the role that Pasteur took in medicine or that Kepler took in this field.

First, look at the advances, by leaps and bounds, being taken in astronomical observing. The European Southern Observatory (ESO) has recently finished a 10-meter telescope, the Very Large Telescope (VLT) in Chile. Telescope mirrors of 10-meter diameter are the largest in existence, and there is only a small handful of them; less than 10

years ago, there were none. But the ESO is now planning a 100-meter telescope to be called the Overwhelmingly Large Telescope (OWL). Never before in the history of telescope-making has there been a 10-fold increase in mirror size at a single leap. The engineering and materials problems will be daunting.

NASA's Next Generation Space Telescope, named after former NASA Administrator James Webb and contracted to TRW, will have a primary mirror at least 6 meters (20 feet) across, more than double the size of the Hubble Space Telescope, which is already the largest ever in space. The diameter of the new mirror, being greater than that of the largest rocket available to take it up, requires that the mirror be built in pie segments and assemble itself in space. The James Webb Space Telescope, an infrared instrument, instead of being placed in

near-Earth orbit like the Hubble, will go out 940,000 miles and orbit around the so-called second Lagrange point (L2) between Sun and Earth.

A large leap is also occurring in gamma-ray observing. The High Energy Stereoscopic System (HESS) will be an array of gamma-ray telescopes in the Namibian desert in southern Africa, the first of which was inaugurated September 3, 2002. This first telescope by itself is more sensitive than any existing ground-based array, and four telescopes will be functioning by the end of 2003. Its name was chosen to produce the acronym HESS, in memory of Viktor Hess, who won the Nobel prize in physics in 1936 for his discovery of cosmic radiation.

Compare these advances to the state of affairs in 1940. Then, the largest optical telescope was the 100-inch on Mt. Wilson. The radiotelescope was still just a glimmer in the eye of Grote Reber. There were no telescopes above Earth's atmosphere, and so much of the electromagnetic spectrum was simply not accessible.

## What Happened to Thought?

What has happened to physical scientific thought in general—and astro-  
*Continued on page 55*



## REPORT ON THE 2002 WORLD SPACE CONGRESS

# Economic Collapse Threatens Prospects for Space Exploration

by Marsha Freeman



**T**he atmosphere, and the reality, of the second World Space Congress, held Oct. 10-18 in Houston, Texas, were entirely different from that of a decade ago.

Ten years ago, at the first World Space Congress in Washington, D.C., scientists, aerospace industry representatives, and space program officials from around the world were optimistic about the future of space technology development and exploration. The disintegration of the Soviet Union held out the promise of collaboration between the United States and the world's other great space power. With the Cold War over, the aerospace industry looked forward to a "peace dividend," that would free research and development resources from military programs for visionary space initiatives.

The prospects for growth in commercial space services were bright, with plans to orbit dozens of satellites to provide mobile telecommunications and Internet services, requiring the expansion of both satellite-manufacturing facilities, and the launch vehicles to carry them into space.

A few weeks after the World Space Congress, elections would bring Bill Clinton to the White House, his stated policy to "engage," rather than confront the People's Republic of China—the next emerging space power. American satellite makers would be able to launch their spacecraft on Chinese rockets, expanding their business, especially in Asia. The Clinton Administration would invite Russia to join the International Space Station, virtually combining the programs of the world's only two manned-space-exploration powers, to the benefit of both.

Over the past 10 years, the failed economic policies dictated by the International Monetary Fund have come

perilously close to destroying the magnificent capabilities that were the Soviet space program. Similar policies, within the context of the global financial crisis, have led to declines in funding for space exploration by all of the major space powers, and now threaten major programs.

## Caught in Budget Collapse

During the course of the 10-day meeting in Houston, cutbacks and delays were reported:

- A speaker from the U.S. Jet Propulsion Laboratory reported that the Marconi data relay satellite planned for Mars could be delayed because of the funding problems of NASA's partner, the Italian Space Agency.

- The European Space Agency's Venus Express mission faces outright cancellation, if the Italian government, as it has indicated, cannot meet its commitments.

- Kohichiro Ozama reported at the Congress that Japan's Planet C mission to Venus is also on hold, because they do not have enough money to complete even the prototype model. Japan had previously announced that the completion of its contribution to the International Space Station—the Japanese Experiment Module—would be delayed for two years, because of funding problems.

- Describing the French Mars exploration program, Jean-Louis Counil stated that the French Space Agency, CNES, had wanted to launch a mission in 2007 to include a science orbiter and four Net Landers for communications relay and scientific exploration on Mars. But estimates are that the mission would cost 400 to 500 million euros, and the "budget estimates were far too optimistic," he said. Now, the French are looking for "cost reductions," that will

simplify the mission, and will "move it to 2009."

The budgetary problems of the two manned-space powers were already well known before the Houston meeting, with Russia stating it does not have enough money to build the Soyuz rockets to carry supplies and crew to the space station, and the United States threatening not to finish building the station.

In the United States over the past decade, the decline in defense spending, with no parallel increase in the civilian space program, has led to hundreds of thousands of layoffs in aerospace, and dozens of company mergers that reduced capacity in every sector of the industry. What remains are a few mega-giants, increasingly dependent for survival upon money from the Department of Defense.

The collapse of the telecommunications sector, bloated by speculative ventures and hyped high-priced services, has led to the cancellation of dozens of satellite launches and created an "overcapacity" of launch vehicles, leaving in the red companies that invested millions of dollars to develop new rockets. Michael Yarymovych, the president of the International Academy of Astronautics, stated on Oct. 13 that the community is in a "malaise," and that it will take the launch vehicle industry "a decade to catch up again."

## Bush Policy Cuts Attendance

As the U.S. and world economies tumble, the Bush Administration is pursuing a "Clash of Civilizations" foreign policy, which precludes engaging dozens of nations in collaboration in space exploration—a program of technological apartheid under the guise of fighting terrorism.

One of their first discoveries of the conference delegates in Houston was that many of the papers that were listed in the program would not be presented, because the scientists could not get U.S. visas to attend. Eighty Chinese scientists (nearly the entire delegation) were denied visas by the U.S. State Department. *Aviation Week* subsequently reported that Luan Enjie, the head of the Chinese space agency, was left stranded in Canada, unable to enter the United States. In addition, Russian, Indonesian, Romanian, Iranian, and Algerian scientists were denied visas.

The visas were denied, or "delayed" long enough to cancel participation, under the guise of fears of "technology transfer" to these nations. This is an obvious sham, considering that all of the presentations were unclassified and civilian in character, often accessible through the Internet, and will be available later as conference proceedings. One real result was the loss of the opportunity to hear from Chinese scientists what their otherwise quite secret space program was planning.

Ironically, the President of China, Jiang Zemin, visited the NASA Johnson Space Center in Houston less than a week after the conference that his nation's space experts were not allowed to attend.

In response to this slap in the face to the international scientific community, Marcio Barbosa, the Brazilian national who heads one of the main sponsoring organizations—the International Astronautical Federation—has sent a letter of complaint to the American Academy of Sciences, and the American Institute of Aeronautics and Astronautics, the U.S. hosts for the Houston Congress. The international scientific organizations indicated at the close of the conference that they will recommend that no future such meetings be held in the United States. The Bush Administration policy is "insane," one French Congress official told this reporter.

Despite this attempted sabotage of a crucial opportunity for the space community to meet,

discuss, review programs, and plan for the future, and despite the economic crisis, which is "downsizing" the programs of the space-faring nations, there were new, innovative ideas presented, and many developing nations made clear they intend to be part of space exploration in the 21st Century.

#### Ibero-America Still Committed

No countries represented at the World Space Congress are facing a more severe financial crisis than Ibero-America's two space powers, Argentina and Brazil. Yet, both nations made clear they will continue their programs, with or without the United States, and in spite of their current economic catastrophes. Marcio Barbosa stated, at a plenary session titled "Space Activities: An Engine for Serving Humanity," that with "courage and determination," mankind "could go back to the Moon in six years." He called for a "dialogue to build a bridge to solve the problems of humanity."

Throughout the 1970s and 1980s, the "empire" faction in the U.S. government, following former Secretary of State Henry Kissinger's dictum that there should be no economic powers allowed to develop in the South, tried desperately to stop the space programs of Argentina and Brazil. Particularly targeted were their launch vehicle development programs; these rockets, the United States insisted and continues to

insist, were not being developed to launch satellites into orbit, but as missiles, to carry "weapons of mass destruction." The United States lied that international non-proliferation treaties would not prevent Ibero-American nations from developing space technology, but the Missile Technology Control Regime (MTCR), in fact, classifies any launch vehicle, and all its components, as a weapon or weapons. (For a detailed report on this situation, see the author's "Ibero-America Needs a Space Agency," *21st Century*, Spring 2002, pp. 31-54.)

Bowing to U.S. pressure, with the hope of gaining access to the technology it needed to upgrade its other space efforts, Argentina cancelled its Condor rocket program in 1990, and in 1991, signed the MTCR. But Brazil refused to capitulate, and continues to develop its independent launch capability, the Satellite Launch Vehicle (VLS). The next test launch, it was announced at the Houston Congress, is scheduled for March 2003.

At a session on space law at the conference, representatives from Brazil registered their objection to U.S. export control policy, and their determination to look elsewhere for cooperation in space. José Monserrat Filho, head of the Brazilian Society of Space Law in Rio de Janeiro, described the current U.S. dominance over technology-



Surrey Satellite Technology

*Nigeria's space program is working on satellites for disaster monitoring and communications infrastructure. Here, Turner T. Isoun, Nigeria's Minister for Science and Technology (right), signing an agreement with Surrey Satellite Technology, Ltd. in November 2000 for its first space satellite. Signing for Surrey is Dr. Martin Sweeting (left).*

transfer policy as a "hegemony" that has developed from a "unipolar" world.

In 1996, the United States and Brazil signed a Framework Agreement on Cooperation in the Peaceful Uses of Outer Space. In 1999, President Bill Clinton met in Washington with Brazilian President Fernando Henrique Cardoso, and the next year, an agreement was signed outlining the use of Brazil's Alcântara launch site by American launch vehicles, and to launch American-built satellites. To this day, the Brazilian Houses of Congress have refused to ratify the agreement.

The reason is that, while the Technology Safeguards Agreement with the United States proposes to prevent unauthorized vehicle and satellite technology transfer to Brazilian institutions and companies at the Alcântara spaceport in return for cooperation, in fact, that cooperation will not exist unless Brazil cancels its VLS rocket program. The Brazilian Congress rightly sees the agreement as a threat to its national sovereignty.

As Monserrat stated, the agreement is not: "an instrument of cooperation, but of technological safeguards. It would be a true instrument of cooperation if it would provide some technological transfer, train human resources, or contribute to the development of the Brazilian national space program. That is not the case."

The U.S. safeguards are aimed "at the VLS," Monserrat stated, "since the United States never accepted the VLS program," even though Brazil joined the Missile Technology Control Regime in 1995. "Apparently, Brazil's decision to join the MTCR does not guarantee Brazil a more trustworthy and flexible treatment by the U.S."

#### **Africa Into Space**

The same determination evidenced at the World Space Congress by Brazil and Argentina was demonstrated by numerous developing nations, which do not plan to be left in the backwaters of science and technology or economic progress. A number of developing countries are entering the space age through a cooperative program initiated at the University of Surrey, England. (See "Surrey's Nano-Satellites: Bring-

ing Developing Nations into the Space Age," *21st Century*, Summer 2002, pp. 55-57.)

At the Congress of the International Astronautical Federation in Toulouse last year, researchers from Algeria's Centre National des Techniques Spatiales described the importance, for their nation and North Africa, of their Disaster Monitoring Satellite, stating that with this project, "space is no longer the preserve of a few wealthy nations."

This year, at the World Space Congress, Prof. Robert Boroffice, who heads the National Space Research and Development Agency of Nigeria, discussed his country's participation in space technology development. "Space technology and access to space have been elusive to most developing countries over the last half of the 20th Century," he stated, as "technology was seen as very expensive and prestigious, meant only for the major industrialized countries."

But over the last decade, Boroffice said, "the trend has changed, with many developing countries embracing space technology as one of the major ways to achieve sustainable development. The present trend toward the use of small satellites in meeting national needs has aided this transition."

"Nigeria is a country at the threshold of technology development and industrialization," Boroffice stated. "It has a population of 88.5 million (1991 census) . . . with a wide variety of natural resources." He explained that "the prime objective" of the government of Nigeria is "the provision of adequate food, clean drinking water, shelter, health care delivery, good roads, and infrastructure for development, especially for rural dwellers, who constitute about 80 percent of the population."

Although the value of satellite remote sensing data for development planning has long been recognized, Boroffice said, the absence of ground receiving stations in most developing nations means they have had to purchase the data at a high cost. Now Nigeria will be able to have its own, independent capability.

The Nigerian National Space Research and Development Agency was established in 1999, he reported. The objectives are to "develop indige-

nous capabilities for research and development in the major areas of space science and technology," to manage natural resources, to develop an "effective and efficient communications system," and to train Nigerians "in the acquisition and application of modern technology."

In order to achieve the broad-ranging objectives of its national space plan, Nigeria has created three new centers, for Basic Space Science, for Satellite Technology Development, and for Geodesy and Geodynamics. To develop the human resources required, and to meet the objective of developing Nigerian technological products that can "feed our manufacturing industries," the study of space science is being made mandatory at all levels of education. There is a plan to develop facilities, such as planetaria, for public education.

In the first step of its national program plan, Nigeria is contributing a satellite to the Disaster Monitoring Constellation. For 15 months, 15 Nigerian engineers were trained at Surrey. Based on the success of that program, the government has decided to initiate a "second national project," NigeriaSAT-2, which is a small geostationary communications satellite "that has been selected specifically to address the lack of communications infrastructure in Nigeria."

"Experiences in other developing countries, such as India and Indonesia, have shown how satellite-based communication systems have opened up the rural areas of development," Boroffice stated. NigeriaSAT-2 will provide "independent communications coverage throughout Nigeria and regional coverage to some West African countries."

In sum, Boroffice said, "a well-funded space program will be a demonstration of the political will to acquire this strategic technology which is crucial to socioeconomic development, and national security."

#### **The Moon or Mars?**

While many developing nations reported to the Congress on their progress in entering the space age, representatives from the already established space powers were trying to find their way back to a vision of the

future.

Throughout a series of presentations at the World Space Congress, Dr. Wesley Huntress, former NASA Associate Administrator for Space Science, and currently Director of the Carnegie Institution's Geophysical Laboratory, stated that what distinguishes the past from the present is that 50 years ago, even though we did not have a space program, "we had a vision." That vision, he said, "was spelled out by Wernher von Braun," in a 1950s series for *Colliers* magazine.

"We had a vision for going to the Moon," Huntress recalled. Walt Disney produced television shows in 1954, with the help of von Braun, showing what the future of space exploration would be, including enormous space stations, then lunar landings, and finally, manned missions to Mars.

"We lost that vision after we went to the Moon," Huntress said, and since then we have just "huddled together," stuck in Earth orbit. Actually, as was pointed out by lunar scientist Paul Spudis, from the Johns Hopkins Applied Physics Laboratory, the Apollo program was a diversion from Wernher von Braun's incremental architecture. But it did create a vast infrastructure, which put almost any destination within reach. The von Braun plan had been, first, to enable people to live and work in nearby low-Earth orbit, providing them with reliable transportation to and from space, and living quarters. Then, a large, multi-use space station in orbit would be used to train astronauts to live in microgravity, and assemble, check-out, and fuel the large spacecraft heading to the Moon and later to Mars.

Huntress pointed out that what the space program needs now is "a destination, and not a piece of hardware." The International Space Station is not an end in itself, but a jumping-off point to somewhere else. For the past 50 years, it has been assumed that this "somewhere else" would first be the Moon, where scientific research, technology development and testing, and industrial manufacturing capability would lay the basis for going the tens of millions of miles to Mars.

Over the past few years, however, there has been a drumbeat to forget

about going back to the Moon, and instead head straight for Mars. The announcement in 1996 by a team of scientists, proposing that artifacts found in a meteorite from Mars indicated the fossil remains of life, heightened public and scientific interest in the possibility that life exists, or existed, on the red planet.

On July 4, 1997, the diminutive Sojourner rover landed on Mars, and captivated the world with its plodding excursions over the Martian surface. Perhaps, some at the space agency thought, this renewed public excitement about Mars could be leveraged into Congressional support for increased NASA funding. Increased emphasis was put on the series of robotic Mars missions which NASA is in the midst of carrying out, and the question of finding life on Mars became their organizing principle.

There is no question that the unmanned exploration of Mars must be carried out with a steady commitment over decades, and long-term planning and funding, to culminate in the human exploration and settlement of the red planet. But the 1998 founding of the Mars Society, and the high-profile organizing campaign by its founder, Robert Zubrin, threw rational long-term planning out the window, in exchange for the ephemeral promise of a "quick fix" for the space program.

The public will not be excited by, or support, a manned return to the Moon, Zubrin insisted, because we've "been there, done that." The Moon is "not interesting," he often repeated, and will only divert scarce resources from the manned Mars mission. Because there is little (if any) money available now for future manned missions, Zubrin based his ill-conceived "Mars Direct" proposal on conventional technology, with the objective of launching crews to Mars within a decade, (before elected representatives lose interest in the project), spending as little money as possible.

At the World Space Congress, the issue of whether the next target for human exploration beyond Earth orbit should be the Moon or Mars, was crystallized in a debate between Zubrin and Paul Spudis, attended by hundreds of

conference delegates. The debate, and companion technical sessions, allowed Spudis and the lunar proponents to make an eloquent case for the need to return to the Moon.

Spudis answered the question, "Why the Moon?" by stating: "It's close, it's easy to get to, it's an interesting place to study, it's got what we need to survive, it's on the way to everywhere else." Also important, for the first long-term human venture off this planet, the Earth is always visible in the sky, and the Moon can be reached easily in a few days. Spudis described it as a "miniature museum of geological processes and history, the study of which is relevant to all of the terrestrial planets." With its airless surface, the Moon contains a record of events in the Solar System, including the history of the Sun, over the last 4 billion years.

According to NASA, scientists attending a recent meeting in Crete proposed that the Moon may also contain a record of the early history of the Earth, which has been erased through millennia of tectonic, volcanic, and climatological processes. Lunar meteorites are found on the Earth. Why shouldn't pieces of the Earth that were blasted off by large impacts, be spewed over the surface of the Moon? A recent study indicates that as much as 20,000 kg of Earth material might be found in every 100 square kilometers of the Moon.

The most important thing we will learn on the Moon, Spudis stated, is how to process and use extraterrestrial resources. The ice recently discovered at the lunar South Pole "is enough to fill a small lake," estimated at 10 billion tons. The Moon is a "permanent space station," Spudis said, and we should use it to "learn to live off-planet." We can use it to "learn how to explore, and bootstrap cislunar infrastructure to go elsewhere."

Over the course of the Congress, Spudis proposed that there should be a human return to the Moon within five years. Existing technology could be used for the initial missions, and each would build up the infrastructure, leading to a permanent human presence. During the 10-day World Space Congress, innovative proposals were presented, by younger participants, for

using the Moon as a platform for astronomy; and the unmanned lunar missions that are already under development in Europe and Japan, and under consideration in India, were described.

Veteran astronaut John Young expressed his support for manned lunar exploration at the Congress, by quoting space visionary Krafft Ehrlicke: "If God had wanted man to explore space, He would have given him a Moon."

#### Possible Next Steps From Earth Orbit

Former NASA official Huntress told a press conference on the last day of the Congress, that for many years, the space agency was "forbidden by the Administration and the Congress from having a plan" for future human space exploration. "This shackle has been lifted in the last few months," he stated, referring to a number of ongoing studies—by the Aurora project of the European Space Agency, the International Academy of Astronautics, and the long-range planning group, NASA Exploration Team, (abbreviated NExT)—which are developing possible scenarios for programs beyond the space station.

"It reminds of just a few months into the Apollo program," Huntress said, when different scenarios were debated "when we had to decide how to go to the Moon."

In a paper titled, "Innovations in Mission Architecture for Exploration Beyond Earth Orbit," a team from the NASA Johnson Space Center and the Jet Propulsion Laboratory presented preliminary results from the NExT study. The motivation, as they explain it, is to "enable a stepping stone approach to science-driven, technology-enabled, human and robotic exploration." The strategy aims to "extend remote sensing of the planets and stars," to "expand the knowledge return from [unmanned] spacecraft," and to identify technologies that "enable exploration by humans beyond low Earth orbit."

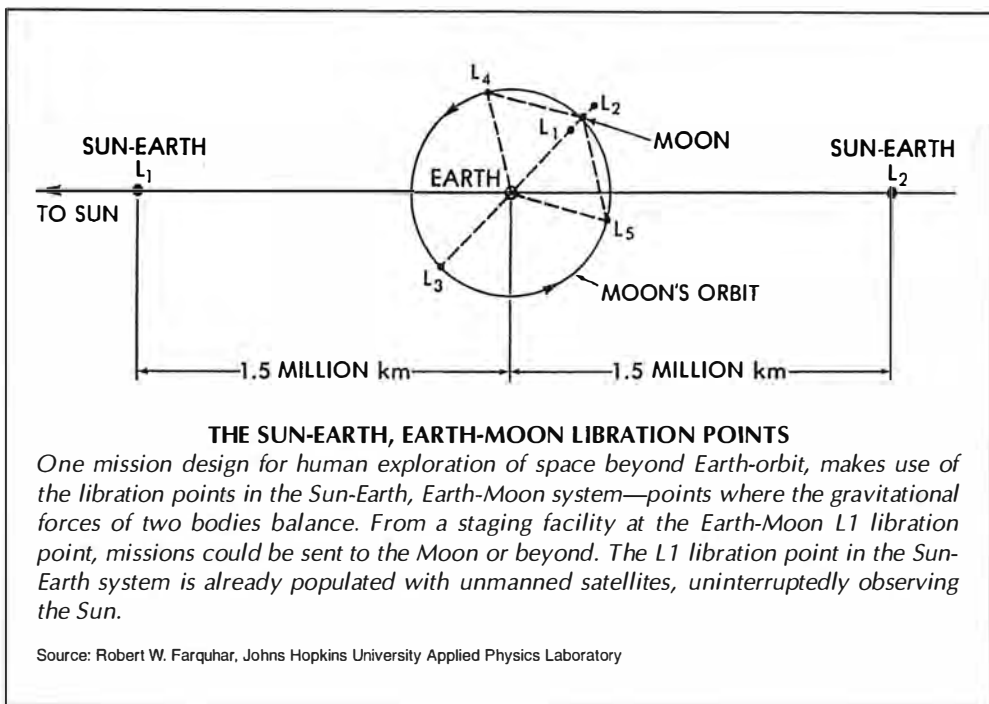

They caution that the design concepts presented are used as "existence proofs and are not presumed to be final designs." There is no doubt that what they presented will be hotly debated in the space community.

Basically, the NASA team decided to dodge the bullet, by not endorsing either a Moon or Mars human exploration mission, but instead laying out an interim architecture that positions the space agency to carry out either, when a political decision is made.

Space historian Howard McCurdy commented on the NExT proposal to *space.com* on Sept. 26, aptly stating: "This incremental step-at-a-time approach was adopted by space advocates after President Nixon, in 1970, denied the request for a comprehensive long-range plan." NASA's current leaders "have chosen to pursue this goal incrementally because they were told not to divert their attention beyond the space station until that project neared completion. Not only are they ready to undertake missions beyond, they have been waiting to do so since the agency was born."

The NExT proposal would take advantage of a feature of orbital mechanics that creates libration points between two large bodies in space, where the gravitational force between

them reaches a kind of equilibrium. A small body placed at these libration points will remain somewhat at rest in relation to the large bodies, in a relatively stable position. In the Earth-Moon, and Earth-Sun relationship, there are a variety of libration points, as seen in the figure. From these null-gravity, stable points in space, it is possible to travel anywhere else in the Solar System expending very little energy.

There are some locations that are preferable for the deployment of astronomical observatories. Already, telescopes, including the Solar Heliospheric Observatory (SOHO) and Advanced Composition Explorer, have been placed at the Sun-Earth L1 libration point, about 1.5 million kilometers (900,000 miles) from Earth, to obtain an uninterrupted view of the Sun. The planned follow-up for the Hubble Space Telescope will be placed there, as well.

One of the objections to the placement of expensive and delicate telescopes, such as the upcoming James Webb Space Telescope, at the Sun-Earth L1 libration point, is that they cannot be serviced by astronauts from the Space Shuttle. The successful repair, maintenance, and upgrading of the Hubble Space Telescope by astro-



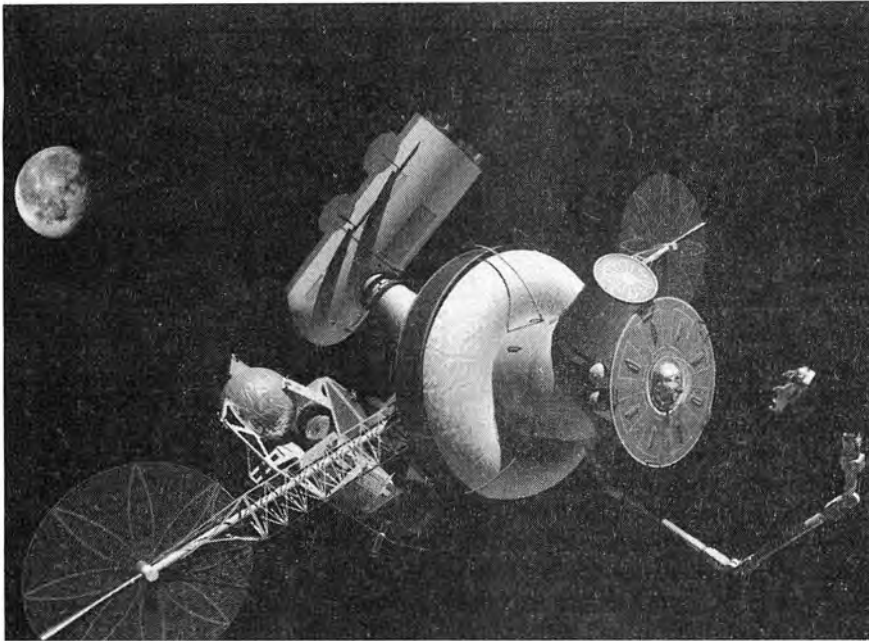

NASA's Exploration Team has proposed that a "Gateway" facility be built at the Earth-Moon L1 point, 322,127 km (about 190,000 miles) from Earth. The facility would include temporary living quarters for visiting crew, facilities to service astronomical observatories, and vehicle fueling and servicing centers for journeys to the Moon and Mars.

nauts has made it into the magnificent facility that it is.

#### Using Libration Points

In his Congress presentation, on "Utilization of Libration Points for Human Exploration in the Sun-Earth-Moon System and Beyond," long-time space planner Robert Farquhar detailed the new astronomy missions slated to be deployed at Sun-Earth libration points over the next 10 years. He proposed that the telescopes could be robotically transferred, over a matter of days, from their observational position, to a libration point in the closer Earth-Moon system, only 323,110 kilometers (about 190,000 miles) from Earth, for periodic servicing by astronauts.

The NExT team proposes the emplacement of infrastructure at the Earth-Moon L2 point, to create a "Gateway," that will allow servicing of in-space facilities, and "support the range of potential destinations."

In Farquhar's design, a Deep-Space Shuttle would operate between the space station and Earth-Moon L2 libration point, and an Interplanetary Transfer Vehicle, stationed in the vicinity of the Earth-Moon L2 Gateway, could transport astronauts to their next stop. Reusable

lunar landing vehicles could be stationed in the vicinity of the Earth-Moon libration point. Landing on the Moon from the libration point reduces the constraints, as compared to going directly from the Earth or from lunar orbit. Landings could take place at any time, and at any site on the Moon, such as the icy poles—not just in the equatorial regions, as were done in the Apollo program.

The NExT team also outlined their scenario for travelling from the Earth-Moon L2 Gateway to Mars, estimating that with advanced technologies—such as nuclear propulsion—significantly shorter travel times and increased payload capacity would result.

In her remarks to the Congress, astronaut and Chief Scientist at NASA headquarters, Shannon Lucid, made her case for visionary human exploration missions, noting that the session was taking place the day after Columbus Day. "Ancient sailors hugged the coastlines," she said. "Today we hug the rim of our planet." The International Space Station, which will help us answer the questions we need to know in order to explore further, she said, should be seen as the "pit-stop to the planets."

## An Opening in Astronomy

*Continued from page 49*

my and astrophysics in particular, for present purposes—in the period since about 1920? There has been a twofold process. One tendency has been increasing to take purely mathematical results as the basis for physical predictions. A second tendency has been to abandon the approach of working outward from what is known with most certainty; in its place, the emphasis is put on areas in which our foundations are weak, and "progress" is only possible with arbitrary assumptions for a foundation and ad hoc speculations from there. The two tendencies are strongly complementary, since mathematics becomes a major tool for producing some speculations, and for dressing up others.

The combined process is not optional, but mandatory, because General Relativity and the Big Bang cosmological framework that have been the vehicles for the process have the institutional authority of organized astronomy behind it.

This twofold process strongly brings to mind the developments in the world economy that have become so pronounced in the period since President Nixon inaugurated floating exchange rates in 1971! First process: Money, not the physical goods or processes it reflects, has become the overriding object of interest. Second process: Instead of building on the things we know (or knew) represent the basis for human improvement, such as expanding per capita energy production, transport capacity, education, and medical facilities, we have allowed these forms of development to be crushed by speculative investments in glitzy things that, no matter how profitable to a few, are actually harmful to the advance of our cognitive powers. We have exploitation of sex, drugs, HBO, and videogames. Marijuana is the biggest cash crop in the United States.

The analogy is hardly exact. But analogy aside, one wonders how much the decay in popular economic thinking has exacerbated the worst tendencies of astronomers' thinking.

# Great Art Requires More Than Optical Technology

by Karel Vereycken

**Secret Knowledge: Rediscovering the Lost Techniques of the Old Masters**

by David Hockney  
New York: Penguin Putnam Inc., 2001  
Hardcover, 296 pp., \$60.00

To glorify contemporary artist David Hockney's two years' investigation as "a sensational discovery that became the subject of headlines, and media attention and debate among prominent scientists, art historians, and museum directors worldwide" (as one promoter of this book did) is overdone.

Trained at the age of 16 at the Bradley School of Art in England, where he did

drawing four days a week from a life model, author David Hockney proudly writes today, "I am probably one of the last people trained in the old art school ways." Although his conclusions are sometimes brilliant observations of one who knows "how to look," the "secret knowledge" he discovered has the dimension of what the English call a "tempest in a teapot." But, as another old saying goes: In the land of the blind, the one-eyed is king.

The two-year inquiry, debate, and

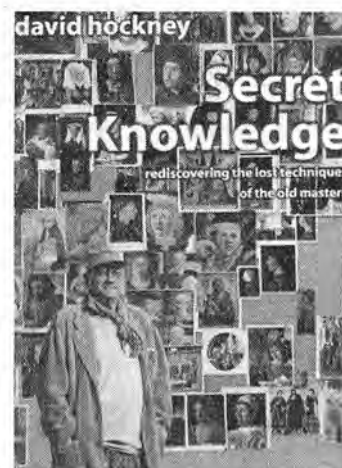

epistolary exchanges between Hockney and some of his professional friends, such as the Newton-loving Leonardo expert Martin Kemp, nevertheless gave birth to a little messy but useful and



**Figure 1**  
**TWO TYPES OF DRAWING**  
*Portrait of Mme. Louis-François Godinot, 1829, by Jean Ingres, in the Collection of André Bromberg, Paris.*

Source: Photograph by Sothby's, Paris.

**Figure 2**  
**THE CAMERA LUCIDA OR LIGHT ROOM**

The camera lucida, shown here in a diagram, was invented by the English chemist W.H. Wollaston (1766-1828), who described it as follows:

"The principles on which it is constructed will probably be most distinctly explained by tracing the successive steps, by which I proceeded in its formation. While I look directly down at a sheet of paper on my table, if I hold between my eye and the paper a piece of plain glass, inclined from me downwards at an angle of 45°, I see by reflection the view that is before me, in the same direction that I see my paper through the glass. I might then take a sketch of it; but the position of the objects would be reversed. To obtain a direct view, it is necessary to have two reflections. The transparent glass must for this purpose be inclined to the perpendicular line of sight only the half of 45°, that it may reflect the view a second time from a piece of looking glass placed beneath it, and inclined upwards at an equal angle. The objects now appear as if seen through the paper in the same place as before; but they are direct instead of being inverted, and they may be discerned in this manner sufficiently well for determining the principal positions. . . ."

Source: D. Hockney, *Secret Knowledge: Rediscovering the Lost Techniques of the Old Masters*

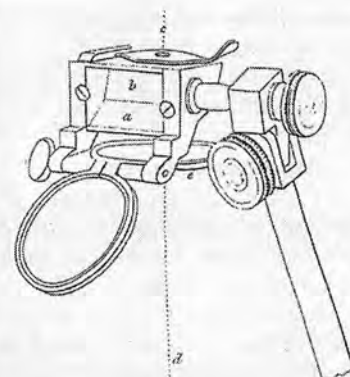

sympathetic book. Hockney's "revelation" started when he visited the Ingres exhibition at the National Gallery in London in January 1999. A close look at Ingres's drawings, allowed him to identify two sharply contrasting ways in which Ingres handles the pencil, including differences within a single drawing.

For example, take the difference between the face and the clothes in the 1829 Ingres drawing of Mme. Louis-François Godinot (Figure 1). The first method of drawing is called "eyeballing," which is even more visible in Ingres's smaller drawings of arms and hands, where he shows a typical "groping": This is the hesitating search for the adequate line able to catch the ephemeral manifestation of life and form, as visible in the face of Mme. Godinot.

The second method of drawing, as seen in the rendering of her clothes,

produces a full-of-confidence, continuous line. This is similar to those seen in Pop artist Andy Warhol's drawings, when he contours on a board images projected from a slide projector. Ingres's drawing strongly suggested to researchers the use of an artists' instrument, made in 1806, called the *camera lucida* (Figure 2).

Hockney writes that "the camera lucida is not easy to use. Basically, it is a prism on a stick that creates the illusion of an image of whatever is in front of it on a piece of paper below. This image is not real—it is not actually on the paper, it only seems to be there. . . . Because it is portable and can be carried anywhere, it is perfect for drawing landscapes."

This discovery got him so excited, that he began a re-examination of all the visual heritage of the past, tracking down, detective-style, anything that was able to serve as proof, witness, indication, or example of the use of optical devices by the old masters. The recent brawl over Vermeer's supposed use of a "camera obscura" (box, p. 59) made Hockney's curiosity even stronger.

#### A Great Wall of Images

To visualize his thoughts, Hockney took the longest wall of his studio in

California and pasted up hundreds of portraits, trying to bring coherence in his ideas about the evolution of the image over centuries. By looking at his "Great Wall," he realized that there was a sudden, brutal change in handling of the image at the time of the early Renaissance—a change most prominent in Flanders. That sudden eruption of "naturalism" became apparent through the rendering of the individual's details, such as skin folding or double chin. There was also the appearance of strong shadows, indicating a powerful source of light.

Hockney writes: "The sudden change I could see suggested to me a technical innovation rather than a new way of looking that then led to a progressive development of drawing skills." In Flanders, at the same time, notably in Roger Campin's and Van Eyck's paintings of the 1430s, appear two basic optical instruments: convex mirrors (easier to make than flat mirrors) and lenses.

With a simple shaving mirror (which is not convex, but concave, and which has technical challenges required to manufacture it, which Hockney avoids), the author did an amusing experiment:

"To make the projected images even



Figure 3

#### BASIC OPTICAL INSTRUMENTS

This detail from the 1438 Heinrich von Werl triptych, by Robert Campin, shows a convex mirror. The painting is at the Museo del Prado, Madrid.



Figure 4

#### HOCKNEY'S MIRROR AND DARK ROOM METHOD

The mirror-lens set-up (with curtain pulled away to show inside the darkened room).

Source: D. Hockney, *Secret Knowledge: Rediscovering the Lost Techniques of the Old Masters*; photo by Richard Schmidt.



(a)



(b)

**Figure 5**  
**TWO PORTRAITS OF**  
**CARDINAL NICCOLO ALBERGATI**  
*Both the silverpoint drawing of the*  
*Cardinal (a) and the oil on wood (b)*  
*by Jan Van Eyck (1431) are in the*  
*Kunsthistorisches Museum, Vienna.*

clearer I cut a hole in a piece of board to make a little window like those I had seen in Netherlandish portraits. I then placed this board in a doorway and blacked the room. I pinned a piece of paper next to the hole, inside the darkened room, and set up the mirror opposite the window and turned it slightly towards the paper. Then a friend sat outside the hole in the bright sunlight. Inside the room, I could see his face on the paper, upside down but right way round and very clear. Because the image was not reversed I was able to make a few key 'measurements' and mark out the corners of the eyes, nose, mouth, just like I had done with the camera lucida. Then I took the paper down, turned it right up and worked from life. . ." (Figure 4).

#### Fallacies of Composition

So far, so good, and lots of fun. But then, several fallacies of composition enter. Overwhelmed by an all-explaining surge of enthusiasm, Hockney lines up a considerable amount of errors and "anomalies" in European painting, all of them, of course, explainable by the use, bad use, or non-use of optical devices. In this, he reminds us of the discoverers of "the libido" or those of "genetics," who imagined their discovery gave them the cosmic key to apprehend the alpha and omega of the universe.

Hockney ends up with an historical time-line, trying to classify painters into two schools: the "eyeballing/geometrical" school and the "lenses/optical" one. Some painters, obviously, were part of both of them, while others were dominantly on one side. Because most of the arguments are "demonstrated" through the 460 illustrations of the book, it is not possible to go through all of them here.

Admittedly, several of these explanations appear fairly credible, as the cases of the Italian Caravaggio and the Dutch Honthorst, two fashionable painters, hunting easy glory and fast income, who were obviously out to gain time, and would be eager to use optical devices for that purpose.

Other arguments, such as left-handed drinkers, supposedly indicating mirror projections; multi-focussed compositions; and nonlinear perspectives do not appear credible. The worst case of lack of rigor, presented as a valuable piece of Hockney's "proof," is his analysis of Van Eyck's portrait of Cardinal Albergati (Figures 5a and b), who presided over the Council of Florence in 1438 (p. 78). This is an explanation which Hockney largely derives from an exchange with professor Charles Falco of the University of Arizona at Tucson:

"Van Eyck's drawing of the cardinal is about 48 percent life size, but the

painting is 41 percent larger than the drawing. What is amazing is that when you enlarge the drawing by that amount and lay it over the painting, many of the features line up exactly: the forehead and the right cheek, the nose and the nostrils, the mouth and the lips, the eyes and the laughter lines—all align perfectly. Now shift the drawing up the right by just 2 mm and the neck and the collar match; shift it up by 4 mm and the ear and the left shoulder are spot on."

Obviously, here the "proof" is somehow contaminated by the desire to be right. Let's be honest: Either it fits, or it doesn't. When it fits, it's a "good proof," and when it doesn't fit, the painter is accused of having drawn an inappropriate gesture! Moreover, I can add from my own experience as drawing teacher, that pupils can be trained to copy the exact size of models, with precision near to the millimeter!

#### Missing Pieces

Another weak part of Hockney's thesis is the missing pieces of his "Great Wall." Notably missing are the classical figurative Greek painting of Apelles, the school of Sycione as recounted in Plinius the Elder, and the Greek influence in Egypt. This last is shown by the very realistic "mummy"-portraits painted in the Faiyûm region of Egypt, west of the Nile, during the 1st Century A.D., more than a thousand years before the production of lenses and mirrors in Flanders (Figure 6)!<sup>1</sup>

Even more regrettable is the fact that Hockney does not really clarify the ambiguous case of Johannes Vermeer. Vermeer, a close friend of Anthony van Leeuwenhoek, the inventor of the microscope and a Leibniz correspondent, seemed totally fascinated and charmed by the poetical power of images produced by such "camera obscura" devices. But for Hockney, technical arguments overrule poetry. He writes:

"Foreground objects and figures are sometimes very large; some things are painted in soft focus, or out of focus all together. In the painting of the milkmaid, for example, the basket in the foreground is out of focus compared with the basket hanging up behind, a distortion Vermeer would not have seen with the naked eye. Nor could he have ren-



**Figure 6**  
**AN EGYPTIAN MUMMY PORTRAIT,**  
**1st CENTURY A.D.**  
*One of several life-like Faiyûm por-*  
*traits.*  
 Bildarchiv Preussische Kulturbesitz

But Allan Mills, an astronomer and expert on early optics, argues that there is no solid proof of Vermeer's use of such a device, because the quality of the images produced by single lenses would have been so poor at this period, as to render them valueless for painters. Mills says that the lines become slightly curved, poorer in focus, and less bright at the edge of the image, an effect known as "vignetting."

According to Mills, proponents of the contrary view, like Hockney, are misled by the superb quality of images obtained by modern cameras.

After many acrobatical half-demonstrations, Hockney realizes that his thesis "it is that simple," somehow spoils not only his scientific but also his artistic credibility, and reduces the making of art to a barely technical performance. After all, lenses and mirrors have no brains, which mean that if it is all

easily done by optics, the art is gone . . . and so is the artist.

In order to prevent the reader from coming to such a conclusion, Hockney

feels obliged to say: "It is worth repeating here, I think, that optics don't make marks—they only produce an image, a look, a means of measurement."

### The Real Power of Art

Although Hockney's book sharpens our mind and teaches our eyes to look not only at "what" we see, but also to look at "how it was done," we have to emphasize that there exist much more important forgotten and lost secrets of art, far distant from the insane competition between handmade and technical representations of our vision.

The making of art today is not defined by technical problems of representation, but by the realm of generating powerful metaphorical paradoxes and ideas, capable of uplifting our species into everlasting beauty. That challenge goes far beyond the practical obsession of a simplistic Aristotelian want of "mimesis" (imitation of nature).

*Karel Vereycken, an artist, works with the LaRouche political movement, based in Paris.*

### Notes

1. Karel Vereycken and Philippe Messer, "A Gaze from the Beyond: The Extraordinary Faiyûm Portraits," *Fidelio*, Summer 1999, p. 83.

dered the 'halo' effect of out-of-focus highlights, seen here on the basket, the bread, the tankard and the jug, unless he had seen it."

## The Camera Obscura or Dark Room

Mostly known by the studies of Leonardo da Vinci, the *camera obscura* is a natural phenomenon, and has a long history. In its simplest form, it is nothing more than a small hole through which light passes from a sunlit garden into a dark room, projecting an inverted image onto the wall opposite the hole. The size of the hole will affect the sharpness of the image.

Aristotle wrote about the *camera obscura* in the 4th Century B.C., at about the same time as philosophers of China were recording their observations of images of pagodas, projected through gaps in window blinds. Early observations appear also in the Arab world, notably in the writings of Alhazan (Ibn al-Haitham 985-1038). But in 1086, the Chinese scholar Shen Kua writes beautifully in "Meng Chhi Pi Than":

"When a bird flies in the air, its shadow moves along the ground in

the same direction. But if its image is collected (like a belt being tightened) through a small hole in a window, then the shadow moves in the direction opposite to that of the bird. The bird moves to the east while the shadow moves to the west, and vice versa.

"Take another example. The image of a pagoda, passing through the hole or small window, is inverted after being 'collected.' This is the same principle as the burning mirror. Such a mirror has a concave surface, and reflects a finger to give an upright image if the object is very near, but if the finger moves farther away, it reaches a point where the image appears inverted. . . . Are not human beings also rather like this? There are few people whose thinking is not restricted in some way. How often they misunderstand everything and think that true benefit is harmful, and that right is wrong. In more serious cases

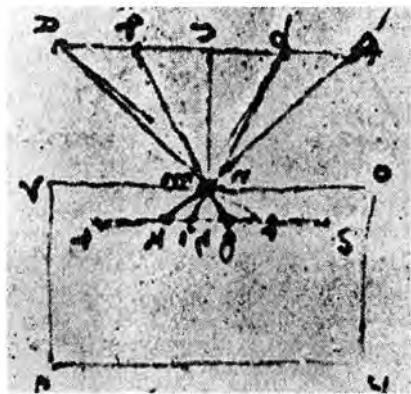

### LEONARDO'S CAMERA OBSCURA

*One of Leonardo's many drawings of his experiments with the camera obscura. The objects at top are illuminated and their images are reflected through a pinhole into a darkened chamber. Their images appear there upside down and transposed right to left.*

they take the subjective for the objective, and vice versa. If such fixed ideas are not got rid of, it is really difficult to avoid seeing things upside down."

# How the Atomic Space Ship Bit the Dust

by Marsha Freeman

---

## Project Orion

by George Dyson  
New York: Henry Holt, 2002  
Hardcover, 345 pages, \$26.00

---

Imagine yourself standing on line to board a spacecraft that was going to take you on the most fabulous scientific journey of your life. The 12-story high vehicle, powered by pulses produced by nuclear fission explosions, would comfortably accommodate the waiting 50 crew members and passengers.

You would compare in your mind the imminent start of your year-long round-trip exploration mission to Mars, to that of the Apollo astronauts in 1969. The mighty Saturn V weighed nearly 6.5 million pounds. Your nuclear-powered Orion ship weighs 4,000 tons, or 8 million pounds.

But the dramatic difference is not in the ship's size, but its power. To take its 35,000 *pounds* of payload to the surface of the Moon, the Saturn V, powered by chemical propulsion, needed 600 times more mass to get there than what it could bring home, 90 percent of the mass at launch being fuel. Your 4,000-ton ship is carrying 800 *tons*, or more than 1 million pounds, of payload, including the crew and passengers, all of the supplies they will need for the excur-

*In 1960, Ted Taylor showed Wernher von Braun a film of a test of a model of Orion. He remarked that it must have reminded von Braun of the 1930s, when he conducted amateur rocket tests in the German Society for Space Travel. This artist's rendition of an Orion nuclear-pulsed spacecraft (upper right), which appears in George Dyson's book, bears a striking resemblance to the art work created by the German space pioneers as early as the 1920s.*

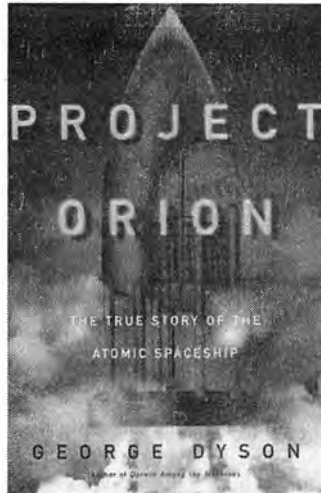

sion, and their scientific equipment. Nearly one fourth of the ship's initial weight is useful and necessary crew and cargo.

As you anxiously wait to board, other nuclear-powered ships are preparing nearby for two-year round trips to the moons of Saturn, where they will refuel by collecting the water ice on the satellites of the ringed planet. The age of the manned exploration of the entire Solar System is now open.

George Dyson describes in *Project Orion* how this was the dream of a handful of physicists who had worked

on the Manhattan Project during World War II. In the late 1950s, they wanted to apply what they had learned about atom bombs to a space propulsion system that would open travel to the stars to mankind.

### An Important Omission

But the aim of the project was not realized. The real reason is not discussed in the book, and this is a serious shortcoming, for until it is understood, it is unlikely we will get back to an ambitious space program. Project Orion developed in the context of the Cold War. The postwar political atmosphere had been deliberately poisoned against the civilian use of nuclear energy by the Utopian policy promoted by Bertrand Russell and H.G. Wells. The plan was to force national governments to surrender their sovereignty out of fear of an ultimate weapon of destruction, and then implement a world order of population control and zero economic growth, much as the IMF and World Bank have done. The goal was the elimination of the U.S. model, the American System and American intellectual tradition which turned an undeveloped nation into an industrial giant in the 19th Century.

The Utopians had forced the unnecessary dropping of two atomic bombs

on a Japan that was known to be ready to surrender—against the advice of leading military figures, like Generals Dwight Eisenhower and Douglas MacArthur. Public reaction to this horror was then manipulated to try to force through a policy of nuclear technology control and “arms control” agreements between the United States and the Soviet Union. After the 1963 Atmospheric Test Ban Treaty, which made even the civilian appli-



cation of nuclear explosions nearly impossible, came the effort to eliminate the idea of progress by introduction of New Age cults and anti-scientific irrationalism into the United States.

In fact, another book could be written, telling the story of how two of the Orioneers became involved with the Utopians: Theodore B. Taylor later became a leading opponent of any form of nuclear energy. Freeman Dyson, the author's father, was a leading member of Bertrand Russell's Pugwash operation, and in 1963, he joined the U.S. State Department team negotiating the Test Ban Treaty that would help kill Project Orion. He later justified this with the Wellsian argument that, "It is perhaps wise that radical advances in technology, which may be used for both good and evil purposes, be delayed until the human species is better organized to cope with them."<sup>1</sup>

#### 'Saturn by 1970'

That Project Orion was a highly ambitious program, there is no doubt. The scientific problems to be solved included how to detonate a fission bomb in space, couple the energy to a propellant, and shape the charge to produce energy directed toward the ship. The physicists believed that these had largely been solved by the time Project Orion was cancelled in 1965.

What remained was a set of formidable engineering tasks: to develop a system to release small fission bombs at intervals of, at most, a few seconds, to be able transfer the energy produced by the plasma shock wave from the explosion gently and safely to a manned spacecraft, and to ensure the survivability of the craft and crew if a bomb failed to detonate.

"Saturn by 1970" was the slogan of the optimistic Orioneers. But their dream machine was a hybrid of strictly military, and classified, atom bomb research and development, with a purely civilian, scientific application. The scientists were in a constant battle to find support for their atomic-powered project.

The military services could find no mission for such a gargantuan manned spacecraft, especially because it was before they had orbited even small

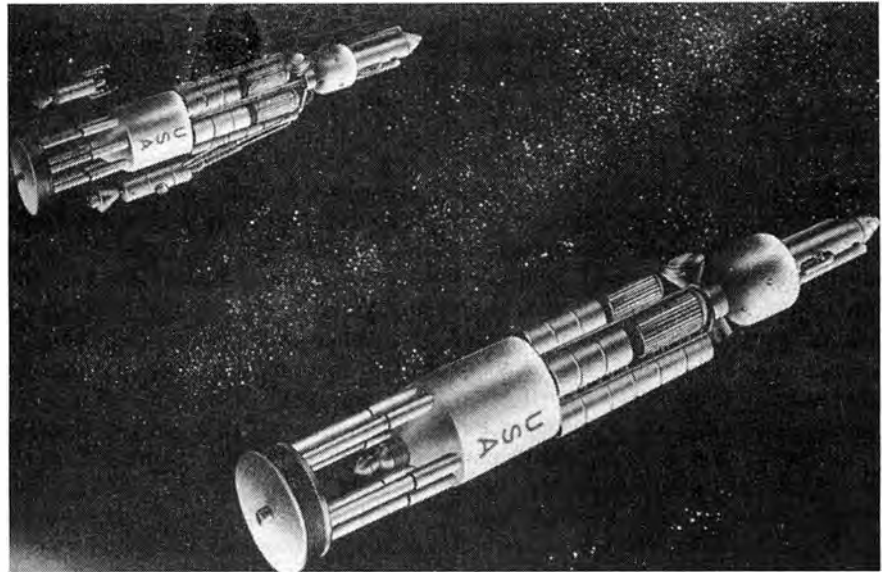

*This undated drawing of a fleet of Orion spacecraft on their way to Mars, shows the disk-like pusher plate at the rear, the bomb-delivery system pointed downward toward it, the shock absorbers connecting the pusher plate to the rest of the craft, the bomb storage module (with "USA" written on it), cargo storage, and the crew quarters in the rounded module near the top. Nearby is a "space taxi" to make transfers between ships. Orion would not enter the Earth's atmosphere upon return, but remain in orbit to be refitted and refueled.*

unmanned satellites. And when the civilian National Aeronautics and Space Administration (NASA) became interested in Orion, all of its energy had to be focussed on the presidentially mandated, near-term Apollo program. NASA could not justify spending large sums from its already shrinking budget for such long-term, speculative programs.

Although Project Orion never created the nuclear-powered spaceship, the legacy of Project Orion is very much alive today, in both the military and civilian arenas. Dyson reports that the theoretical research carried out to focus explosions for propulsion, for example, is being applied today in research on directed energy weapons.

#### Nuclear Power in Space

NASA has begun a small-scale research and development program to explore advanced and revolutionary technologies, to finally move beyond chemical propulsion for long-range spacecraft missions. Data from Project Orion are informing the current efforts.

The possibility of using nuclear fission to propel spacecraft had been pre-

liminarily investigated more than 10 years before Project Orion, by space visionary Krafft Ehrlicke, at the German rocket research facility in Peenemunde. In 1942, he was asked to investigate the application of fission energy as a method to propel a spaceship, which, "while certainly not needed for Earth-Moon travel, is necessary for interplanetary voyages," Ehrlicke stated.<sup>2</sup>

In an article published in 1953, in the *Journal* of the American Rocket Society, Ehrlicke compared the capabilities and characteristics of various combinations of fuels and propellants, and concluded that for missions beyond Earth orbit, nuclear-heated hydrogen propellant would be superior to any chemical fuel combination.

In the 1940s, some of the men working on America's atomic bomb project at Los Alamos Laboratory were also investigating nuclear propulsion for rockets and missiles. As George Dyson reports in his comprehensive account, Los Alamos physicist Stanislaw Ulam recalls that "the idea of nuclear propulsion of space vehicles was born as soon as nuclear energy became a

reality." As soon as the war ended, designs were under development to create controlled fission reactions in power plants to produce commercial electricity. Why not use the concentrated energy of this new source of power to propel a missile or a spaceship?

Ulam recognized that the limiting factor for the power that could be created in a nuclear-reactor-driven spacecraft would be constraints on the materials used to contain the heat in the reactor to prevent it from being vaporized. As a result, the rating of a nuclear-reactor-driven propulsion system would be only twice that of chemical fuels, even though fission fuel contains more than a million times as much energy per unit mass.

Ulam's solution was to eliminate the reactor altogether and move the nuclear reaction *outside* the spacecraft. In this way, Orioneer Freeman Dyson explains, there would be virtually no limit to the power that could be produced, because the explosion was outside the spacecraft and did not have to be contained. There would be no limit on the temperature created by the fission reaction, because the explosion debris would be in contact with the ship only very briefly.<sup>1</sup> Unlimited power and temperature would create

the most highly efficient space propulsion system that anyone could imagine.

In 1955, Ulam and Cornelius Everett produced a report, *On a Method of Propulsion of Projectiles by Means of External Nuclear Explosions* at Los Alamos. Three years later, the proposal for Project Orion was born. Former Los Alamos bomb designer Frederic de Hoffmann was recruited by General Dynamics in San Diego, California, in 1955, to bring the defense giant into the new field of nuclear energy. De Hoffmann was given \$10 million to start a company called General Atomic.

In 1958, de Hoffmann enthusiastically adopted physicist Ted Taylor's practical application of the Ulam-Everett report, in the form of Project Orion, into the work of General Atomic. According to George Dyson, De Hoffmann persuaded Freeman Dyson, a theoretical physicist, to come to San Diego to work on Orion during the 1958-1959 academic year.

What the Orionees envisioned was truly breathtaking. The 4,000 ton craft would be powered by up to 2,600 nuclear bombs ranging from .15 to 5 kilotons. Eight hundred small bombs would be needed for the craft to reach a 300-mile Earth orbit, and the rest

would be used for the interplanetary trip. Each bomb would weigh about half a ton, and one would be fired every half second.

Orion would be able to bring 1,600 tons of payload to Low Earth Orbit. This was being proposed at a time when the only U.S. experience in space flight had been the orbit of the 30-pound Explorer satellite! Orion could deliver 1,200 tons to land on the Moon (compared to about 35,000 pounds for the Saturn Apollo), or a payload of 800 tons to soft landing on Mars.

With the capabilities of the nuclear-pulsed space ship, explorers could go virtually anywhere.

### From Explosion to Propulsion

Ted Taylor and a small group of some of the nation's top nuclear weapons specialists set about designing small nuclear bombs that could be applied to space-based propulsion. In his account, George Dyson makes use of what weapons-related information has been declassified, but many of the details for the bomb-related Orion propulsion system are still unavailable to the public. At the end of the project, the scientists were confident they could produce the required explosions in space.

One of the most interesting challenges was to shape the nuclear charge so the plasmized propellant did not go flying off into all directions in space, but became focussed toward a pusher plate attached to the spacecraft. Freeman Dyson worked on the problem of how to relate the shape and density of the initial object that gets vaporized (the propellant), to the shape and density of the resulting cloud of gas. He determined that "something originally in the shape of a pancake expands into the shape of a cigar," according to George Dyson. The thinner the pancake, the narrower the jet of plasma. Freeman Dyson calculated that a jet collimated within 20 degrees would work. The details are still classified.

The equally, if not more, formidable task was to couple this focussed energy to a spacecraft. The propulsion system would start with violent explosions yet have to gently push the ship, at about a 2 gravity rate of acceleration, in a near steady state, in order to make

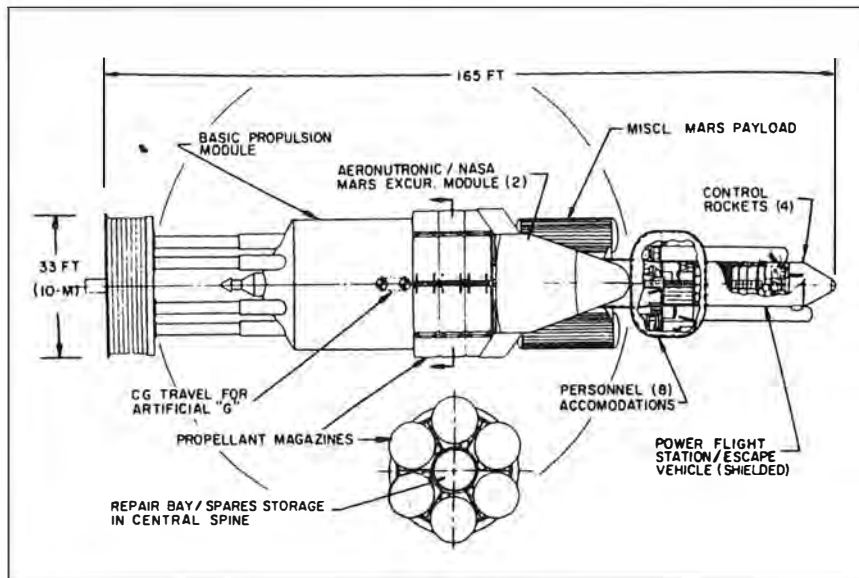

During 1963-1964, General Atomic designed a smaller, Orion-derived Mars exploration vehicle for NASA. Weighing 100 tons, it would be launched to Earth orbit on a Saturn V rocket. Its 80-ton payload would include two Mars Excursion Modules, and supplies for eight people and their 450-day trip.



the trip comfortable for the human cargo.

The scientists proposed that a steel or aluminum pusher plate, attached to the space vehicle, be positioned between 110 to 200 feet from the exploding bomb. This massive structure would be between 120 to 135 feet in diameter, depending upon the size of the ship, and account for one quarter of the ships total weight, or about 1,000 tons.

The pusher plate would absorb the burst of energy from the shock wave created when the bomb turned the propellant, which was combined with the bomb into a single pulse unit, into a high-energy plasma. Through experiments using conventional explosives, the scientists found they could coat the pusher plate with an "anti-ablation" grease, to avoid damaging the metal plate.

But how do you transfer these millisecond bursts of energy to a manned vehicle? Orion's developers decided on a system of shock absorbers that would store the pulse of energy delivered to the pusher plate, and release it gradually to the vehicle. George Dyson describes in detail the evolution of various concepts for these shock absorbers, and the doubts about whether or not this problem had been solved by the time the project was ended.

After a substantial amount of theoretical work had been done, the scientists were ready to take a small-scale model of their invention out for field tests. As physicist Bud Pyatt (who Dyson reports is "still engaged today in weapons-effects work descended from Project Orion") stated: "Nine times out of ten we got about three-quarters of the way with computing, but we always had rude surprises when we did experiments."

In 1958 and 1959, a series of experiments were done with 1- and 3-foot diameter models, using high-energy chemical explosives, not nuclear bombs. Freeman Dyson stated, "The purpose of the flying models was to demonstrate that a vehicle possessing, in rudimentary form, the same engineering components as a full-scale ship, including pusher plate and shock absorbers and ejector system, could be made to function correctly." Today, the 1-meter

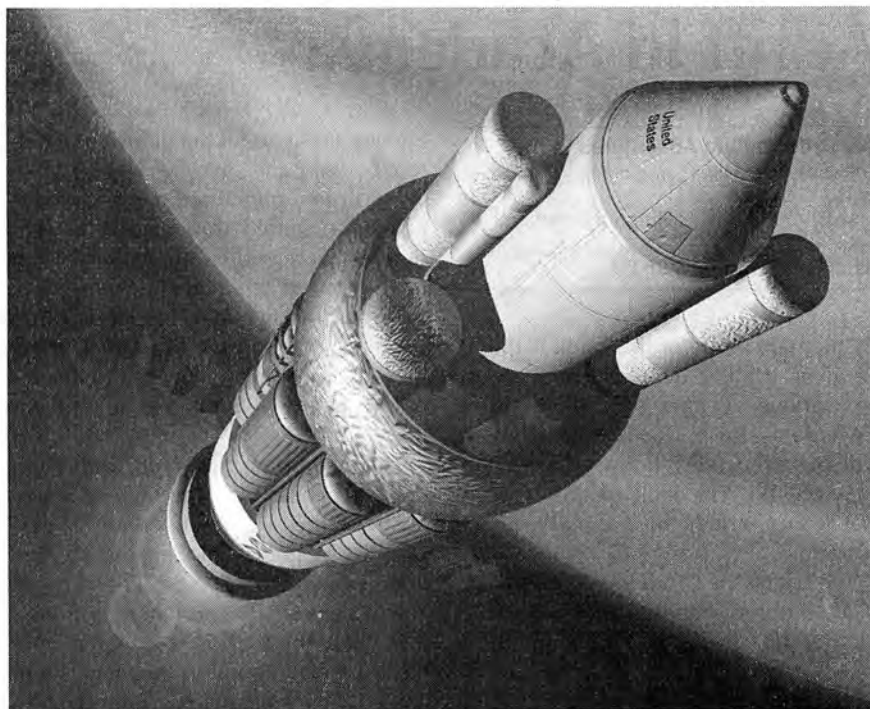

NASA

*Today NASA is once again studying revolutionary new propulsion technologies. This artist's drawing of an Orion spaceship, with the nuclear fission explosion and plasma cloud behind the pusher plate, was created at the Marshall Space Flight Center, in 1999.*

diameter test model is on display at the Smithsonian's National Air & Space Museum.

But the Orioneers knew that the real proof-of-principle experiments would have to include the nuclear-propulsion system.

#### **The End of Orion**

The signing of the Atmospheric Nuclear Test Ban Treaty in 1963 was the death knell for Project Orion, by outlawing any radioactive fallout from nuclear explosions in the atmosphere. This meant that scale models could not be tested on the ground, and that the original idea of using fission pulses for take off from a launch site would be out of the question.

In 1959, a still-classified report, *Radioactive Fallout from Bomb-Propelled Spaceships*, was completed, George Dyson reports. In fact, from his description, it relied upon an unscientific, simple linear extrapolation from the physiological effect of radiation in other cases, to this one. The study nonetheless found that, hypothetically, using the linear no-threshold extrapolation, 10 people in the entire world might die

from cancer as a result of increased exposure to radiation from each mission of Orion.

But the Orion scientists recognized that the fallout question was a political, not scientific, one. As the small amount of funding for Orion that had been provided by the Defense Department became less and less certain, the scientists were able to interest Wernher von Braun in their atomic-powered spaceship. Designs were created for smaller Orions, to be launched into Earth orbit on von Braun's Saturn B rockets. Their nuclear fission engines would not be started until they were on their interplanetary way. But the die had already been cast.

The end of Project Orion in 1965 left unanswered the question: could a nuclear-bomb-powered spaceship be developed? We do not now know. But, hopefully, we will soon find out.

#### **Notes**

1. Freeman Dyson, 1965. "Death of a Project." *Science*, Vol. 149, No. 3680, (July 9).
2. Marsha Freeman, 1993. *How We Got to the Moon: The Story of the German Space Pioneers*, Washington, D.C.: 21st Century Science Associates, pp. 106-107.

# Adrift in Academia

## Sea Drift: Rafting Adventures in the Wake of Kon-Tiki

by P.J. Capelotti  
New Brunswick, N.J.: Rutgers University Press, 2001  
Hardcover, 295 pp., \$ 26.00

The main virtue of this book is that it gives a fairly detailed summary of the various voyages of explorer Thor Heyerdahl—Ra I, Ra II, the Tigris—which are much less known than that of the Kon-Tiki. The fault of this book is that it was written by a fantasy-ridden academic.

The beauty of Thor Heyerdahl's work is its hubris, defying the academic "authorities"—who themselves are terrified of making waves in their own small pond. Heyerdahl built a log raft of a kind that had not been built within living memory, and drift/sailed 4,300 miles in 101 days across the Pacific (which is anything but pacific), to test

an hypothesis about the diffusion of culture by man!

Heyerdahl punctured more than one academic stuffed shirt during his lifetime of work, but even he might not have realized the academic's real job: to *shrink the heads of the students, to the size of a pin, just like theirs*. For if they perform this job well, the academic's chair will probably be safe for life.

The author of *Sea Drift*, himself a denizen of academia, has little inkling of this, which is why he describes his purpose as giving us "an interesting islet upon which to dwell for a time."

Not surprisingly, the other "drift voyages" described in this book, range from the marginally useful to the vicious and absurd. One evil sociologist brought an odd number of men and women aboard a raft—though perhaps this should not be classified as a "drift voyage" because they tried to screw their way across the

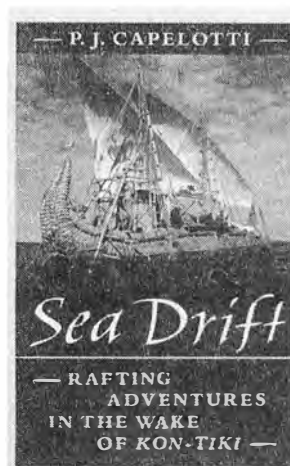

Atlantic. One weirdo convinced his wife that he would communicate with her telepathically while he was out alone on the raft in the middle of the Pacific. (It might have worked, but he turned his head off.)

So, you can read the sections on Heyerdahl, and skim the other parts. Better yet, get Heyerdahl's books and read them instead.

—Richard Sanders

## CHALLENGES OF HUMAN SPACE EXPLORATION

SPRINGER PRAXIS SERIES IN ASTRONOMY AND SPACE SCIENCE

by Marsha Freeman

Associate Editor, *21st Century Science & Technology*

The real story of the accomplishments of the United States and Russia aboard the Mir space station.  
Foreword by Dr. Michael DeBakey.

300 pages, illustrated

**SPECIAL DISCOUNT FOR \$30**  
21st Century readers

(list price \$45)

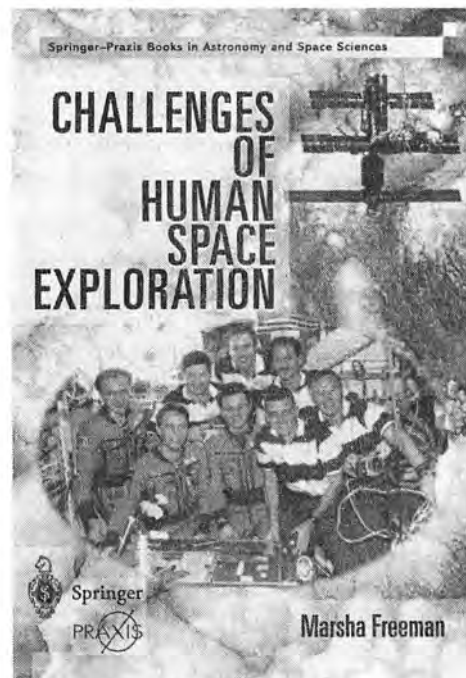

Mail check or money order (U.S. currency only) to:

**21st Century Space Books** P.O. Box 1951, Dept. T, Leesburg, VA 20177

# Have You Missed Any 21st Century? 21<sup>st</sup> CENTURY SCIENCE & TECHNOLOGY

Back issues are available at \$5 each (\$8 foreign) from our website or by mail. For a more detailed listing of contents, and a complete list of back issues available, check the magazine website: [www.21stcenturysciencetech.com](http://www.21stcenturysciencetech.com).

## Spring 2002

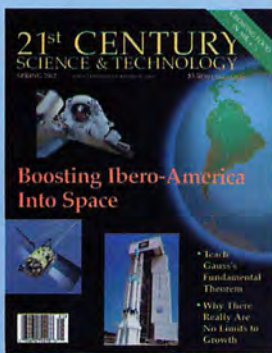

- Alexander von Humboldt: A Republican Scientist in the Tradition of Franklin  
*Timothy Rush*
- Ibero-America Needs a Space Agency!  
*Marsha Freeman*
- Gauss's Declaration of Independence: The Fundamental Theorem of Algebra  
*Bruce Director*

## Winter 2001-2002



- Pedro Paulet: Peruvian Space and Rocket Pioneer  
*Sara Madueño Paulet de Vasquez*
- Pitcairn Island Petroglyph Deciphered  
*Ross Perfect*

- The Case for Adult Stem Cell Research  
*Wolfgang Lillge, M.D.*

## Fall 2001



- Why You Don't Believe Fermat's Principle  
*Laurence Hecht*
- The Scientific Renaissance of the Medieval Cathedrals  
*Philippe Messer*
- The Paradoxes of Moving Electricity  
*Rémi Saumont*

## Summer 2001



- Biography of Barry Fell, Part 2  
*Julian Fell*

- Bring Science Back to Life—Vernadsky's Method  
*Jonathan Tennenbaum, Laurence Hecht, Wolfgang Lillge, Dino De Paoli, Lyndon H. LaRouche, Jr.*
- Where Do We Stand on Cold Fusion?  
*Edmund Storms*

## Spring 2001



- The New Nuclear Power  
*Marjorie Mazel Hecht*
- The Natural Science of Goethe  
*Ralf Schauerhammer*
- Anti-Gravity: Myth or Reality  
*Rémi Saumont*

## Winter 2000- 2001



- On the Difference between Living and Nonliving Bodies in the Biosphere (1938)  
*Vladimir I. Vernadsky*

- Magnettrain: High-Speed Rail For the 21st Century  
*Laurence Hecht*
- Terraforming Mars to Create a New Earth  
*Marsha Freeman*

## Fall 2000

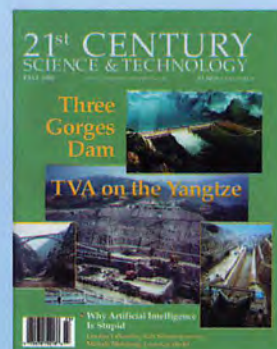

- WHY ARTIFICIAL INTELLIGENCE IS STUPID:
- Where Do We Attach the Head?  
*Lyndon H. LaRouche, Jr.*
  - The Artificial Reputation of John von Neumann's Intelligence  
*Ralf Schauerhammer*
- Programmed to Kill: Video Games, Drugs, and the 'New Violence'  
*Michele Steinberg*
  - Three Gorges Dam: The TVA on the Yangtze River  
*William C. Jones and Marsha Freeman*

To order, send dates of back issues requested and a check or money order (U.S. currency only) for \$5 for each issue ordered (\$8 foreign), to

**21st Century** P.O. Box 16285, Washington, D.C. 20041

Also available by credit card on the website: [www.21stcenturysciencetech.com](http://www.21stcenturysciencetech.com)

## In This Issue:

### 9,000-YEAR-OLD CITIES FOUND OFF INDIA'S COAST

Forty meters below the surface of the Gulf of Cambay, off the northwest coast of India, lie the remains of what appear to be two large ancient cities. India's National Institute of Ocean Technology, which made the discovery in 2001, has dated some artifacts from the site to 8,500 to 9,500 years before the present. If further exploration verifies the initial findings, it will push back the age of the first urban centers by more than 3,000 years, and revolutionize our concept of ancient history.



© 2002 Santha Faiia

*An underwater view of the ruins at Mahabalipuram, India.*

### ATOMIC EXPLOSIONS TO PROPEL SPACE SHIPS

Project Orion—using tiny atomic bombs to propel space ships—was the dream of a handful of physicists who worked on the Manhattan Project in World War II. The project was stopped in mid-development in 1965. Marsha Freeman reviews George Dyson's history of Project Orion.



Laurence Hecht

*A recent NASA rendering of a Project Orion space vehicle. Small nuclear pulse units, discharged from the rear of the vehicle, would be converted into a continuous propulsive force.*

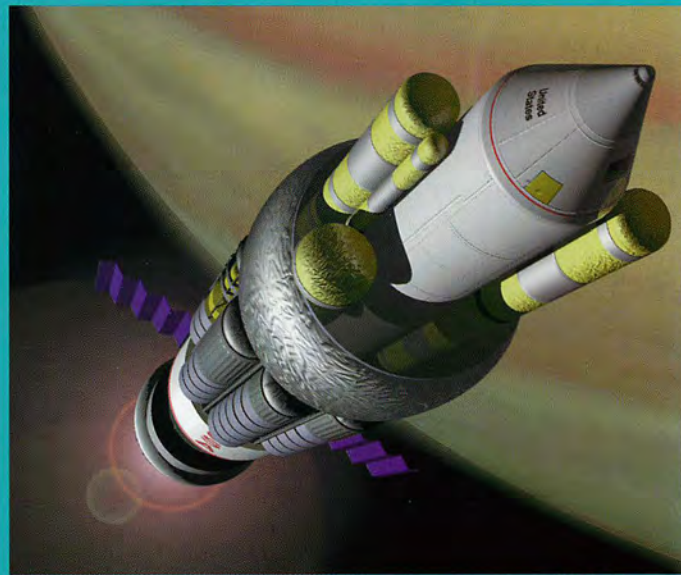

NASA

### WHERE THE ABSOLUTE SYSTEM OF UNITS CAME FROM

An expert in Weber's electrodynamics, and biographers of Carl Friedrich Gauss and Wilhelm Weber, tell how their 1829-1832 work in magnetism revolutionized physics.

*The electrodynamicometer which Gauss and Weber used to prove the validity of Ampère's law for the force between current elements.*