

ANOTHER GLOBAL WARMING FRAUD EXPOSED

Ice Core Data Show No Carbon Dioxide Increase

Read Dr. Jaworowski's most recent article, "CO₂: The Greatest Scientific Scandal of the Century" at <http://www.21stcenturysciencetech.com>

by Zbigniew Jaworowski, Ph.D.

Attempts to support the global warming thesis with analyses of the carbon dioxide content of air bubbles in glacial ice samples, are based on fudged data and ignorance of the physical processes of glacial ice formation.

EDITOR'S NOTE

When climate science was not driven by ideology, it was generally assumed that long-term astronomical cycles—those measured in tens or hundreds of thousands of years—were the way in which climate had to be situated. The long 100,000-year cycles of Ice Ages are determined by the periodicities in the eccentricity, tilt, and precession of the Earth's orbit; in between Ice Ages, there are roughly 10,000-year periods known as interglacials, when relatively milder climates prevail. Right now, the Earth is at the tail end of an interglacial and probably already entering a period of glacial advance.

The Ice Ages of the past and the coming Ice Age have a timetable of their own, quite independent of man's industrial output of carbon dioxide. No scientist who knew these astronomical cycles could possibly be trapped into worrying about the ups and downs of local or global temperatures in time spans of years or even decades, or seriously be concerned

with short-term computer modelling and associated scare stories about global warming.

The times have changed, and so has environmental ideology—but the long-range climate cycles have not changed. This means, that based on the last several million years of history, the world is inexorably moving into another Ice Age, no matter how much propaganda is generated about global warming. The global warming hypothesis and the many research artifacts it has generated can be dissected and disproved one by one; but the fact remains that the overall question of climate must be situated in a long view of history, not the short term.

This article examines one of the main pillars of the global warming thesis: the assertion that ice core data—analyses of gas bubbles trapped in glacial ice—prove that atmospheric carbon dioxide, CO₂, has increased since the pre-industrial era as a result of fossil-fuel burning and other human activities.

From its very beginning, the hypothesis on anthropogenic greenhouse warming was tainted with a biased selection of data, ad hoc assumptions that were not verified experimentally, and one-sided interpretations. Such symptoms of affliction, which Irving Langmuir called “pathological science,”¹ are evident in the publications of G.S. Callendar, who truly can be regarded as the father of the modern “man-made climatic warming” hypothesis. In 1938, Callendar revived Svante Arrhenius’s idea of man-made climatic warming, now 100 years old.² Callendar claimed that because of fossil fuel burning, the average atmospheric concentration of CO₂ had increased from the 19th century value of 274 parts per million volume (ppmv) to 325 ppmv in 1935, that is, by 18.6 percent; and that between 1880 and 1935, this caused an increase in the global surface temperature of 0.33°C.³⁻⁵ However, the *measured* 19th century CO₂ concentrations in the atmosphere ranged from about 250 to 550 ppmv (Figure 1), and the average concentration estimated from these values was 335 ppmv.⁶

A nonsignificant decreasing trend of values in Figure 1, between 1860 and 1900, when CO₂ emissions from fossil fuel burning increased from 91.5 to 485.6 million tons of carbon was similar to a decrease in global surface air temperature in this period.⁷ This may reflect lower CO₂ degassing from colder oceans, the result of natural climatic fluctuation.⁸

To reach the low 19th century CO₂ concentration, the cornerstone of his hypothesis, Callendar used a biased selection method. From a set of 26 19th century averages, Callendar rejected 16 that were higher than his assumed low global average, and 2 that were lower. Callendar’s paper of 1938, presented at a meeting of the Royal Meteorological Society, was criticized by its members, who asked a dozen fundamental questions (for example, the validity of the estimate of CO₂ average concentrations, the basics of the carbon cycle, and the balance between radiation and atmospheric temperature distribution), which, after half a century, have remained unanswered and are still the subject of ardent discussions (for example, see Reference 9).

Because of uncertainties in 19th century air measurements, studies of greenhouse gases in glacier ice are often regarded—incorrectly—as the most reliable estimates of CO₂, CH₄ (methane), and N₂O (nitrous oxide) concentrations in the pre-industrial atmosphere. The results of ice core analyses are supposed to be “the only possible validation of models that were set up to describe future climatic changes caused by anthropogenic emissions.”¹⁰ On the basis of these analyses, the Intergovernmental Panel on Climate Change¹¹ declared that the pre-industrial concentration of CO₂ in the atmosphere was 26 percent lower than the current level. The IPCC also declared that the pre-industrial concentration of N₂O was 19 percent lower, and that CH₄ was 215 percent lower than current levels. However, no study has yet demonstrated that the content of greenhouse trace gases in old ice,

Zbigniew Jaworowski, M.D., Ph.D., and D.Sc., a multidisciplinary scientist, is a professor at the Central Laboratory for Radiological Protection, Warsaw, Poland. He has served as the chairman of the United Nations Scientific Committee on the Effects of Atomic Radiation, and has studied glacier ice samples from around the world, analyzing traces of heavy metals and radionuclides.

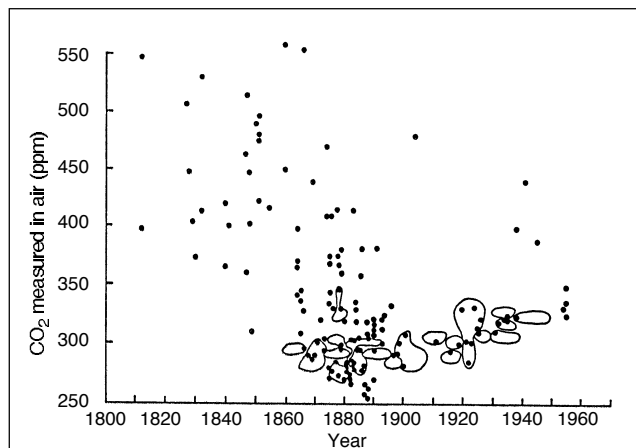

Figure 1
AVERAGE ATMOSPHERIC CO₂ CONCENTRATIONS MEASURED IN THE 19TH AND 20TH CENTURIES

The values that G.S. Callendar chose to use are shown encircled. He rejected both higher and lower values, to arrive at a figure that backed up his hypothesis.

Source: Adapted from S. Fonselius, et al., 1956. *Tellus*, Vol. 8, p. 176

or even in the interstitial air from recent snow, represents the atmospheric composition.

Ice Core Data Unreliable

The ice core data from various polar sites are not consistent with each another, and there is a discrepancy between these data and geological climatic evidence.¹² One such example is the discrepancy between the classic Antarctic Byrd and Vostok ice cores, where an important decrease in the CO₂ content in the air bubbles occurred at the same depth of about 500 meters, but at which the ice age differed by about 16,000 years. In an approximately 14,000-year-old part of the Byrd core, a drop in the CO₂ concentration of 50 ppmv was observed, but in similarly old ice from the Vostok core, an increase of 60 ppmv was found. In about ~6,000-year-old ice from Camp Century, Greenland, the CO₂ concentration in air bubbles was 420 ppmv, but it was 270 ppmv in similarly old ice from Byrd, Antarctica.

H. Oeschger, et al. made an ad hoc attempt to explain some of these discrepancies as (1) “a process which has not yet been identified,” (2) wrong modelling, and (3) “not overlapping time intervals,” but these explained nothing.¹³ The failure to resolve the notorious problem of why about 30 percent of man-made CO₂ is missing in the global carbon cycle, based on CO₂ ice core measurements, suggests a systematic bias in ice core data.¹⁴ It is not possible to explain the ice core CO₂ record in terms of a system with time-invariant processes perturbed by a combination of fossil fuel carbon release, CO₂-enhanced biotic growth, and deforestation.¹⁵

Dating of such important climatic events as the termination of the Younger Dryas period based on dendrochronology (examination of tree ring growth) and lake sediments, differs from recent ice core data from Greenland by up to about 900 years.¹⁶ The short-term peaks of δ¹⁸O in the ice sheets have been ascribed to annual summer/winter layering of snow

Figure 2
PROCESSES OCCURRING IN
POLAR ICE SHEETS

Absorption of solar radiation at low temperature partly volatilizes and melts the snowflakes. Snow is metamorphosed to firn. The thermal gradient and gravitational compression of snow cause upward movement of gas. Some air escapes from firn back to the atmosphere, and H₂O vapor condenses near the wind-cooled surface, starting formation of the ice crusts. Depth hoar forms as a result of loss of material by sublimation. Meltwater seeps down and collects over impermeable layers. The firn density gradually increases with depth, and at 0.83 g/cm³, firn changes into solid ice in which all pores are occluded, forming the primary air bubbles. Between a depth of 900 to 1,200 m, air bubbles disappear. Liquid water is contained in quasi-infinite network of capillary veins and films between the ice crystals. After relaxation of the load pressure, secondary gas cavities are formed in the cracked ice cores contaminated with the drilling fluid.

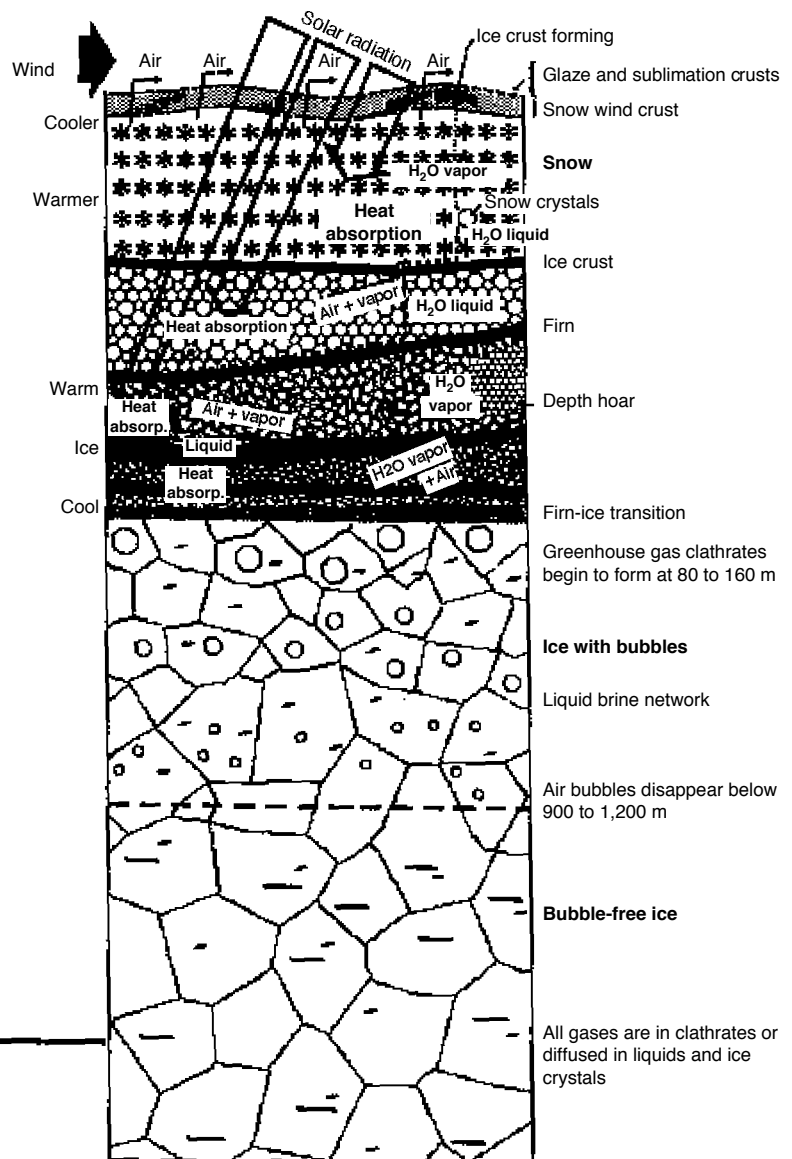

formed at higher and lower air temperatures. These peaks have been used for dating the glacier ice, assuming that the sample increments of ice cores represent the original mean isotopic composition of precipitation, and that the increments are in a steady-state closed system.^{17,18}

Experimental evidence, however, suggests that this assumption is not valid, because of dramatic metamorphosis of snow and ice in the ice sheets as a result of changing temperature and pressure. At very cold Antarctic sites, the temperature gradients were found to reach 500°C/m, because of subsurface absorption of Sun radiation.¹⁹ Radiational subsurface melting is common in Antarctica at locations with summer tempera-

tures below -20°C, leading to formation of ponds of liquid water, at a depth of about 1 m below the surface.¹² Other mechanisms are responsible for the existence of liquid water deep in the cold Antarctic ice, which leads to the presence of vast sub-sheet lakes of liquid water, covering an area of about 8,000 square kilometers in inland eastern Antarctica and near Vostok Station, at near basal temperatures of -4 to -26.2°C.¹² The sub-surface recrystallization, sublimation, and formation of liquid water and vapor disturb the original isotopic composition of snow and ice (Figure 2).

Important isotopic changes were found experimentally in

firn (partially compacted granular snow that forms the glacier surface) exposed to even 10 times lower thermal gradients.¹⁹ Such changes, which may occur several times in a year, reflecting sunny and overcast periods, would lead to false age estimates of ice. It is not possible to synchronize the events in the Northern and Southern Hemispheres, such as, for example, CO₂ concentrations in Antarctic and Greenland ice. This is, in part the result of ascribing short-term stable isotope peaks of hydrogen and oxygen to annual summer/winter layering of ice and using them for dating.¹⁷

New light was shed on the validity of the dating of recent ice strata when six U.S. Lightning fighter planes and two B 17 Flying Fortresses from World War II were found buried in 1942 ice, about 200 km south from a classic Greenland site at Dye 3, where they had made an emergency landing. The planes were found 47 years later at a depth of 78 m, and not at the 12-m depth that had been estimated by glaciologists using oxygen isotope dating.²⁰

In the air from firn and ice at Summit, Greenland, deposited during the past ~200 years, the CO₂ concentration ranged from 243.3 ppmv to 641.4 ppmv.²¹ Such a wide range reflects artifacts caused by sampling, or natural processes in the ice sheet, rather than the variations of CO₂ concentration in the atmosphere. Similar or greater range was observed in other studies of greenhouse gases in polar ice. (See reviews in References 12 and 22.)

Fudging the CO₂ Data

Until 1985, the published CO₂ readings from air bubbles in pre-industrial ice ranged from 160 to about 700 ppmv, and occasionally even up to 2,450 ppmv. After 1985, high readings disappeared from the publications! To fit such a wide range of results to the anthropogenic climatic warming theory, which was based on low pre-industrial CO₂ levels, three methods were used: (1) rejection of high readings from sets of pre-industrial samples, based on the credo: "The lowest CO₂ values best represent the CO₂ concentrations in the originally trapped ice";²³ (2) rejection of low readings from sets of 20th century samples; and (3) interpretation of the high readings from pre-industrial samples as representing the contemporary atmosphere rather than the pre-industrial one.

Publications on greenhouse gases in ice often exhibit similar symptoms to those of G.S. Callendar, cited above. But the most important deficiency of these studies is the ice matrix itself, which does not fulfill the absolutely essential closed-system criterion. This is because liquid water is present in ice even at very low temperatures, and because many chemical and physical processes occur, in situ, in ice sheets and in recovered ice cores. These factors, discussed in References 8, 12, 22, and 24-28, change the original composition of air entrapped in ice, making the ice core results unrepresentative of the original chemical composition of the ancient atmosphere.

Here are some typical examples of how the estimates of pre-industrial atmospheric levels of greenhouse gases were determined. These results were then taken as a basis for estimation of the man-made climatic warming.¹¹

- Neftel, et al. reported in 1982 rather high median CO₂ concentrations in the preindustrial ice core from Byrd, Antarctica, of about 330 and 415 ppmv, with maximum value reaching 500 ppmv.²³ However, in 1988, in the second publication

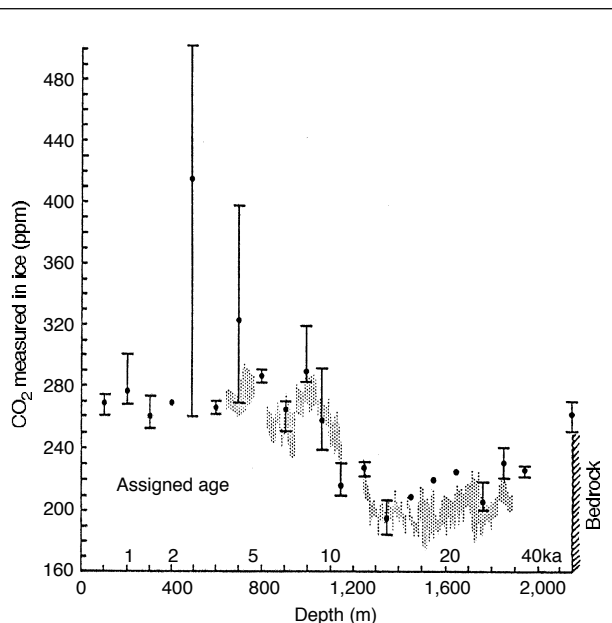

Figure 3
HOW SELECTION OF ICE CORE DATA
SKEWS RESULTS TO MATCH
THE GLOBAL WARMING THEORY

In presenting measurements of CO₂ concentrations in the pre-industrial ice core from Byrd Antarctica, Neftel, et al., in 1982 showed maximum values up to 500 ppmv (dots and bars). In 1988, the same authors published measurements for the same section of the Byrd ice core (gray areas), but left off the high readings published previously, reporting a highest concentration of 290 ppmv, in agreement with the global warming theory.

on the same core, Neftel et al. did not show these high readings; the highest concentration reported was 290 ppmv, in agreement with the global warming theory²⁹ (Figure 3).

- Pearman, et al. "on examination of the data," rejected 43 percent of the CO₂ readings from Law Dome, Antarctica core, 39 percent of the CH₄ readings, and 43 percent of the N₂O readings, because they were higher or lower than the assumed "correct" values.³⁰ Thus, they concluded a value of 281 ppmv CO₂ for the pre-industrial atmosphere, and increases from the year 1600 of 90 percent and 8 percent of CH₄ and N₂O, respectively.

- Leuenberger and Siegenthaler claimed that their data from a Greenland ice core demonstrate that the present level of N₂O in the atmosphere, 310 ppbv, is an effect of a recent 19 percent increase caused by industrial activity.³¹ To reach this conclusion, they rejected 27 percent of the samples with N₂O readings deemed to be "too high" for pre-industrial ice. After this "correction," the average pre-industrial atmospheric concentration of N₂O was declared to be 260 ppmv, although their value for ice from the year 1822 was 296.1 ppmv. Their results from a shallow Dye 3, Greenland core show a random N₂O distribution. Nevertheless, the authors formed an increasing temporal trend by rejecting the "incorrect" high readings.

- Etheridge, et al. claimed that their ice core results show a

pre-industrial N_2O concentration of 285 ppbv.³² This value was calculated after rejection of 44 percent of their measurements! From the remaining analyses, the high readings from 16th and 17th century ice (328.3 and 329.8 ppbv), which were higher than in the 20th century samples (285.7 and 322.9 ppmv), were again eliminated without explanation.

• Zardini, et al. rejected a low N_2O reading of 240 ppbv in the youngest part of an Antarctic core from the year 1919.³³ From the several-thousand-year-old part of the core, they did not reject an even lower value of 217 ppbv, but they eliminated the high values of 310, 354, 359, and 362 ppbv. After these “improvements,” Zardini, et al. concluded that the pre-industrial N_2O level in the atmosphere was 270 ppbv, and that in the present atmosphere N_2O increased “due to fossil fuel burning.”

Some False Assumptions

For climatic interpretation of the ice core data the following assumptions are used:

(1) The entrapment of air in the ice is essentially a mechanical process, which occurs with no fractionation of the gas components;³⁴ the original composition of trapped air is believed to be permanently preserved in the polar ice sheets and in the collected ice cores. This means that the ice, with its included air bubbles, should remain a closed system during tens or hundreds of thousands of years in the ice sheets, and that this system is not disturbed during the core drilling or its transportation to the laboratory and its storage.

(2) No liquid phase occurs in firn and ice at average annual air temperatures of $-24^{\circ}C$ or less.³⁵

(3) The gas inclusions are 80 to 2,800 years younger than the age of the ice in which they are entrapped. (See, for example, Reference 36.) This assumption is needed to accommodate the data from the shallow ice cores, which show that air entrapped in 19th century ice, or earlier, exhibits levels of CO_2 , CH_4 , and N_2O similar to present atmospheric concentrations.

It has been pointed out that these assumptions are incorrect, and thus that the conclusions on low pre-industrial levels of atmospheric greenhouse gases are wrong. (See, for example, References 12, 22, 24-28.) However, this criticism was largely ignored by greenhouse gases glaciologists, who offered no convincing arguments to refute this criticism in the one and only paper that it provoked.³⁷

In addition to this biased selection of experimental evidence, there are many technical aspects to the science of glacial ice analysis that are ignored by the global warming enthusiasts in their desire to bolster their arguments with glacial data. Presented here are some of the scientific points eliminated by the global warming advocates.

Chemical Fractionation

A striking feature of the ice core arguments that there is a recent man-made increase of atmospheric CO_2 , CH_4 , and N_2O , is that all the ice core data are from ice deposited not in the last few decades, but in the 19th century or earlier. No information is presented on the recent concentrations of greenhouse gases in firn and ice deposited in the 20th century. Instead, the concentrations of greenhouse gases found in the pre-industrial ice are compared with the concentration of these gases in the contemporary free atmosphere.¹²

To justify such comparisons, an assumption is required that the entrapment of air in ice does not involve any chemical fractionation of gases. However, there are more than 20 chemical and physical processes that change the original chemical and isotopic composition of ice and of gas inclusions recovered from the ice cores.¹² Even the composition of air from near-surface snow in Antarctica is different from that of the atmosphere; the surface snow air was found to be depleted in

“No study has yet demonstrated that the content of greenhouse trace gases in old ice, or even in the interstitial air from recent snow, represents the atmospheric composition.”

CO_2 by 20 to 50 percent. (See references in Reference 12.)

Chemical and isotopic fractionation of gases occurs at the occlusion of air in snowflakes, in interstitial air in near-surface snow (effects of insolation), deep in the firn and ice, and in the ice cores. In the upper snow and firn strata, fractionation occurs on a time scale of days and of a few years; but deep in the ice, it occurs on a scale of up to hundreds of thousands of years. Fractionation is caused by the differences in solubility in cold water of air components, chemical reactions, formation of gas clathrates and gravitational thermal effects.¹² (Clathrates are compounds formed by the inclusion of one type of molecule in the cavities of the crystal lattice of another.) In firn, fractionation is related to subsurface melting of ice crystals, evaporation of water, transport of vapor in firn pores along the thermal gradient, liquefaction of vapor, formation of ice layers and depth hoar (Figure 2).

Most of these processes are related to liquid water, which is present in the cold snow and ice down to the temperature of $-73^{\circ}C$,³⁸ to pressure and temperature changes, and to metamorphosis of snow crystals.¹² The fractionation of gases as a result of their various solubilities in water (CH_4 is 2.8 times more soluble than N_2 in water at $0^{\circ}C$; N_2O , 55 times; and CO_2 , 73 times), starts from the formation of snowflakes, which are covered with a film of supercooled liquid.²² Gases dissolved first in liquid water are then equilibrated with air trapped in the firn pores and in the air bubbles of the solid ice.

Carbonates and other impurities present in the ice sheet—such as the reactive species HNO_3 (nitric acid), HCl (hydrochloric acid), H_2O_2 (hydrogen peroxide), SO_2 (sulfur dioxide), and O_3 (ozone), as well as catalysts such as copper, iron, manganese, or particulate matter—are dissolved or suspended in the liquids present at the surface of snow and ice grains, and can react with themselves (for example, producing or consuming CO_2), or with the greenhouse gases. Oxidation or reduction processes occur not only in the upper firn part of the ice sheet, where solar radiation penetrates, but also in the deep, dark parts. This is indicated by sharp decreases in H_2O_2 concentration profiles observed deep in the ice sheet, and also by the systematic decrease of its concentration with depth (for references, see Reference 22).

Another important process is differential formation and dis-

sociation of pure and mixed clathrates (hydrates) of greenhouse gases and of major components of air. Dissociation pressures are much lower for greenhouse gases than for oxygen and nitrogen. At -20°C , these pressures are only 4, 5, and 13.5 bars, for N_2O , CO_2 , and CH_4 , respectively; but these pressures are 120 bars for N_2 , and 160 for O_2 . At -20°C in the ice sheet, CO_2 gas begins to change into the CO_2 clathrate (a white solid discovered in 1882 by Zygmunt F. Wróblewski, a physicist who first liquefied air,^{39,40}) and to disappear from the gas in the air bubbles, at a depth of about 70 m, where the load pressure increases to 5 bars.

On the other hand, O_2 and N_2 change into clathrate crystals at much greater depth of about 900 to 1,200 m, where all gases finally enter the clathrate form, or diffuse into liquids and ice crystals. Therefore, at this depth, all air bubbles disappear completely from the ice. Now, what happens when ice cores are decompressed and recovered at the surface of the ice sheet: In the bubble-free ice, new artificially created gas cavities are formed from the clathrate crystals dissociating at the lower pressure (Figure 2). This dramatic phenomenon is played down, (for example, see Reference 41), or ignored, in publications on greenhouse gases.

It was found experimentally that the partial pressure of the gas is not a determining factor for the dissociation pressure of clathrates, which become enriched in components that form clathrates readily. In contrast, the free-gas phase becomes enriched with components that do not easily form clathrates.⁴² The occurrence of clathrates causes depletion of greenhouse gases in two stages: (1) during clathrate formation in the ice sheet, when greenhouse gases enter the clathrate form and leave the air bubbles earlier than N_2 and O_2 ; and (2) in the ice cores after relaxation of the load pressure, when N_2 and O_2 clathrates dissociate long before the greenhouse gases, forming secondary gas cavities in the ice.

This latter phenomenon is associated with micro-explosive changes in the core structure⁴³ (Figure 2), and formation of micro- and macro-cracks, which, together with the stress fracturing of ice, leads to molecular and isotopic fractionation of gases.⁴⁴

As mentioned above, in some gas inclusions from pre-industrial ice, concentrations of greenhouse gases were found similar to, or much higher than, those of the present atmosphere. In some gas inclusions, changes in CO_2 concentrations of up to 50 ppmv have been measured over distances of only 2.5 cm in the cores.⁴⁵ Such inhomogeneous distribution of CO_2 concentrations obviously does not reflect the changes in the composition of the atmosphere, but is the result of the random character of fractionation processes.

However, as discussed in References 12 and 22, the prevalent effect of fractionation of gases in the ice sheets, and in the recovered ice cores, is the preferential depletion of greenhouse gases in the air bubbles, and in the secondary gas cavities. For this reason, most gas samples recovered from polar ice cores had concentrations of trace gases that were much lower than those of the present atmosphere, even in ice dating from periods when the global surface temperature was higher than the present by 0.5 to 1.3°C —for example, during the Eemian interglacial period, 125,000 to 130,000 years ago; in the mid-Holocene, 5,000 to 6,000 years ago; or during the Medieval warm period, 1,200 years ago.¹¹

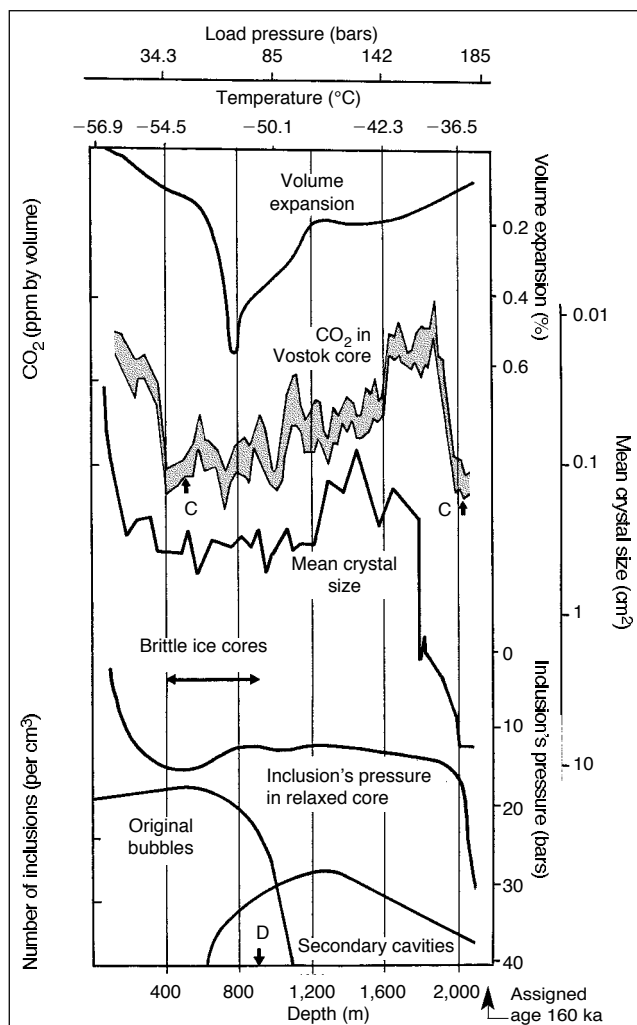

Figure 4
PROCESSES CAUSING CONTAMINATION OF ANTARCTIC ICE CORE SAMPLES

Shown here are the many processes that influence the chemical and isotopic composition of air inclusions in ice sheets and in the ice cores, based on the data from the Vostok and Byrd stations, Antarctica. The vertical arrow D (at bottom) indicates the total disappearance of air bubbles in the Vostok core. The vertical arrows C (at middle, left and right) indicate the sites of highest contamination of the inner parts of the Vostok core with lead, zinc, aluminum, and sodium from drilling fluid.

Source: Adapted from Jaworowski et al., 1992

The CO_2 concentrations in air bubbles in ice from the years 1000 to 1800, remained remarkable stable: 270 to 290 ppmv, even though during the Little Ice Age of the 16th to 19th century, the global temperature decreased about 1°C . Such a long-term drop in global temperature should be reflected as a decrease in the CO_2 content in the atmosphere, because of higher CO_2 solubility in the colder oceanic water, and reduced oxidation processes on land and sea (see discussion below).

The lack of this effect in the air bubbles in ice seemed "sur-

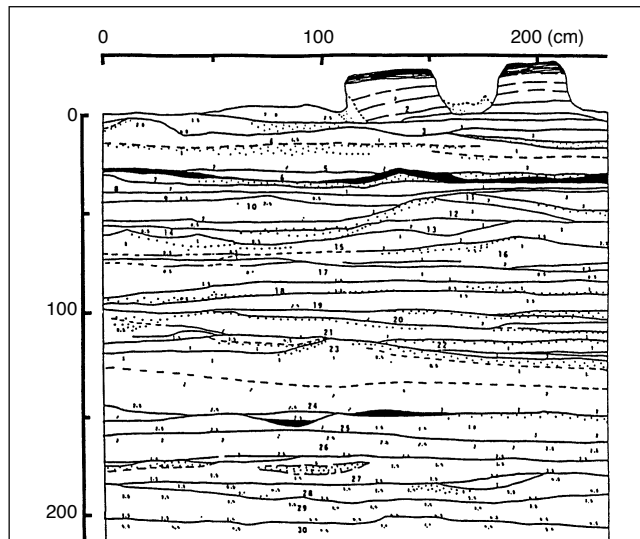

Figure 5
ICE SHEET STRUCTURE BARS
AIR PENETRATION INTO FIRN

The ice crust evidence indicates that high density ice strata form a multilayer structure that separates the firn into horizontal pockets, a structure that prevents air penetration into the firn. Thus assumptions that air and ice ages are different, used to bolster the global warming theory, are not correct. Shown here is firn stratigraphy in a pit at Mizuho Plateau (East Antarctica), where the mean annual temperature is -51°C . The solid lines indicate the ice crusts.

Source: Adapted from Watanabe 1977

prising” for the authors of the Intergovernmental Panel on Climate Change report in 1990, who deduced from it that the sensitivity of atmospheric CO_2 to such climatic fluctuations is small. However, the CO_2 atmospheric content is very sensitive even to short-term and much smaller changes of global temperature, as will be shown below. It is much more plausible that the long-term changes of concentration of greenhouse gases in the gas inclusions from ice sheets represent the cumulative effect of the interplay of many processes occurring in the ice sheet and in the ice cores, rather than composition of the ancient atmosphere (Figure 4).

The Age of Air in Bubbles

An ad hoc, speculative assumption that the air in bubbles in ice is 90 to 200 years younger than the ice in which the bubbles are entrapped, was posed at a time when the concentrations of greenhouse gases in air bubbles from ice deposited in the 18th and 19th century were found to be similar to those of the present atmosphere.^{46, 47}

No experimental evidence was offered in support of this assumption. Instead, Craig et al. offered the circular-logic argument that this speculation must be correct, because the ice core data for a greenhouse gas with the ages corrected in this way “lead rather precisely into the recent atmospheric measurements!”⁴⁷ Later, the assumption for the difference between the age of the air and the age of the ice was theoretically, but not experimentally, elaborated, with estimations of this difference for various polar sites ranging between 90 and 2,800 years.³⁶ These estimations were simply based on the age of the firn/ice transition. It was supposed that in the Greenland and Antarctic sites, where the mean annual temperature is -24°C or less, the whole column of firn was devoid of ice layers that were impermeable to atmospheric air. Further, it was believed

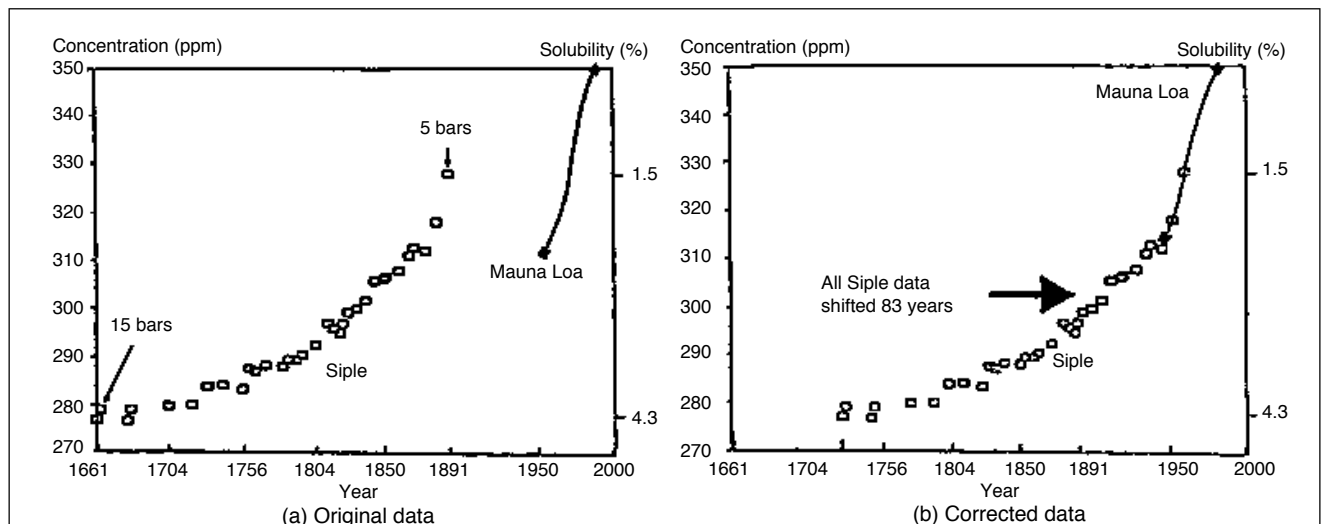

Figure 6

CORRECTING THE CO_2 ICE DATA TO FIT THE THEORY: AN EXAMPLE FROM SIPLE, ANTARCTICA

The figures here show measurements of CO_2 in pre-industrial ice (open squares) and CO_2 as measured in the atmosphere at Mauna Loa, Hawaii (solid line). The original data are shown in (a). The same data appear in (b) after an arbitrary “correction” of 83 years in the age of the air, to make the data accord with the global warming theory. Using the real age of the air, could indicate that the CO_2 concentrations in the latter 19th century were the same as those in the 1970s. The “corrected” data were published by Neftel et al. 1985; Friedli, et al. 1986; and IPCC, 1990.

that this air can freely penetrate into the ice sheet, down to the firn/ice transition at about 40 to 120 m depth, where final occlusion of the firn pores occurs.

However, as discussed in Reference 12, the formation of ice crusts has been recorded at many sites with mean annual surface air temperature reaching -57°C . Numerous Japanese, Russian, and Norwegian stratigraphic studies have demonstrated that such high density ice strata (layers) are ubiquitous in the Antarctic ice sheet, where they form a multilayer structure (1 to 15 strata per meter depth), separating firn into horizontal pockets (Figure 5). This structure acts as a barrier to the free penetration of air into firn. The chemical and stable isotope fractionation of CO_2 , CH_4 , N_2 , and O_2 occurring in the air trapped in the porous Greenland firn, indicates that this air in firn is isolated from the atmosphere.⁴⁷ On this basis, Craig et al. revoked their earlier estimate of a difference between age of air and ice.⁴⁸

Thirteen years after the age assumption was postulated, and it was accepted on this basis that the level of greenhouse gases was lower in the pre-industrial atmosphere than now, an attempt was made to prove its validity in an experiment carried out in a borehole at Summit, Greenland.²¹ At this site, the authors estimated the air/ice age difference as 210 years. As was indicated in Reference 22, the interpretation of the results in this experiment ignored Darcy's law on flow in porous media. CO_2 concentration measured in air from about 214-year-old firn ranged from 242.3 to 435.7 ppmv; and from 50-year-old firn, it ranged from 347 to 641.4 ppmv. Such concentrations do not represent the composition of atmospheric air, but rather the fractionation processes in the ice sheets, and experimental artifacts.

The consequence of the assumption that the air in bubbles is younger than the ice in which the bubbles are found, is evident in Figure 6(b), which is widely accepted as a "proof" that the level of CO_2 in the atmosphere has been increased by man's activities.¹¹ The same erroneous procedure was also used for other greenhouse gases. In the case of CO_2 , the data from the 19th century ice collected at Siple, Antarctica, were made to overlay exactly the present atmospheric CO_2 concentrations measured at an active and CO_2 -emitting volcano, Mauna Loa, Hawaii—by assuming, arbitrarily, that the occluded air is 83 years younger than the ice.

Without this "correction," and using the real age of ice, the Siple and Mauna Loa curves do *not* correspond, and could indicate that CO_2 atmospheric concentration was the same in the latter part of the 19th century as in the 1970s. One can also note that the CO_2 concentration in the air bubbles decreases with the depth of the ice for the entire period between the years 1891 and 1661, not because of any changes in the atmosphere, but along the increasing pressure gradient, which is probably the result of clathrate formation, and the fact that the solubility of CO_2 increases with depth.¹²

Cracked and Contaminated Ice Cores

Another area ignored by the global warming advocates concerns the condition of the ice core samples, as a result of the sampling procedure. Drilling the ice cores is a brutal procedure, subjecting the ice to mechanical and thermal stress, drastic decompression, and pollution. These factors cause micro- and macro-cracking of the ice, opening the original air

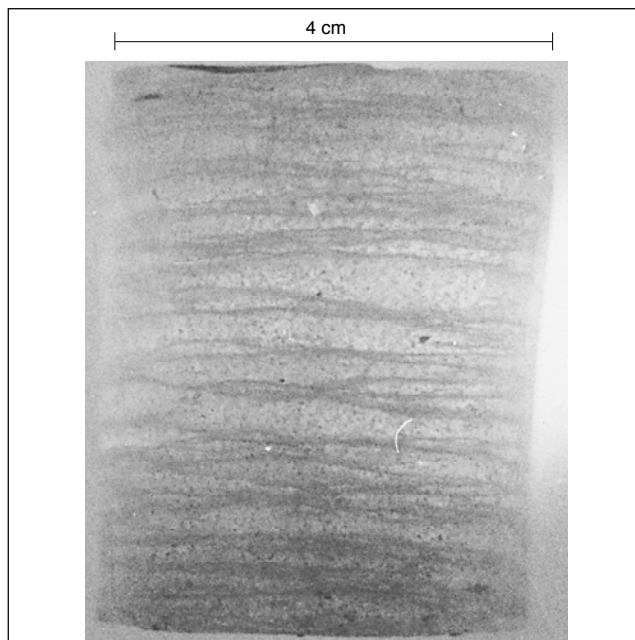

Figure 7

CRACKING IN ICE CORE SAMPLES AS A RESULT OF DRILLING AND TRANSPORTATION UPWARDS

A photograph in transmitted light of the inner part of an ice core from the Mizuho Plateau (East Antarctica), at a depth of 356 m. Note a dense structure of "healed" macro-cracks, which do not disturb the mechanical integrity of the core. Before "healing," the cracks were open to migration of gases and pollutants, which affect the measurements of greenhouse gases.

bubbles and forming artificially created secondary air cavities in the bubble-free, deep ice, and causing internal contamination of cores.

A dense network of horizontal fractures is created in the ice cores by a sheeting phenomenon that occurs as the result of elastic relaxation of load pressure of more than about 8 bars; that is, in cores at a depth below 110 meters. The cracking occurs during the drilling and upward transportation of the core in the borehole, which is filled with a wall-retaining drilling fluid. The small cracks are soon healed by regelation, and their remnants are visible as horizontal stratification of the cores. The effects of this sheeting phenomenon, well known to geologists and glaciologists, are demonstrated in Figure 7. The same horizontal cracking is visible in a similar photograph of Vostok core.⁴⁹

Drilling fluid (diesel oil, jet fuel, and so on, with aggressive organic substances added for density regulation and antifreeze purposes) enters the cracks and penetrates into the central parts of the cores, and into the air bubbles and secondary gas cavities formed by dissociating clathrates. In the classic papers on greenhouse gases in polar ice, the reader is not informed about the method of drilling, or about the use of a drilling fluid (for example, see Reference 50). The gases released by decomposition of clathrates can escape into the drilling fluid before the cracks are healed at the surface of the ice sheet. As suggested by Craig et al., the molecular and isotopic fractionation

of gases may occur during this process.⁴⁸

Numerous studies on radial distribution of metals in the cores (for example, Reference 51) reveal an excessive contamination of their internal parts by the metals present in the drilling fluid. In these parts of cores from the deep Antarctic, ice concentrations of zinc and lead were higher by a factor of tens or hundreds of thousands, than in the contemporary snow at the surface of the ice sheet (Figure 8). This demonstrates that the ice cores are not a closed system; the heavy metals from the drilling fluid penetrate into the cores via micro- and macro-cracks during the drilling and the transportation of the cores to the surface.

During this drilling process, the ice cores become porous and open to both inflow and outflow of gases and liquids. The sheeting phenomenon, and about 20 physical and chemical processes that occur in the ice sheets and in the ice cores, make the ice and its gas inclusions an improper material for reconstruction of the levels of greenhouse gases in the ancient atmosphere.¹²

It is astonishing how credulously the scientific community and the public have accepted the clearly flawed interpretations of glacier studies as evidence of anthropogenic increase of greenhouse gases in the atmosphere. Future historians can use this case as a warning about how politics can negatively influence science.

Using Carbon Isotope Evidence for CO₂

Analysis of glacier ice is not the only way to estimate the anthropogenic contribution to the current CO₂ content in the atmosphere. Carbon present in CO₂ is composed of two stable isotopes, carbon-12 and carbon-13. Their ratio is commonly expressed as the δ¹³C (delta carbon-13) value. This value differs in various components of the environment. For average crustal carbon, it is -7 per mill;⁵² for atmospheric CO₂ in isotopic equilibrium with marine HCO₃⁻ and CaCO₃ (calcium carbonate), it has been estimated to be about -7 per mill;⁵³ measured in atmospheric CO₂ in 1956, it was -7.00 per mill;⁵⁴ and in 1988, -7.807 per mill;⁵⁵ and for fossil fuel and biogenic carbon it is -26 per mill.⁵⁶ Such great differences in the isotopic signature of fossil fuel and biogenic carbon make possible the estimation of the current and past contributions from this source to the atmosphere, because mixing even relatively small amounts of CO₂ with so low a δ¹³C value should change the average natural δ¹³C of atmospheric CO₂.

This estimation can be made by carbon isotope mass balance calculations. For example, between 1956 and 1988, the CO₂ concentration in the atmosphere changed from 315.6 ppmv to 351.2 ppmv;⁷ that is, by 10.14 percent. If this change were caused solely by anthropogenic emissions of CO₂ with δ¹³C of -26 per mill, then in 1988, the average atmospheric δ¹³C should be

$$(-7 \text{ per mill} \cdot 0.8989) + (-26 \text{ per mill} \cdot 0.1014) = -8.927 \text{ per mill}$$

and not -7.807 per mill, as measured by Keeling et al. at Mauna Loa, Hawaii.⁵⁵ With a 21 percent increase in atmospheric CO₂ caused by human activities, as claimed by the IPCC on the basis of glacier studies,¹¹ and with a preindustrial δ¹³C value of -7 per mill, the current δ¹³C of airborne

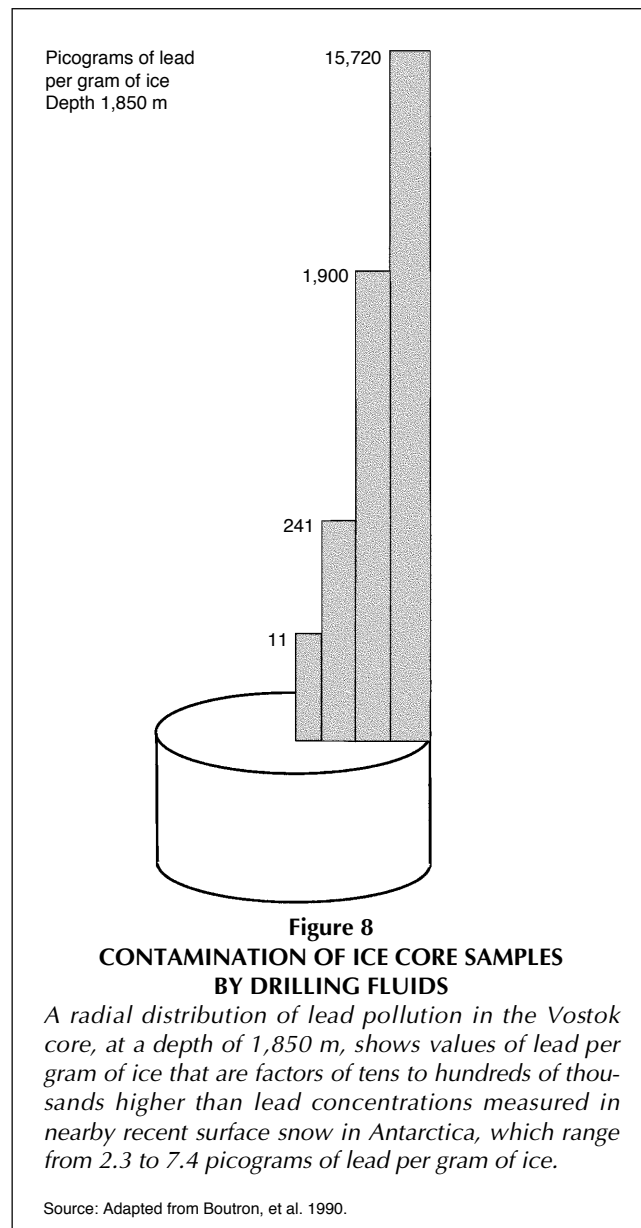

CO₂ should decrease to about -11 per mill. Such a low value was never determined

Such data conflict with the whole structure of the greenhouse warming hypothesis and, in particular, these data conflict with the unrealistically long atmospheric lifetime of CO₂ of up to 200 years assumed by the IPCC.¹¹ This assumption allows the accumulation of a rather small annual fossil-fuel and land-use increment of about 6 gigatons of carbon (GtC) per year, to about the 150 GtC assumed atmospheric increase between 1869 and 1990. The δ¹³C value measured in 1988, which is much higher than the result of isotopic mass balance calculation, suggests that in 1988, anthropogenic sources contributed only a small fraction to the total of atmospheric CO₂. This fraction can be quantified in the following way:⁵⁷

In 1991, the author, together with Tom V. Segalstad from Oslo University, calculated the isotopic composition of the December 1988 atmospheric total CO₂ pool of 748 GtC reported

by the IPCC in 1990, in which Keeling et al. (1989) measured a $\delta^{13}\text{C}$ of -7.807 per mill. We made these calculations for three components of the CO_2 pool: (1) the fraction of natural CO_2 with $\delta^{13}\text{C}$ of -7 per mill remaining from the pre-industrial atmosphere (pre-1750); (2) the fraction of natural CO_2 with $\delta^{13}\text{C}$ of -7 per mill remaining from the period 1750-1988; and (3) the cumulative CO_2 fraction remaining from each annual emission of fossil-fuel CO_2 from 1860 to 1988, with a $\delta^{13}\text{C}$ of -26 per mill.

For various atmospheric lifetimes of CO_2 , we calculated the mass N of each component remaining in 1988 from particular years, using the equation

$$N = N_0 e^{-\lambda t}$$

where N_0 is the annual injection of CO_2 (in GtC) at a time t (in years) before the end of December 1988 from natural sources or fossil fuel burning, and λ is the removal constant (reciprocal lifetime) for various atmospheric CO_2 lifetimes between 2 and 200 years. The isotopic mass balance calculations demonstrated that the lifetime fitting the 1988 criteria of $\delta^{13}\text{C}$ of -7.807 per mill, and of the mass of atmospheric CO_2 of 748 GtC, is only 5 years. Neither longer nor shorter lifetimes give realistic isotopic mass balance results.

The atmospheric CO_2 lifetime of about 5 years agrees with numerous estimates based on measurements of atmospheric carbon-14 from natural sources and nuclear tests.^{58,59} Significant amounts of carbon-14 from nuclear tests penetrated deep into the ocean, in a relatively short time; 10 years after the most intensive test in 1962, carbon-14 was found at a depth of 5,000 m in the North Atlantic.⁶⁰ A similar CO_2 atmospheric lifetime was also estimated by Starr from the seasonal atmospheric CO_2 variations.⁶¹ The implication of the 5-year lifetime, is that about 18 percent—that is, 135 GtC, of the atmospheric CO_2 pool—is exchanged each year. An anthropogenic contribution of about 6 GtC per year pales in comparison with this vast natural flux.

The results of our calculations also indicate that the mass of CO_2 from all past fossil-fuel emissions remaining in the December 1988 atmosphere was about 30 GtC—that is, about 4 percent (and not 21 percent) of the 1988 atmospheric CO_2 pool, corresponding to an atmospheric CO_2 concentration of about 14 ppmv. The content of non-fossil-fuel and non-biogenic CO_2 with $\delta^{13}\text{C}$ of -7 per mill in the December 1988 atmosphere was about 718 GtC. This corresponds to a pre-industrial atmospheric CO_2 concentration of about 339 ppmv. The fossil-fuel component would be less if emissions from terrestrial biota (with similar $\delta^{13}\text{C}$ to that of fossil fuel) were included in the calculation. The estimate by Guthrie and Smith⁶² of 35 GtC remaining from 1860 to 1990 in fossil-fuel CO_2 emissions, based on (non-isotope) mass balance calculations and a 5.1 year atmospheric lifetime of CO_2 , is close to our result.

The current atmospheric CO_2 pool is dominated by the natural CO_2 with $\delta^{13}\text{C}$ of -7 per mill degassed from the ocean. The 4 percent anthropogenic contribution to this pool is prob-

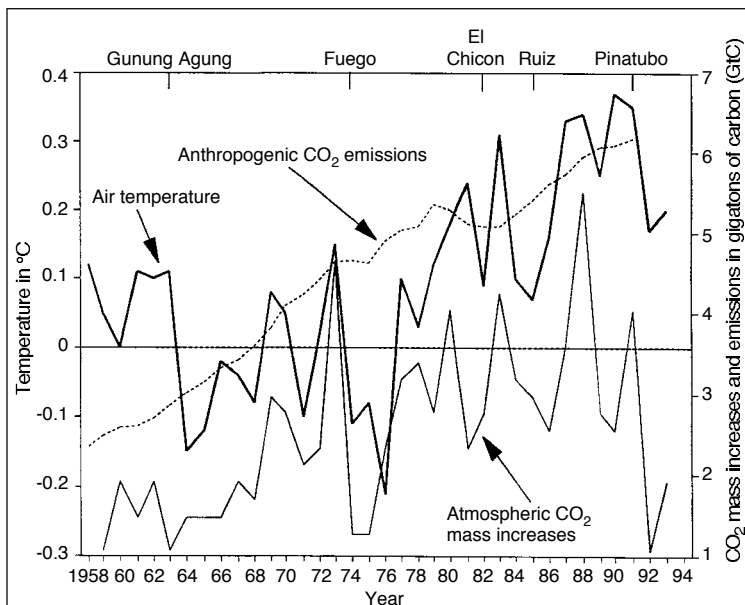

Figure 9
ANNUAL CHANGES IN ATMOSPHERIC CO_2 FOLLOW TEMPERATURE CHANGES, NOT MAN-MADE EMISSIONS

The increases in man-made emissions of CO_2 (dotted line) are not coupled to the fluctuations in the atmospheric CO_2 (thin solid line). Instead, zig-zags of changes in atmospheric CO_2 , seem to closely follow changes in temperature (heavy solid line). The largest decreases in CO_2 occur after volcanic eruptions reach the stratosphere. Volcanic eruptions are noted at top.

The source of temporal trends in anthropogenic CO_2 emissions from fossil fuel burning and cement production is taken from Boden, et al., 1990; Andres, et al., 1993. The data for atmospheric CO_2 mass increases are calculated from CO_2 air concentrations measured at Mauna Loa, Hawaii, and are taken from Boden, et al., 1990; Keeling, et al., 1995. The global surface air temperature is taken from Boden, et al., 1990; Keeling, et al., 1995.

ably smaller than the variations of CO_2 flux from natural sources caused by climatic instabilities.

CO_2 Increases Not the Result of Human Activity

Atmospheric CO_2 concentration increased from 315.6 ppmv in 1958, to 359 ppmv in 1994.^{7,63} As these concentrations correspond to an atmospheric CO_2 mass of 669 GtC and 761 GtC, respectively, the cumulative increase during 37 years was 92 GtC; that is, about 14 percent of the 1958 atmospheric mass of CO_2 . The average annual increase in this period was then about 2.5 GtC.

Each year about 12 percent (that is, 92 GtC) of the total atmospheric mass of CO_2 exchanges with the ocean, and about 13 percent (102 GtC) with the land biota (IPCC 1990). It is possible that the observed CO_2 increase is the result of a small change in this annual natural CO_2 flux, caused by increased degassing from the warmer ocean, and increased oxidation processes at land and sea, resulting from natural climatic fluctuation. This possibility was not discussed in the IPCC's 1990 document.

The IPCC estimated that the temperature of the surface wa-

ters increased between 1910 and 1988 by about 0.6°C. A similar increase was observed in the surface air temperature in this period. Increasing the average temperature of the surface of the oceanic waters (15°C) by 0.6°C, would decrease the solubility of CO₂ in these waters (0.1970 g CO₂ per 100 g) by about 2 percent. The CO₂ flux from the ocean to the atmosphere should be increased by the same factor; that is, by about 1.9 GtC/year. This is similar to the observed average increase of atmospheric CO₂ in the years 1958 to 1968, of 0.73 ppmv/year,⁷ which corresponds to 1.6 GtC/year. The measured annual atmospheric CO₂ increases were higher in the next two decades (2.5 GtC/year and 3.4 GtC/year),⁷ which indicates that changes in CO₂ solubility in oceanic water were responsible only for a part of observed CO₂ increases. Inorganic processes on land and changes in marine and terrestrial biota could also contribute to these increases.

The atmospheric air and sea surface temperatures did not increase smoothly during this period, but were rather irregular, zig-zagging from year to year (Figure 9). The annual changes in atmospheric CO₂ mass closely followed the temperature changes. This was probably the result of rapid equilibration between CO₂ concentration in the atmosphere, and the dissolved inorganic carbon in the sea in about three quarters of a year.⁶⁴

The greatest cooling and largest decreases in the rate of atmospheric CO₂ increase occurred after volcanic eruptions which reached the stratosphere, characterized by high dust veil index: Gunung Agung in 1963, Fuego in 1974, El Chichon in 1982, Nevado del Ruiz in 1985, and Pinatubo in 1991.

On the other hand, the smoothly and steadily growing annual increases in anthropogenic emissions of CO₂ from fossil fuel burning and cement production, do not match the atmospheric CO₂ fluctuations. Since 1988, these sharply growing anthropogenic emissions have not been associated with decreasing values of δ¹³C of atmospheric CO₂,⁶³ for 7 years between 1988 and 1994, this latter value remained remarkably stable. If the observed changes in CO₂ concentration were man-made, a decrease in δ¹³C should be observed.

During the famous "energy crisis" in 1974-1975, there was practically no decrease in anthropogenic CO₂ emissions, but there was a dramatic drop in annual mass increase of atmospheric CO₂ associated with atmospheric cooling; in 1983, the decreasing anthropogenic CO₂ emission rate was associated with a peak in the rate of atmospheric CO₂ mass increase, preceded by a cooler air temperature in 1982; in 1992, the highest rate of anthropogenic CO₂ emission was associated with one of the deepest drops in atmospheric CO₂ mass increase, and air cooling.

The data in Figure 9 suggest that CO₂ atmospheric mass increases were *not* related to man-made emissions of this gas, but rather that these increases depended on volcanic eruptions and other causes of natural climatic fluctuations.

Notes

1. I. Langmuir, 1989. *Phys. Today*, October, p. 36.
2. S. Arrhenius, 1896. *Philos. Mag. J. Sci.*, Ser. 5, Vol. 41, p. 237.
3. G.S. Callendar, 1938. *Q.J.R. Meteorol. Soc.*, Vol. 64, p. 223.
4. ———, 1940. *Q.J.R. Meteorol. Soc.*, Vol. 66, p. 395.
5. ———, 1958. *Tellus*, Vol. 10, p. 243.
6. G. Slocum, 1955. *Mon. Weather Rev.*, (October), p. 225.
7. T.A. Boden, et al., 1990. *Trends '90*, Report ORNL/CDIAC-36, p. 257.
8. Z. Jaworowski, et al., 1992. "Atmospheric CO₂ and Global Warming: A

- Critical Review, Norwegian Polar Institute, Oslo, *Meddelelser*, Vol. 19, No. 1, p. 76.
9. J. Emsley, ed., 1996. *The Global Warming Debate* (London: European Science and Environment Forum), p. 288.
10. "International Commission Report of the Workshop on Snow and Ice," held March 6-7, 1992, at the University of New Hampshire, p. 17.
11. Intergovernmental Panel on Climate Change, 1990. "Climate Change: The Intergovernmental Panel on Climate Change Scientific Assessment," p. 365
12. Z. Jaworowski, et al., 1992. *The Sci. Tot. Environ.*, Vol. 114, p. 227.
13. H. Oeschger, et al., 1988. *Ann. Glaciol.*, Vol. 10, p. 215.
14. I.G. Enting, 1992. *Tellus*, Vol. 44B, p. 23.
15. I.G. Enting, et al., 1987. *Tellus*, Vol. 39B, p. 318.
16. G. Landmann, et al., 1996. *Palaeogeogr. Palaeoclimat. Palaeoecol.*, Vol. 122, p. 107.
17. W. Dansgaard, 1954. *Geochim. Cosmochim. Acta*, Vol. 6, p. 436.
18. ———, 1977. IAHS Publication No. 118, p. 401.
19. K. Satow, et al., 1985. *Ann. Glaciol.*, Vol. 6, p. 256.
20. G. Heinsohn, 1994. *Vorzeit-Frühzeit-Gegenwart*, Vol. 4, p. 76.
21. J. Schwander, et al., 1993. *J. Geophys. Res.*, Vol. 98, p. 2831.
22. Z. Jaworowski, 1994. *Environ. Sci. & Pollut. Res.*, Vol. 1, p. 162.
23. A. Nefftel, et al., 1982. *Nature*, Vol. 295, p. 220.
24. H.-E. Heyke, 1992. *Erdöl und Kohle-Erdgas-Petrochemie*, Vol. 45, p. 360.
25. H.-E. Heyke, 1992. *Fusion*, No. L3, p. 32.
26. Z. Jaworowski, 1996. "Reliability of Ice Core Records for Climatic Projections," in *The Global Warming Debate* (London: European Science and Environment Forum), p. 95.
27. Z. Jaworowski, et al., 1991. *Atmospheric CO₂ and Global Warming: A Critical Review* (Oslo: Norsk Polarinstittutt, Rapportserie No. 59), pp. 1-75.
28. Z. Jaworowski, et al., 1992. *Atmospheric CO₂ and Global Warming: A Critical Review* (Oslo: Norsk Polarinstittutt, second revised edition), *Meddelelser*, No. 119, pp. 1-76
29. A. Nefftel, et al., 1988. *Nature*, Vol. 331, p. 609.
30. G.I. Pearman, et al., 1986. *Nature*, Vol. 320, p. 248.
31. M. Leuenberger, et al., 1992. *Nature*, Vol. 360, p. 449.
32. D.M. Etheridge, et al., 1988. *Ann. Glaciol.*, Vol. 10, p. 1.
33. D. Zardini, et al., 1989. *J. Atmos. Chem.*, Vol. 8, p. 189.
34. H. Oeschger, et al., 1985. *Geophysical Monographs*, Vol. 32, p. 132.
35. D. Raynaud, et al., 1985. *Nature*, Vol. 315, p. 309.
36. J. Schwander, et al., 1984. *Nature*, Vol. 311, p. 45.
37. D. Raynaud, et al., 1993. *Science*, Vol. 259, p. 926.
38. R. Mulvaney, et al., 1988. *Nature*, Vol. 331, p. 247.
39. S. Wróblewski, 1882. *Compt. Rend.* Vol. 24, p. 212.
40. ———, 1882. *Compt. Rend.* Vol. 24, p. 954.
41. A. Nefftel, et al., 1983. *J. Phys. Chem.*, Vol. 87, No. 41, p. 16.
42. Y.F. Makagon, 1974. *Gidraty Prirodnikh Gazov* (Moscow), p. 208.
43. H. Shoji, et al., 1982. *Nature*, Vol. 298, p. 548.
44. H. Craig, et al., 1988. *Science*, Vol. 242, p. 1535.
45. A. Nefftel, 1991. *Seasonal Snowpacks* (Berlin), p. 386.
46. W. Berner, et al., 1980. *Radiocarbon*, Vol. 22, p. 227.
47. H. Craig, et al., 1982. *Geophys. Res. Lett.*, Vol. 2, p. 1221.
48. H. Craig, et al., 1988. *Science*, Vol. 242, p. 1535.
49. S. H. Schneider, 1989. *Sci. Am.*, Vol. 261, p. 38.
50. J.M. Barnola, et al., 1987. *Nature*, Vol. 329, p. 408.
51. C.F. Boutron, et al., 1990. *Earth Planet. Sci. Lett.*, Vol. 101, p. 248.
52. A.N. Fuex and D.R. Baker, 1973. *Geochim. Cosmochim. Acta*, Vol. 37, pp. 2509-2521.
53. H. Ohmoto, 1986. *MSA Rev. Mineral.*, Vol. 16, pp. 491-559.
54. C.D. Keeling, W.G. Mook, and P.P. Tans, 1979. *Nature*, Vol. 277, pp. 121-123.
55. C.D. Keeling, R.B. Bacastow, A.F. Carter, S.C. Piper, T.P. Whorf, M. Heimann, W.G. Mook, and H. Roeloffzen, 1989. *Geophys. Mono.*, Vol. 55, pp. 165-236.
56. P. Tans, 1981. "Carbon Cycle Modelling, SCOPE 16" (Chichester: John Wiley & Sons), pp. 127-129.
57. T.V. Segalstad and Z. Jaworowski, 1991. "Carbon Isotope Mass Balance of Atmospheric CO₂," University of Oslo, unpublished.
58. UNSCEAR, 1977. "Sources and Effects of Ionizing Radiation," United Nations Scientific Committee on the Effects of Atomic Radiation, report to the General Assembly (New York: United Nations), p.725.
59. E.T. Sundquist, 1985. "Geological Perspectives on Carbon Dioxide and the Carbon Cycle," in E.T. Sunquist and W.S. Broecker (eds.), *The Carbon Cycle and Atmospheric CO₂: Natural Variations Archaean to Present*, AGU Geophysical Monograph, Vol. 32, pp. 5-60.
60. B. Bolin, 1989. "How Much CO₂ Will Remain in the Atmosphere?" *SCOPE 29* (Chichester: John Wiley & Sons), pp. 93-155.
61. C. Starr, 1993. *Energy*, Vol. 18, pp. 1297-1310.
62. M.B. Guthrie and S.P. Smith, 1993. Appendix in Starr (see Reference 61).
63. C.D. Keeling, T.P. Whorf, M. Wahlen and J. vander Plicht, 1995. *Nature*, Vol. 375, pp. 666-670.
64. B. Bolin, 1982. "Changing Global Biogeochemistry." In P.G. Brewer (ed.)