

21st CENTURY SCIENCE & TECHNOLOGY

SPRING 2003

www.21stcenturysciencetech.com

\$3.50/IN CANADA \$4.50

KRAFFT EHRICKE'S
EXPEDITION ARES

Music and the Unsolved Paradox of Pythagoras

- LaRouche
On the
Shuttle
Disaster
- The 'Solar Jerk'
and the
Earth's
Climate



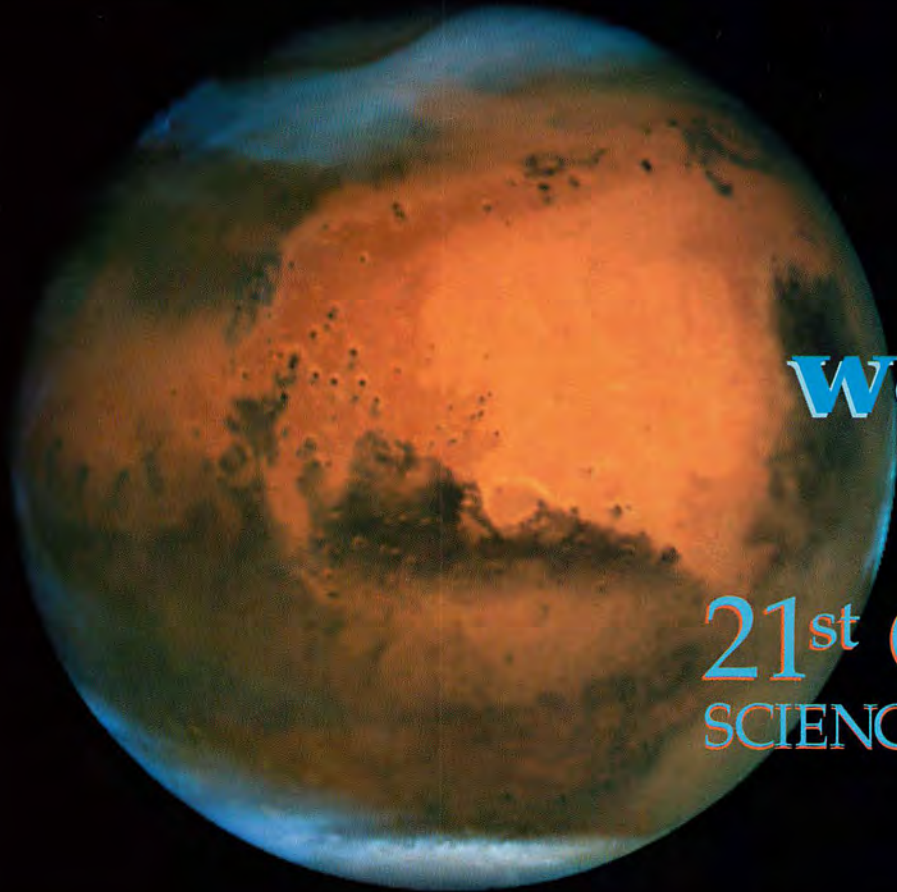

Expand your world view with

21st CENTURY SCIENCE & TECHNOLOGY

NASA and the Hubble Heritage Team

Mars, as captured by the Hubble Telescope, showing frosty white water ice clouds at the poles and swirling orange dust storms above a vivid rusty landscape.

Subscriptions

U.S.—6 issues for \$25

Foreign—6 issues for \$50

Books

The Holes in the Ozone Scare:

The Scientific Evidence

That the Sky Isn't Falling

by Rogelio A. Maduro and

Ralf Schauerhammer

\$15 each, plus \$3 shipping

OR \$10 postpaid with a subscription

How We Got to the Moon:

The Story of the German Space

Pioneers

by Marsha Freeman

\$15 each, plus \$3 shipping

OR \$10 postpaid with a subscription

Global Warming:

The Rest of the Story

by Dr. Gerd Weber

\$11 each, postpaid

OR \$8 postpaid with a subscription

Hermann Oberth:

The Father of Space Flight

by Boris V. Rauschenbach

\$15 each, plus \$3 shipping

OR \$12 postpaid with a subscription

Give 21st Century subscriptions and gifts

ORDER FORM

Enclosed is \$_____ for:

___ 6 issues/ U.S.— \$25

___ 6 issues/ foreign airmail—\$50

___ 12 issues/ U.S.—\$48

___ 12 issues/ foreign—\$98

___ \$10 for *The Holes in the Ozone Scare* with a subscription

___ \$18 postpaid for *The Holes in the Ozone Scare*

___ \$10 for *How We Got to the Moon* with a subscription

___ \$18 postpaid for *How We Got to the Moon*

___ \$8 for *Global Warming* with a subscription

___ \$11 postpaid for *Global Warming*

___ \$12 for *Hermann Oberth* with a subscription

___ \$18 postpaid for *Hermann Oberth*

Please print or type name and address of gift recipients on a separate paper. Gift cards are available.

Note: Back issues are available at \$5 each (\$8 foreign)

Name _____

Address _____

City _____ State _____ Zip _____

Daytime telephone (_____) _____ e-mail _____

Send check or money order (U.S. currency only) to:

21st Century, P.O. Box 16285, Washington, D.C. 20041.

www.21stcenturysciencetech.com

21st CENTURY SCIENCE & TECHNOLOGY

Vol. 16, No. 1

Spring 2003

Features

- 10 **MUSIC AND THE UNSOLVED PARADOX OF PYTHAGORAS**
Violin Building and the World of Harmonic Sound
Caroline Hartmann
Intervals in classical musical performance cannot be expressed by a predetermined mathematical ratio, nor can the building of great musical instruments be reduced to a formula.
- Appendix 1
18 **'A Completely Pure Music Is Absolutely Impossible'**
- Appendix 2
19 **The Construction of the Violin's Vaulting Curves**
- CLIMATE AND KEPLERIAN PLANETARY DYNAMICS
23 **The 'Solar Jerk,' the King-Hele Cycle, And the Challenge to Climate Science**
Rhodes W. Fairbridge
A senior Earth scientist divulges some little-known discoveries in planetary dynamics, and how they may affect Earth's climate.
- EXPEDITION ARES
29 **Introduction: Krafft Ehricke's Manned Mission to Mars**
Marsha Freeman
- 31 **A Saga from the Dawn of Interplanetary Travel**
Krafft A. Ehricke
An imaginary account of space travel in the year 2050, written in 1948 by preeminent space visionary Krafft Ehricke (1917-1984). These are excerpts from his unpublished manuscript.

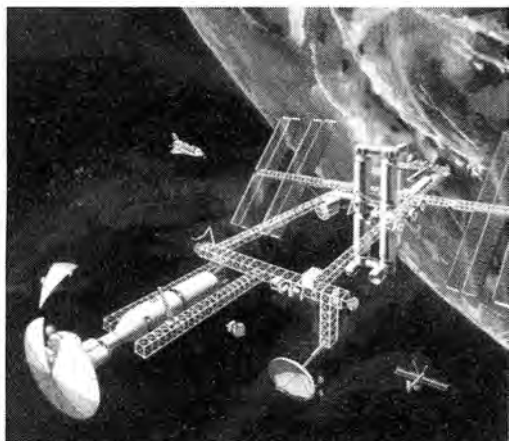

Marshall Space Flight Center

In the early days of the space program, it was assumed that man would travel to Mars and beyond. Here, an artist's illustration of the assembly of a manned Mars space vehicle in space. As in Krafft Ehricke's Expedition Ares, a space station would be used for assembling and checking out Mars vehicles.

News

SPACE
45 **Shuttle 'Fix' Means a Change In Economic Policy Axioms**
Marsha Freeman

INDEX
52 **2002 Author and Subject Index**

Departments

EDITORIAL
2 **On the Latest Shuttle Failure: Blame the Bookkeeper Mentality**
Lyndon H. LaRouche, Jr.

4 LETTERS

RESEARCH COMMUNICATION

5 **A Puzzling Current Loop**
Victor Morin

6 **Was the *Antikythera* an Ancient Instrument for Longitude Determination?**
Richard Sanders

8 NEWS BRIEFS

50 BOOKS RECEIVED

BOOKS

55 **Astronomy Encyclopedia: An A-Z Guide to the Universe**
Sir Patrick Moore, General Editor
Reviewed by David Cherry

56 **Touch the Universe: A NASA Braille Book of Astronomy**
by Noreen Grice
Reviewed by John Covici

On the cover: Photograph of violin in construction, courtesy of *Fusion* magazine; cover design by Alan Yue.

On the Latest Shuttle Failure: Blame the Bookkeeper Mentality

by Lyndon H. LaRouche, Jr.

EDITORIAL STAFF

Editor-in-Chief

Laurence Hecht

Managing Editor

Marjorie Mazel Hecht

Associate Editors

Elijah C. Boyd

David Cherry

Marsha Freeman

Colin M. Lowry

Gregory B. Murphy

Elisabeth Pascal

Richard Sanders

Charles B. Stevens

Books

David Cherry

Art Director

Alan Yue

Advertising Manager

Marsha Freeman

SCIENTIFIC ADVISORY BOARD

Francesco Celani, Ph.D.

Hugh W. Ellsaesser, Ph.D.

Bertha Farfán, M.D.

James Frazer, Ph.D.

John Grauerholz, M.D.

Emmanuel Grenier

Lyndon H. LaRouche, Jr.

Wolfgang Lillge, M.D.

Ramtanu Maitra

Thomas E. Phipps, Jr., Ph.D.

B.A. Soldano, Ph.D.

Jonathan Tennenbaum, Ph.D.

21st Century Science & Technology (ISSN 0895-6820) is published 4 times a year in 2000, every third month, by 21st Century Science Associates, 60 Sycolin Road, Suite 203, Leesburg, Va. 20175. Tel. (703) 777-7473.

Address all correspondence to **21st Century**, P.O. Box 16285, Washington, D.C. 20041.

Second-class postage is paid at Leesburg, Va. and additional mailing offices.

21st Century is dedicated to the promotion of unending scientific progress, all directed to serve the proper common aims of mankind.

Opinions expressed in articles are not necessarily those of 21st Century Science Associates or the scientific advisory board.

We are not responsible for unsolicited manuscripts.

Subscriptions by mail are \$25 for 6 issues or \$48 for 12 issues in the USA and Canada. Airmail subscriptions to other countries are \$50 for 6 issues. Back issues are \$5 each (\$6 foreign). Payments must be in U.S. currency.

POSTMASTER: Send address changes to 21st Century, P.O. Box 16285, Washington, D.C. 20041-0285.

Copyright © 2003

21st Century Science Associates

Printed in the USA ISSN 0895-682

www.21stcenturysciencetech.com

This statement was written Feb. 2, 2003. A physical economist, Lyndon H. LaRouche Jr. is a member of the Scientific Advisory Board of 21st Century, and is a candidate for the Democratic Party 2004 Presidential nomination.

Readers may also wish to see our coverage in the Space section (p. 45) and the featured item, a short story by space scientist Kraft Ehrlicke, (p. 29).

* * *

No one should draw a premature conclusion respecting the immediate causes for Saturday's awful news of the breakup of the *Columbia*. Nevertheless, we can be, and must be aware of a certain degree of preventable risk under which the NASA program has been compelled to operate, since radical changes in accountants-dictated policy which have continued to prevail, since the reckless arrangements installed during the period preceding the fatal, Jan. 28, 1986, launch of the *Challenger*.

Back in 1986, I was engaged in cooperation with a leading specialist in design of ballistic missile systems and countermeasures against ballistic missile attacks. During this period, he reported his anger at foolish changes in NASA policy, including the reckless way in which the environmentalist-lobby-demanded O-ring replacement was being rushed through, for the anticipated *Challenger* launch. The fatal blunder in that specific "budgetary" change imposed upon NASA policy, was of the same nature as the foolish change later adopted by Daimler-Benz in the original launching of the A-Klasse. The crime of negligence in those and kindred cases, is the increasing substitution of the mathematical methods of "ivory tower" systems analysis, and kindred recklessness, in letting today's "austerity-minded" financial accountants run firms, as a substitute for competent, traditional forms of actual

science and engineering practice.

Had advice such as his been heeded, the horror of the *Challenger* case would have been avoided. A kindred situation surrounds the policy-making blunders during the period preceding Saturday's developments. Experts who warned against risky "economy measures," were overruled, and dismissed, repeatedly, over the period preceding the *Columbia* disaster, in response to their policy reviews made during most recent years.

We can not undo now what happened on Saturday, but we must be rid of ill-conceived economy measures which doom essential programs, with what proven advice and experience have shown us to be a headlong rush into unnecessary risk.

Science and Safety

In the modern age of a slide, since the mid-1960s "sex change" from an earlier "producer society," into the decadent depths of a bankrupted "consumer society" culture, fascination with computer-generated numbers has become pathological in its growing disregard for experimental physical science. In earlier times, the scientist, engineer, and production manager waged a rear-guard defense of economic competence, against the "Gestapo gang" of Wall Street financial accountants, squatting like an occupying alien power in the corporate Treasury and Accounting departments. The cultural and economic down-shift of U.S. education, agriculture, and industry, took control of the U.S. economy during the ruinous cultural-paradigm shifts in economic policy of the 1971-1981 interval, during which the Federal government was under the dictatorship of the Nashville Agrarian clones Henry A. Kissinger and that loony "war-hawk" Zbigniew Brzezinski. Under the occupying powers represented by the Federal Reserve Chairmen Paul Volcker and Alan Greenspan, science and sanity have been driven from policy and from the minds of more and more of our uni-



NASA

"We must overcome a childish fear of the imagined 'bogyman,' and go out into the night to discover what is actually there. If we did not do that, we would be less than human." Here, the Jan. 16 launch of the orbiter Columbia on the 107th flight of a Space Shuttle.

versity-educated professionals. The loan-sharks and their predator bookkeepers have taken charge. These days, one rarely finds competence comparable to that formerly standard in the top ranks of corporate management.

These escalating changes in cultural paradigms, launched on a mass scale during the 1964-1981 interval, are the crucial changes to consider in the frequent recklessness of our government's direction of our space policy.

Once that relevant, 1964-2003 background to Saturday's calamity is taken into account, our republic's policy-shapers are confronted with a series of questions and answers, of which the following are typical.

1. Is This Risk Necessary?

The future of man's ability to improve conditions on Earth, depends upon results which could not be obtained without the inclusion of manned space-exploration. Also, the protection of life on Earth from dangers, such as small asteroids, demands exploration of near-space to such included purposes.

2. Would More Spent Help to Reduce the Risk of Such and Related Disasters As Those Which Occurred to *Challenger*

and *Columbia*?

If the funds were competently spent for the right purposes, as the case of *Challenger* shows, and as the study of *Columbia's* disaster might also illustrate, more spent for dealing with discovery of known risks, would reduce those risks, and be well worth it.

3. What Kind of Measures Would Be Helpful?

For example. Back during the 1950s, Wernher von Braun warned that travel to other planets, such as Mars, should learn a lesson from Columbus—by sending flotillas of three or so vessels, capable of supporting one or more of the members of the flotilla in case of deadly problems to any one. The same ought to become policy for manned flights to the Moon, and for situations such as that faced by *Columbia*. In general, always anticipate possible catastrophes, even of unexpected types, and build appropriate responses into the system.

4. Why Take the Risk At All?

There are three general reasons for taking the risk: (a) Scientific progress needed by mankind requires this; (b) Such science-driver programs are essential drivers for technological progress on Earth itself, as the results of the Kennedy Moon-Landing mission demonstrated such astonishing benefits to the economy on Earth; (c) Because such activity is required by those qualities of human nature which set the human personality absolutely apart

from, and above the apes.

5. Were the Risks Properly Understood?

Some of the risks were anticipated by some scientists. It was the accounting departments and politicians of similar zeal for cutting expenses, who preferred to see the scientists' protests as politically unrealistic.

Carl Gauss's revolutionary 1799 report on the subject of the fundamental theorem of algebra, points to the importance of the fact that discoveries of universal physical principle can not be found by mathematical formulas; they must be discovered experimentally, by attention to stubborn, seemingly tiny margins of error in the formulas, as Kepler details the original discovery of gravitation in his 1609 *The New Astronomy*. Some of the most important sources of risk, as in the case of the O-ring substitution on the *Challenger*, require intense experimental attention to seemingly small changes in the combinations of technology or materials included in a new design.

Since the essential nature of space exploration is exploring the unknown, relying on simplistic faith in arguably proven design-formulas is intrinsically incompetence. It is what we do not know, which we must always address, otherwise there would be no competent purpose for space-exploration except joy-riding. The accounting department, and certain opportunistic politicians, do not wish to hear of such things; their conceits beg new catastrophes.



Philip Ulanowsky

"The greater mastery of the conditions among the inner orbits of the Solar System, is the immediate imperative for all mankind during the remainder of this present new century." Here, LaRouche confers with members of the LaRouche Youth Movement.

6. How Should Space Policy Impact National Economic Policy?

As the great biogeochemist Vladimir I. Vernadsky has demonstrated, the known universe is composed of three distinct, but multiply-connected phase-spaces: the abiotic; life; and the special mental powers of the human individual, which are the source of original discoveries of universal principles of physical science and great Classical artistic compositions such as John Keats's *Ode on a Grecian Urn*. To understand that universe, and its impact on the condition of life of man on Earth, we must proceed relentlessly to explore to the most distant events and conditions on the largest scale, and also the very, very tiniest. We must explore how the universality of a principle of life operates in even remote and strange conditions of the universe, and address the creative powers of the individual human being similarly.

Man in space presents us directly with all of these phases and their interactions in a concentrated and immediate way. We must overcome a childish fear of the imagined "bogeyman," and go out into the night to discover what is actually there. If we did not do that, we would be less than human.

The growth of brutishly anti-scientific "consumer cultures," and suppression of pro-scientific "producer cultures," during the 1964-2003 interval to date, has been the axiomatic factor which misled the world at large into the present global economic and monetary-financial catastrophe. It is time to return to attitudes on which our earlier achievements, such as the Manned Moon Landing, were premised.

7. The Common Aims of Mankind?

Back during the Fall of 1982, Dr. Edward Teller uttered the most fortunate phrase: "The common aims of mankind." The greater mastery of the conditions among the inner orbits of the Solar System, is the immediate imperative for all mankind during the remainder of this present new century. Later, we shall extend our reach to greater things.

As I emphasized in public addresses I delivered during that same past period, "If we can establish a scientific sub-surface colony on Mars, we can readily transform the Sahara Desert into a habitable region of Earth; and, generally, transform the Earth into the garden it was intended to become under our husbandry."



Letters

Moonification of Science Confirmed

To the Editor:

Thank you, thank you, for your Winter 2002-2003 article, "Moonification of the Sciences: The Russell-Wells 'No-Soul' Gang Behind the Moonie Freak Show," by Laurence Hecht. BRAVO! That is a *tour de force*. It is, by far, the best capsulization of recent history I ever read. I can support much of it from my own earlier sources, and my own personal experiences. I read it at a sitting when it arrived, then re-read it immediately. The balance is revelatory in the extreme. Very disturbing. Couldn't put it down.

I appreciate, particularly, your comments on the RAND Corp., responsible once (an executive thereof, who was incidentally also an associate editor of the foremost aerospace publication in the country) for summarily blocking publication on my LECSO [liquid space optics] technology, in a most snotty put-down fashion. Now, I understand why. . . .

John Bloomer
Discraft Corporation
Portland, Oregon

In Appreciation Of Marie Curie

To the Editor:

Many thanks for the full-sized article on Curie ["Marie Sklodowska Curie: The Woman Who Opened the Nuclear Age," by Denise Ham, Winter 2002-2003]. . . . For those of us over 80, she was a lode star in many, many respects. And congratulations to Denise Ham for her passionate commitment to Curie's memorable accomplishments and life.

Stanley N. Vlantes
Milford, Conn.

P.S. The first U.S. President I remember was Cal Coolidge!

To the Editor:

I liked the long article on Marie Sklodowska Curie. . . .

On page 71, there is a misquote or an error in the caption. The natural nuclear reactor in Oklo is estimated to have operated for about 100,000 years, off and on, depending on when it rained. It started about 2 billion years ago, but did not "operate safely for 2 billion years," as the caption states. The amount of U-235 would have decayed to too low a level to operate for 2 billion years. Also, its operation was "burning" up the U-235.

One other correction: The author states that radon "played havoc with their [the Curies'] equipment and their health" p. 31. The first part is true. The radiation background kept increasing with time. But there is no evidence that radon played havoc with their health. Radon progeny end up in the lungs. Cigarette smokers get about three times the dose to their lungs from radon progeny as non-smokers. There is no evidence that the increased radiation increases lung cancer, but it might. Since Marie did not die from lung cancer, it is likely that her dose from radon progeny was not a health factor.

It was fortuitous that Marie and Pierre did their radium processing in a "barn," so that the radon progeny did not have a chance to build up. Its half-life is about four days, and most of it would have left the building before decaying.

John R. Cameron
Prof. Emeritus,
University of Wisconsin

Editor's Note: Dr. Cameron, a radiation specialist, was awarded the first Marie Sklodowska Curie award by the International Organization for Medical Physics, in July 2000. He is in the process of setting up a Virtual Radiation Museum on the internet, which is temporarily at www.medphysics.wisc.edu/~vrm.

Against Curie

To the Editor:

Madame Curie was a misguided lady who insisted upon overpowering the discovery of John Beard. Beard discovered the cause of cancer, and published the cause and cure of cancer in 1902. He was booed out of the lecture hall. By 1911, there were over 40 clinics in London curing cancer with crude pancreatic extracts based on the Beard Unitarian Trophoblastic Theory of Cancer, which has been

Continued on page 51

A Puzzling Current Loop

Vincent Morin

I recently read two articles published in *21st Century* dealing with the connection between electrodynamics and gravity. One was by Rémi Saumont in Spring 2001,¹ the other by Maurice Allais in Summer 2002.² These papers impressed me, because their authors are great scientists. Especially the paper of Rémi Saumont pushed me to arrange the following simple setup, and observe the strange behavior reported. It should be easy to reproduce, if the conditions I underline are respected.

I made a circuit with 2 mm-diameter enameled copper wire, as this figure shows:

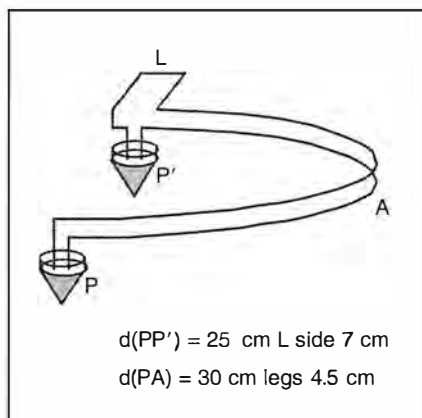

The legs of the loop plunge through the cap of serum plastic conical mini test tubes, with 1.5 ml of mercury closing the circuit.

The side loop, L , passes around the magnetic circuit of a toroidal transformer (a Suprator 180 W, for 220 V, 50 Hz French supply, with 1,700 turns of primary winding). This circuit is thus composed of two copper segments with mercury contacts in pivoting legs, P and P' . These tubes serve as pivots on the table top, the point A being weighted.

When A presses on the plate of a Sartorius MCI RC210D precision balance, it reads 17 g, with no power flowing to the toroidal transformer. If 10 mA

is made to flow in the transformer primary (about 17 A in the weighted loop), 1 g is lost, after some 30 seconds of a seemingly exponential decrease. It is as if the loop weighed less.

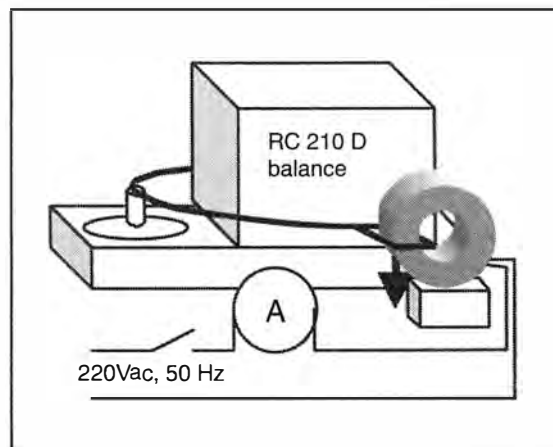

I first sought the cause in a perturbation. I thus isolated the circuit in the middle of a wooden table, and tried to measure with a spring the force shown on the Sartorius. No extension of the spring occurred, although a 1g weight suspended drew the spring about 1 mm longer!

After verification, the same occurred when the circuit was mounted on the Sartorius, but suspended by the spring (ruling out the weighing machine environment as a cause). Later, I found that a very light mirror, positioned in equilibrium on the wire, and a support fixed to the tabletop, produced a perfectly reproducible deviation of a light beam, with the same exponential-like movement.

In conclusion, it is as if the loop weighed less, but only if it is in a very close position to its initial one (less than 100 μm). The Sartorius is a very stiff balance (at full scale of 210 g, the plate moves 230 μm , whence a stiffness very near to 1 $\text{gf}/\mu\text{m}$; the spring with a stiffness of 1 gf/mm is very extensible. Thus, if a force is only existent when the

loop does not move, and decreases quickly when the loop moves some hundredths of a millimeter, it will only be seen on a very stiff weighing machine, and will be unnoticed on every weighing machine which requires the loop to move a small fraction of a millimeter to produce a force measurement.

This observation is very puzzling, and, to my knowledge, there is no conventional explanation of the tendency of a conductor with current flowing inside to apparently lose weight, but only if in close vicinity of its initial locus when current is established. All causes that produce a force unchanged

with a change of position on the order of a millimeter are ruled out (especially convection, or electrodynamic actions from the outside environment).

This observation deserves closer examination, and I am working to determine the force-distance relationship of this phenomenon. Should we ultimately conclude that the mass of the wire is affected, this would be an important new element in comprehending the unification of forces.

The author thanks R. Saumont and M. Allais for their research, and also L. Hecht for his articles about Ampère-Weber electrodynamics.³ The author can be contacted at vincent.morin@univ-brest.fr.

Notes

1. Rémi Saumont, "Anti-Gravity: Myth or Reality," *21st Century*, Spring 2001, pp., 27-39.
2. Maurice Allais, "On a Connection Between Electromagnetism and Gravitation: The Action of a Magnetic Field on the Motion of a Pendulum," *21st Century*, Summer 2002, pp. 34-40.
3. Laurence Hecht, "The Atomic Science Textbooks Don't Teach: The Significance of the 1845 Gauss-Weber Correspondence," *21st Century*, Fall 1996, pp., 21-43.

Was the *Antikythera* an Ancient Instrument for Longitude Determination?

by Richard Sanders

In the wake of our work on the torquetum,¹ there has been renewed interest in ancient, or not so ancient, astronomical instruments. Henry Aujard in France recently brought to our attention one of the most important archaeological finds of the 20th Century (or perhaps of modern times): a very intricate, bronze, geared instrument, known as an *antikythera*, which dates from around 80 B.C. Fragments of the instrument were found in a large shipwreck on the sea floor off the coast of Greece in 1900, by sponge fishers. (See Figure 1.) It is unlike anything else that has been passed down to us, in terms of the intricacy of its more than 30 gears. (We do have a geared astrolabe, but it is from about 1,000 years later!).

The *antikythera* was studied over the years, but the breakthrough came when Derek de Solla Price, a professor of the history of science at Yale University, was able to use gamma-radiography in 1972 to look at the fragments in intricate detail. He presented his analysis in a 1974 article published by the American Philosophical Society,² whose study we have just begun. We are writing this communication to urge others to also study the 1974 work.

De Solla Price must be commended for his scrupulous attempts to decipher the significance of the ratios of the gears, as involving the relative motions of the Sun and the Moon, including the Metonic cycle (in which 19 solar years correspond exactly with 235 lunations). But the outstanding question that, to our knowledge (and we hope to be wrong), no one has asked is: Why would anyone want to fool with the Moon? It is the same question which we confronted in our hypotheses about the torquetum.

So, let us exclude Moon worshippers and religious rituals as explanation. Otherwise, the Moon is useful for tidal information, and for telling fishermen

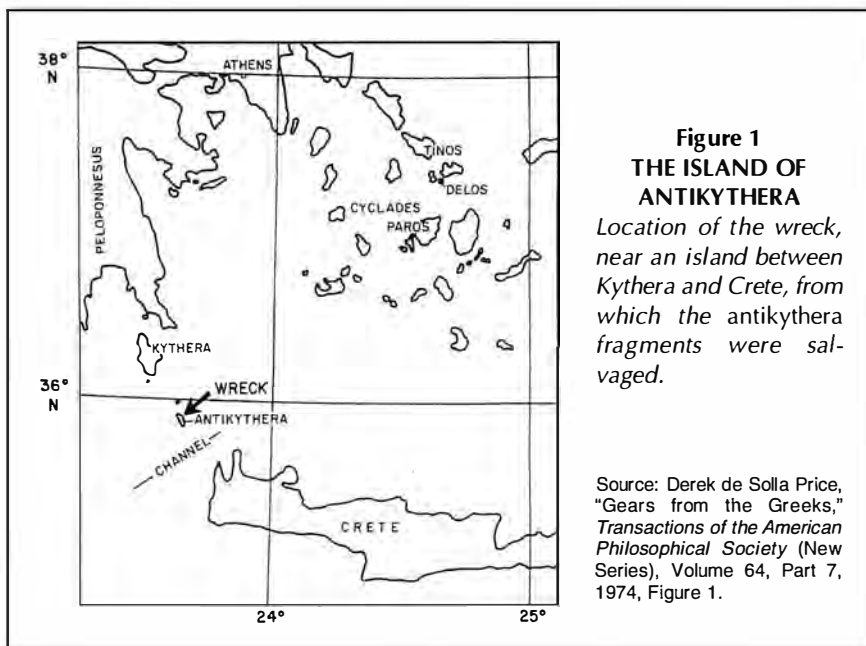

Figure 1
THE ISLAND OF ANTIKYTHERA
Location of the wreck, near an island between Kythera and Crete, from which the antikythera fragments were salvaged.

Source: Derek de Solla Price, "Gears from the Greeks," *Transactions of the American Philosophical Society* (New Series), Volume 64, Part 7, 1974, Figure 1.

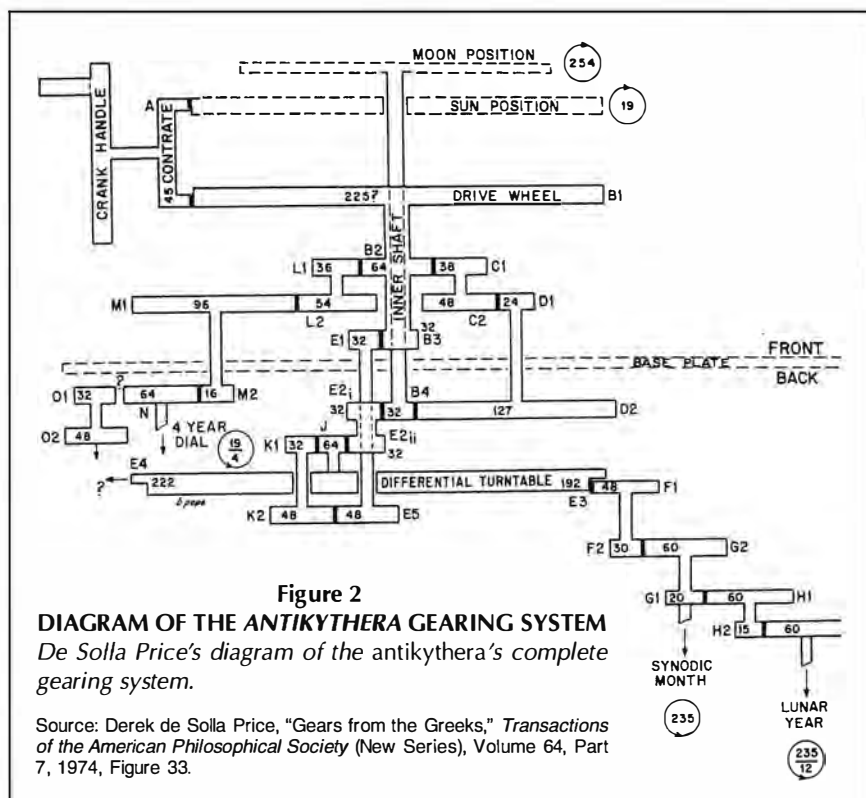

Figure 2
DIAGRAM OF THE ANTIKYTHERA GEARING SYSTEM
De Solla Price's diagram of the antikythera's complete gearing system.

Source: Derek de Solla Price, "Gears from the Greeks," *Transactions of the American Philosophical Society* (New Series), Volume 64, Part 7, 1974, Figure 33.

when the fish are biting, but such information does not justify a "Mount Palomar" instrument such as the *antikythera*, which, after all, was being carried on a ship.

The only reasons for a sailor/navigator to mess with the Moon is to predict eclipses (for finding longitude), and to forecast lunar distances (to find longitude). As we pointed out in the article on the torquetum, if you are using the Moon to determine longitude, you must have with you a book of tables, in which the position of the Moon (for a point of reference), would be given relative to various stars, preferably over 19 years.

The advantage of a geared mechanism, which would have to be set, or be settable, for a given longitude (that

is, reference place), would be that you could dispense with the tables. All you would have to do is crank the handle for the number of days since you left port, and that would give you the longitude of the Moon for that day, for your home base, or place of reference. Then, you could measure the Moon's position relative to some appropriate bright star, and you would know your longitude.

We are putting out this communication to provoke discussion.

Notes

1. See Rick Sanders, "Ancient Navigators Could Have Measured Longitude!" and Bertram Cooper, "Building and Using Maui's *Tanawa*, 21st Century, Fall 2001, pp. 58-65.
2. "Gears from the Greeks," *Transactions of the American Philosophical Society* (New Series), Volume 64, Part 7, 1974, pp. 1-70.

De Solla Price on 'Gears from the Greeks'

Excerpted, with permission, from Derek de Solla Price, "Gears from the Greeks," Transactions of the American Philosophical Society (New Series), Volume 64, Part 7, 1974.

"It seems that the function of the turntable must be to take these two rates of revolution, one annual and the other approximately monthly, and compound them either as a sum or a difference. The two obvious and almost inescapable astronomical choices would be associated with the fact that the synodic motion of the Moon—the cycle of the phases from New Moon to Full Moon—is the difference between the sidereal motions of the Sun and of the Moon against the backdrop of the fixed stars. The Sun appears to rotate through the stars of the zodiac in about 365 days, while the Moon changes place in a period of about 27-1/3 days, and changes through its cycle of phases in about 29-1/2 days.

"Either the differential turntable adds the revolutions of the Sun to those of the synodic phenomena, to

produce the revolutions of the Moon, or it subtracts the revolutions of the Sun from those of the Moon to produce the cycles of the synodic months. From the fact that B3 and B4 rotate in opposite directions (and so therefore do E1 and E2) it follows that it is the latter case which applies. This is confirmed by the gear ratios . . . which introduce numbers compatible with the classical Greek calendrical device of the Metonic cycle, in which 19 solar years are made to correspond exactly with 235 lunations, and therefore with 254 sidereal revolutions of the Moon. The gearing contains wheels that correspond very well with the prime numbers 19 and 127 which are needed to mechanize the Metonic cycle. We have in fact $64/38 \times 48/24 \times 127/32 = 254/19$, so that the differential gear is fed with 254 revolutions of E2 and 19 reverse revolutions of E1. For every 19 (direct) turns of the main drive wheel; this produces 2,356/2 revolutions of the whole differential turntable and all the gears mounted upon it."

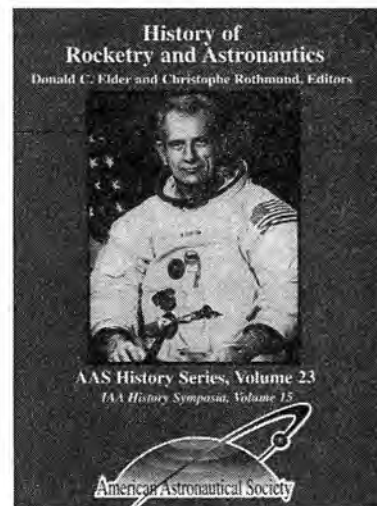

HISTORY OF ROCKETRY AND ASTRONAUTICS BOOK SERIES

AMERICAN ASTRONAUTICAL SOCIETY HISTORY SERIES

For a complete listing of these excellent volumes on the history of rocketry and astronautics, including brief descriptions of each volume, tables of contents of most of the volumes and ordering information, please visit the following pages in the book sections of our Web Site:

- http://www.univelt.com/Aasweb.html#AAS_HISTORY_SERIES
- http://www.univelt.com/Aasweb.html#IAA_PROCEEDINGS_HISTORY_ASTRONAUTICS_SYMPOSIA
- <http://www.univelt.com/htmlHS/noniaahs.htm>

BOOKS ON MARS

These volumes provide a blueprint for manned missions to Mars and a continued presence on the planet's surface, including what technology is required, and what kinds of precursor missions and experiments are required. For more information on the Mars books available, please visit the following page in the book section of our Web Site:

- <http://univelt.staigerland.com/marspubs.html>

If you would like for us to send you more information, then please contact us as follows:

**Univelt, Inc., P.O. Box 28130,
San Diego, CA 92198, USA**
Tel.: (760) 746-4005;
Fax.: (760) 746-3139
E-mail:
76121.1532@compuserve.com
Web Site:
www.univelt.com

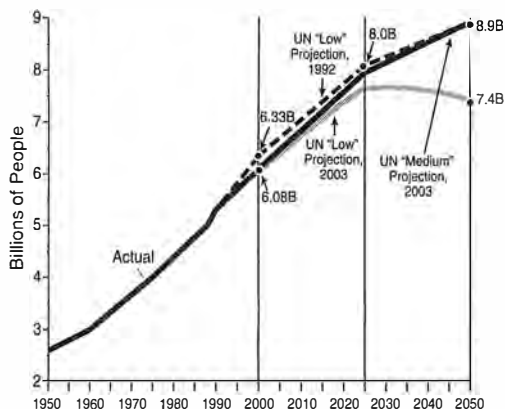

WORLD POPULATION PROJECTIONS FALLING

Compared here is the current U.N. Population Division demographic forecast with that of 1992, at the time of the Rio World Environment Summit, which warned of the “crushing burden” of future population growth. It shows that the supposedly improbable “low variant” of the 1992 forecast is now the most probable “medium variant” of the 2003 forecast of 8.9 billion. In the year 2000 forecast, that figure was for 9.31 billion.



Grote Reber poses with his first radio telescope, built in 1937, and now at the National Radio Astronomy Observatory at Green Bank, West Virginia, where this picture was taken in 1988.

U.N. DROPS POPULATION PROJECTION BY ANOTHER 400 MILLION PEOPLE

United Nations demographers have again lowered their projections for the future human population, this time reducing their consensus guess at the global population in 2050, by 400 million people. Such scaling-down of population projections has become commonplace in the last few years, as the world’s physical economy has sunk into depression. This time, however, in a departure from past forecasts, the U.S. Population Division is pointing to *increased mortality*, or death rates, as an equal cause with falling fertility among women of child-bearing age.

The U.N. demographers have increased their forecast of the number of people who will die between now and 2050, by 200 million, at the same time that they have lowered their projection of the number of babies who will be born by 200 million. The driving force behind this change is the AIDS pandemic, despite the fact that the U.N. agencies continue their 15-year record of *underestimating* the deadly expansion of AIDS. The low-variant of this year’s forecast (see figure) shows population growth ceasing entirely in about 20 years, after which the human population would begin to decline.

FFTF MEDICAL ISOTOPE REACTOR ON BUDGET CHOPPING BLOCK

A ruling to shut down the Fast Flux Test Facility (FFTF), a \$4 billion research reactor near Richland, Wash., will go into effect April 8, unless there is an extension by a federal appeals judge of the injunction against the reactor closure. The FFTF was originally built to test materials for fission and fusion reactors. Community supporters have urged that it be converted to also produce isotopes for medical use. At present, the United States must import 90 percent of medical isotopes used for treatment of cancer and other diseases.

GROTE REBER, INVENTOR OF THE RADIO TELESCOPE, DIES IN TASMANIA

Grote Reber, the American inventor of the radio telescope and the first radio astronomer, died in Tasmania Dec. 20, 2002, just two days short of his 91st birthday. Reber knew radio electronics, and when he learned that radio emissions had been identified coming from space—the work of Karl Jansky at Bell Labs in New Jersey in 1932—he was unstoppable.

He built the world’s first working radiotelescope in his yard in Wheaton, Illinois, in 1937. While designing radio circuits for a living by day, he mapped the radio sky by night. He wrote to professional astronomers, reporting his results and offering his services, but, for the first few years, they showed little interest in departing from traditional, optical astronomy. But before long, Reber had the satisfaction of seeing his work published in *Nature*, the *Astrophysical Journal*, the *Proceedings of the Institute of Radio Engineers*, and the *Journal of Geophysical Research*.

Reber moved to Tasmania, Australia, in the 1950s to continue his pioneering. By then, radioastronomy had become popular, and astronomers worked to detect shorter and shorter radio wavelengths. Reber decided to detect longer wavelengths (150 to 300 meters, 1 to 2 MHz). To do that, he sought regions of the ionosphere where the electron density is lowest, allowing long waves through at times of low solar activity. Tasmania is under one of the two best spots in the world.

Reber was the recipient of honors usually reserved for “professional” scientists, including, eventually, even a medal from the Royal Astronomical Society. His salty article, “The Big Bang is Bunk,” was published in *21st Century* in March 1989, and shows his intellectual independence, as well as his limitations as a thinker. His conclusion was, however, correct.

Reber’s original dish antenna is on display at the National Radio Astronomy Observatory’s (NRAO) Green Bank, West Virginia, site, where his scientific papers and correspondence are archived.

CHINA PLANS 'CHANG'E' PROGRAM OF LUNAR MISSIONS

China is planning a multiphase lunar effort, called the "Chang'e Program," in reference to a Chinese legend in which a young fairy flies to the Moon with her pet rabbit. If the program is approved soon by the government, experts state that the first unmanned mission in the series could be ready for launch in 2005. According to China's chief lunar exploration scientist, Ouyang Ziyuan, this first mission would be a satellite to orbit the Moon, mapping its surface in high resolution and producing three-dimensional images. It would study the elemental composition of the surface and enhance the understanding of the lunar environment, which is important for planning future missions. Phase two would consist of lunar landings and remote-controlled surface rovers. A later spacecraft would land and return samples of lunar soil to Earth.

The proposed timeline is critical, Ouyang said, because "Earth's nearest neighbor probably holds the key to humanity's future subsistence and development." China's lunar program will not be a series of "space spectacles," but a progression of increasingly complex missions, to culminate in making the Moon a second home for mankind.

China's National Aerospace Administration director, Luan Enjie, speaking at an aerospace conference in early March, said that the initial phase of the Chang'e program could be completed by 2010. To minimize costs and development time, he said, the program would largely use existing technology. Luan told *Peoples Daily* in an interview on March 3 that the Chinese Academy of Sciences would receive, handle, and interpret the lunar data.

Most important, Luan stressed that "The Moon contains various special resources for humanity to develop and use," notably helium-3, which is uniquely plentiful in the lunar soil. "It is a clean, efficient, safe, and cheap new type of nuclear fusion fuel for mankind's future long-term use, and it will help change the energy-resource structure of human society."

CHINA'S FIRST HIGH-TEMPERATURE GAS-COOLED REACTOR COMES ON LINE

China's first high-temperature gas-cooled reactor is now fully on line. This is a "major step in China's safe use of nuclear energy to resolve its energy shortage," stated Prof. Wu Zongxin of the Nuclear Energy Technology Institute of Tsinghua University, outside Beijing. The HTGR is of German design, but China designed and produced several of the key components. China has three nuclear power reactors in operation, and four units under construction.

By 2004, China expects to have 4 percent of its energy produced by nuclear power.

SPOTTED OWL REMOVED FROM PROTECTION AS ENDANGERED SPECIES

The U.S. Fish and Wildlife Service determined after a year-long review, that the California spotted owl was not in need of federal protection under the Endangered Species Act, and that there were about 2,200 nesting sites identified in recent surveys. Environmental groups have used the alleged endangerment of the spotted owl to campaign against logging of old-growth forests, and intend to appeal the February 2003 decision.

LONG-DELAYED KRA CANAL PROJECT TO HAVE UPDATED FEASIBILITY STUDY

The first tranche of funds for an updated feasibility study of building the long-delayed canal across the Kra Isthmus in southern Thailand was received on March 5 by the Klong Thai Foundation. The Kra Canal, a more than 400-year-old "great project" of Southeast Asia, would revolutionize the busiest shipping corridors in the world, by linking the Indian Ocean and Andaman Sea to the South China Sea, and on to the Pacific.



CNSA

Bring the Moon's resources to Earth: Luan Enjie, director of China's space agency, speaking at China's 2003 Civil Space Conference and the Preparatory Conference of the Exploration of the Moon.

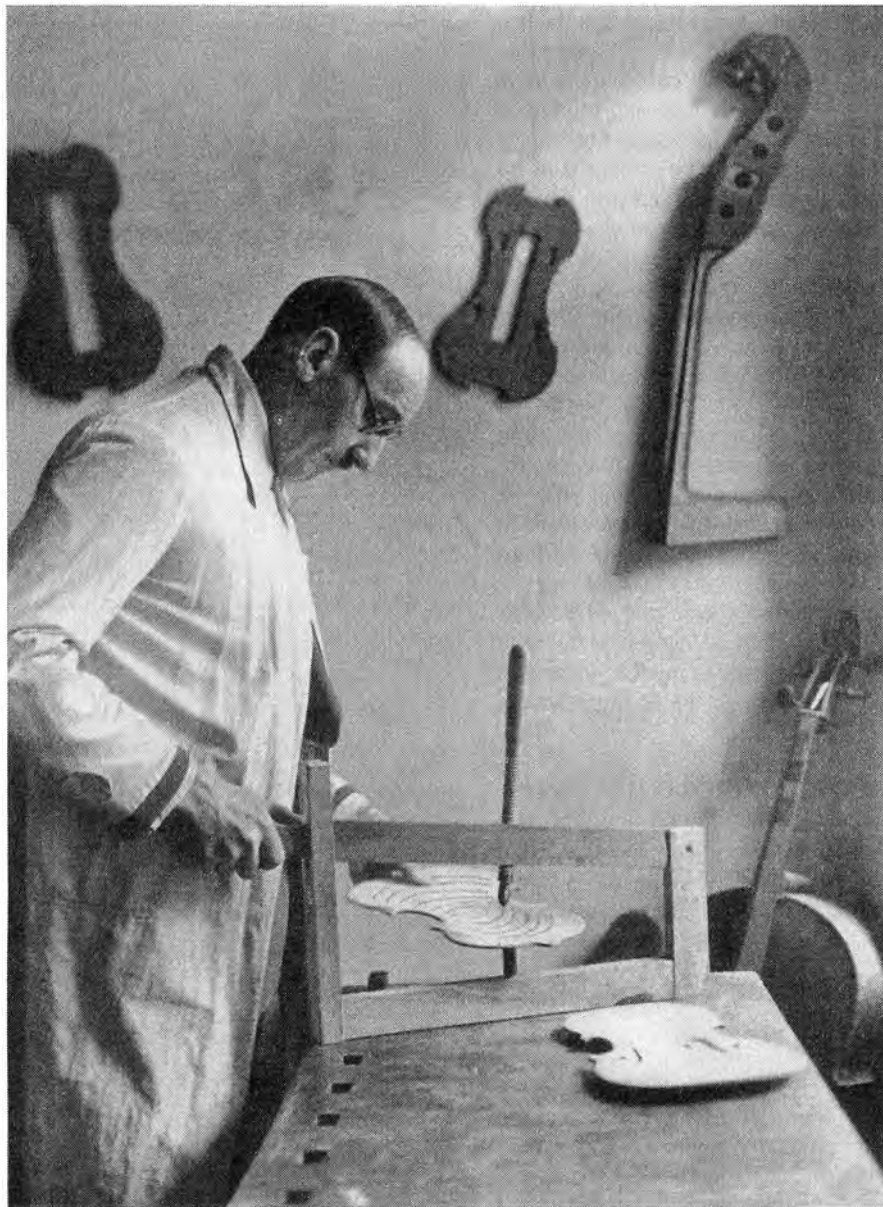

Illustration by Christopher Sloan

An artist's view of the Kra Canal, depicting the canal entrance at the port of Songkhla. A nuclear power plant is in the left foreground. In 1984, the Fusion Energy Foundation and Executive Intelligence Review conducted an economic and financial feasibility study of the canal.

MUSIC AND THE UNSOLVED PARADOX OF PYTHAGORAS

Violin World



Max Moeckel in *Die Kunst der Messung im Geigenbau* (Berlin: Alfred Metzner Verlag, 1935)

The luthier Max Moeckel working on the hole-drilling template.

Intervals in classical musical performance cannot be expressed by a predetermined mathematical ratio, nor can the building of great musical instruments be reduced to a formula.

“A beauty of sound, which knows no bounds,” is how a luthier once described the tone of the old Italian (and Tyrolese) violins. And, in fact, these old violins embody a concept of instrument-building, which culminated in the great masterpieces of Antonio Stradivari, which can fill great concert halls without any effort, and can be heard over the entire symphony orchestra. Their richness of tone ranges from majestic *fortissimo maestoso*, to the sad lament of an *andante molto grave*, up to the outburst of joy *scherzo prestissimo*. The only other instrument that can be compared to them, is the trained human singing voice. Yet all these tones come from a little wooden box about 35-37 cm long for the violin, 42 cm for the viola, and 74-78 cm for the cello.

When you look a little more closely at these handmade masterpieces, you can recognize that this kind of instrument is a triumph of both acoustics and physics. There are many myths in circulation about these “fabulous instruments.” Were the luthiers of old initiated into some secret of the acoustics of physics, which we no longer know today; is there a secret kind of wood, or art of varnishing, which makes all the difference in the sound; or, is there some other kind of secret, relating to how the wood is cut, which had been carefully protected and was lost after the death of Stradivari?

There are still many unanswered questions today about the construction of the violin family (violin, viola, and cello, which all have the same underlying principle of construction), especially after the death of Stradivari, when the great art of creating such wonderful works sank, further and further, into oblivion—and the wildest speculations and most bitter disputes arose. Most of these discussions, however, quite ignore the key question. The Renaissance, the time that saw the birth of this family of

Building and the of Harmonic Sound

by Caroline Hartmann

instruments, was a time of many discoveries, not only in music and instrument-building, but also in painting, the plastic arts, architecture, and machine building. The most significant and many-sided artist and scientist of this time was, without question, Leonardo da Vinci.

The situation in the world of music, and especially regarding musical instruments at the time that we call the Golden Renaissance, provides a number of substantial reasons for assuming that the building of the violin was an invention. The idea for building such an instrument must have sprung from the new discoveries of the Renaissance—above all, from Leonardo da Vinci's investigations into tonality and sound.

However, the Pythagoreans were already acquainted with the paradox, that man recognizes only a few intervals as harmonic, and these intervals, which are heard as harmonic, are created on a stringed instrument by placing the fingers with different spacing between them in each different key. Here, we will pursue this idea somewhat further.

The Unsolved Paradox of Pythagoras

All instruments created by man, use what he has known for thousands of years, that when strings are stretched over a hollow space, more or less beautiful sounds or tones can be created. In India, an instrument of this kind was built around 3000 B.C. Later, Pythagoras (around 500 B.C.), discovered that it was possible to express the relationship between two tones—called intervals—by rational numbers.

Pythagoras invented a one-stringed instrument, a monochord, which the Pythagoreans used for demonstrations, and as a musical instrument. Today, it is used to demonstrate intervals. For example, if you press down on $1/3$ of the length of the string, and then pluck or strike it, the resulting tone will be the interval of a fifth above the tone of that same string when it vibrates freely. The significance of his invention was that man recognizes, or experiences, only a few specific intervals as beautiful. These intervals were called *synphon* by the Pythagoreans, and are the following:

EDITOR'S NOTE

We present this piece as a contribution to the pedagogical effort of the LaRouche Youth Movement, which is presently struggling to master the paradox of the Pythagorean comma. Their crucial, related purpose is to attempt to revive some aging intellects of the Baby Boomer generation, who have denied these youth a future by their immoral abandonment of the principle of truth. Readers may find an audio archive of a panel presentation on the Pythagorean Comma by members of the LaRouche Youth Movement, at the website www.theacademy2004.com (click on "2003 Schiller Institute/ICLC President's Day Conference," on the home page).

This article originally appeared in the German-language *Fusion*, (July-Aug.-Sept. 2002). It was translated into English by Richard Sanders. The author, Caroline Hartmann, is an organizer with the LaRouche political movement in Germany. She plays the violin in the Schiller Institute orchestra.



Anna Shavin (left) and Jennifer Kreingold at the LaRouche Youth Movement panel presentation during the President's Day Conference Feb. 16, 2003 in Reston, Va. Kreingold sang a sequence of natural thirds, to demonstrate that they do not close at the octave.

- Octave (ratio 1:2),
 - Fifth (ratio 2:3),
 - Fourth (ratio 3:4),
- and
- Third (ratio 4:5).

In addition, there is also the 5:6 ratio, which is the minor third.

The Pythagoreans possessed an 8-stringed lyre and kitharra. All the stringed instruments taken as a whole, up to the beginning of the 16th Century—that is up until the invention of the violin family—had the following characteristics, which significantly limited the quality of their sound, and did not leave much room for expressing a variety of the scale's tone colors (for more on this, see Appendix 1):

(1) The fingerboards of these instruments are divided by small ridges, called frets, most familiar to us today from the guitar. The pitch is determined beforehand by these frets, so that for "pure" playing in all the keys one often has to make compromises. Depending on the kind of instrument, there was a certain tempering chosen which allowed for playing in the greatest possible number of keys. One aspect of this, is that the distance from one fret to the next is always different; whence there were naturally many different temperings. When the limits of each instrument's tempering were reached, it had to be retuned, which was the general practice. The discrepancy between the notes sounded on the frets and the proper pitches, as the musician moved through different keys, is sometimes described as the problem of the *Pythagorean comma*.

(2) As for the sound, the resonance chambers of these instruments were for the most part quite flat, or as is the case with fiddles, lutes, or many viols, arched according to certain specific geometrical forms (a cylinder), or with a shape taken from forms in nature. This, from the start, put a limit on the capacity of providing for a "real" or peer-quality accompaniment to the trained bel canto voice. Moreover, the bridge of the instrument is not curved, so that the bow cannot avoid touching all the strings at once, which means that only chords can be played. This kind of limitation can be easily recognized in the accompanying painting of the angel by Fra Angelico (p.19).

The new instrument family of the violin, viola, and cello were revolutionary relative to both these points. The characteristic vaulting curves of these instruments have remained

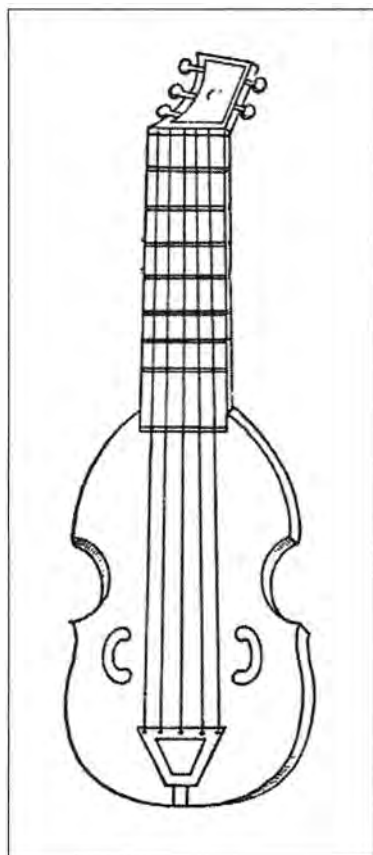

Viola da gamba with frets, from Gerle, Musica, 1532.

unchanged until today, the instruments showing the same proportions down to the smallest detail. Unlike almost all of man's other inventions, this form has stayed unchanged for 550 years.

Moreover, the paradox of the colors of the tonal scale is solved with genius: They simply eliminated the frets, so that the player himself can determine the pitch and how he will play it. Other than the human singing voice, there is no other instrument which allows this. What a revolutionary breakthrough in music! The instrumentalist could finally "sing" with his instrument, as we know today, from hearing the great violin, viola, or cello *virtuosi*. These two points also prove that there is no way that the violin family could have developed stepwise from some other instrument.

The luthier Max Möckel, who worked around the turn of the 19th Century in St. Petersburg and Berlin, did not rest until he had investigated the true origin of the sonorous and architectonic beauty of the violin. His idea was to investigate whether, in the light of the knowledge of the Renaissance, it might not be possible to discover what part had been played by Leonardo da Vinci, Luca Pacioli, and Albrecht Dürer in the revolution in instrument building. Thus, he began to look for clues to support his hypothesis in the works of these great artists, and he came to the following conclusion:

Is there really an Italian secret? Yes and no. If we think of it as some kind of recipe, hidden somewhere in some old chest, then no. . . . We must put ourselves into the time in which the violin was invented, and the ideas out of which each of the old masters created their works . . . The most significant minds, to name but two of them, Leonardo da Vinci and his friend Luca Pacioli, had shortly before concerned themselves, in their work of so many facets, with mathematical problems, and when they saw the triangle and the pentagon, they did not see them as merely simple geometrical figures, but they saw in the pentagon, for example, the secret eye of God, a living sensuous image, with its infinite number of unfoldings, for everything that is becoming.

With this hypothesis as a starting point, Möckel developed a procedure for building the violin, viola, and cello, whose standard was what Luca Pacioli called the *Divine Proportion*. (In the Divine Proportion, the division of a line or a geometrical figure is such that the smaller dimension is to the greater as the greater is to the whole.) From that time on, he built many excellent instruments according to this method.

Lawfulness in Nature

As everywhere in Nature, beauty comes from an inner lawfulness. The famous Italian artist Leon Battista Alberti, who was studied in-depth by Albrecht Dürer, once said:

Beauty is a specific lawful agreement among all the parts, which consists in the fact that you can neither add anything, nor take anything away, nor change anything, without its becoming less satisfying.

Leonardo and his friend Pacioli also knew, that in self-similar

(a) The lute is a perfect egg, from the front and the side view. This curved form is the reason for its tonal possibilities, far exceeding the other instruments.

(b) An angel painted by Fra Angelico, with fiddle and bow. The bridge of this instrument is not curved. Thus, the bow cannot avoid touching all the strings at once, which means that only chords can be played. Moreover, the fingerboard is divided by frets, and the instrument is flat.

(c) The external form of this Lira da braccio is similar to the human body. The belly, on the other hand, is practically flat.

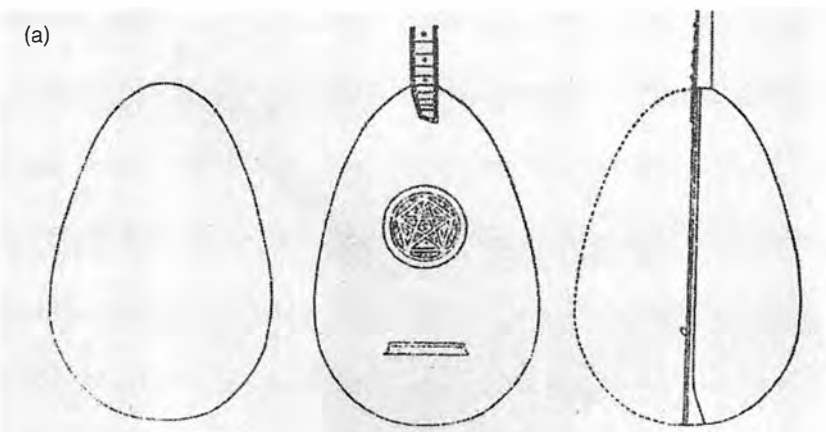

growth processes, you very often find the proportion that Luca Pacioli called “divine” (also called the Golden Section). They also recognized that this was not merely a beautiful principle of mathematical constructions, but the principle of life. Still, the decisive question is: What is the power which creates just this proportion when growth occurs? The luthier Möckel developed a method for adopting this same proportion as the fundamental principle for instrument building.

Nicholas of Cusa, the philosopher-scientist who in his time was in touch with all the great scholars, brought a decisive revolutionary idea along these lines into the scientific discussion: the idea, that all curved lines, such as circles, arcs, and so on, can be expressed through straight lines. In doing so, he created the basis for being able to construct and present curves mathematically or geometrically. Cusa knew what this meant for the further development of music. As he wrote:

Moreover, from the above, the following is established: just as each straight line can be the side of a triangle, a square, a pentagon, and so on, in the same way, one might find an uncountable number of curved lines, which are like unto a given straight line; therefore one can also find angles, which act like a given straight line, that is, as the side and diagonal in a square, or the radius to the circumference of a circle, and likewise in all the planes, which behave as the given straight lines.

Hence it is possible to come to further conclusions, which have until now been hidden not only to geometry, but were also unknown to music and musical instruments, so that to him who will do his utmost to understand it, there will be disclosed in all its clarity, what was absolutely susceptible of being known in geometry, but was not really known. [Nicholas of Cusa, *Mathematische Schriften*]

Leonardo da Vinci, who, as a painter, most painstakingly studied nature and man, was certainly familiar with these new ideas. But he was not only a painter, but foremost, a researcher into nature, an engineer, architect, make-up artist, sculptor, musician, and much more. Above all, he was interested in the inherent lawfulness of Nature. Following the example of Leonardo, the luthier Max Möckel transposed what the Renaissance had learned about the geometrical construction of the human body, to the construction of the violin. The span from the thumb to the index finger of the left hand served him as the standard length (*mensur*) and point of departure. This distance is the *mensur* of the instrument to be built; namely, the distance from the bridge to the end of the resonance box. Möckel’s further geometric construction was based upon two adjacent, upright pentagons, within which hangs a freely float-



The mensur is the distance between the bridge and the upper edge of the violin body.

ing square. From there, he developed three small, right-angled triangles which form the basis for constructing all the other details (see Appendix 2).

Furthermore, in all the instruments of the violin family, we observe a multiple curvature, unchanged for 550 years. One such curvature is recognized from the outside, in the form of the arching of the back and the belly of the instrument. The other is only visible to the luthier. It consists of the curvature of the thickness of the wood. Namely, the wood is thicker near the bridge than it is at the sides, towards which it flattens out. And on the sides, there is a narrow strip of wood which has no variation at all in its thickness.

The extraordinary significance of the curvature of the wood can be easily verified by an experiment with wine glasses. If you take a wine glass which starts out thick and flattens out towards the rim, and strike it, you will create a beautiful, powerful, and enduring sound; if on the other hand, you strike a glass whose thickness does not vary, you will get only an unpleasant "noise," or rattle.

Throughout years of research on many old Italian violins, Möckel ever and again confirmed the proportion of the arched curvature, down to the last detail, from which he derived the idea for his construction. For this he used a method discovered by one of his brothers, Otto Möckel. This was the result of the rediscovery of the so-called "contour circle," found among the tools left behind by Antonio Stradivari, which the old luthiers used to construct regular contour lines, for making the arched curves.

If you were to make a horizontal cut across a mountain range, you would get the contour lines such as those produced by geo-

detic measurements, which show up on topographical maps.

The surfaces of the violin, viola, and cello bodies are irregularly curved everywhere towards their centers, and get more flattened out toward the sides. Of course, the body of the violin is no massive wood plate, in which you could make a horizontal cut, in order to study the interesting arched curves, but it is hollow inside. Two curved surfaces constitute the resonance box of the violin, and it is upon their precise calibration that the quality of the instrument's sound depends. Thus, to study their curvatures, you have to reverse the procedure; you have to take the measure of the vaulting of an instrument previously constructed, and duplicate it by hollowing out a massive wooden board.

Then Otto Möckel "invented" a way of copying the contour lines of all the old instruments. He described his method of working with the peculiar contour circle thus:

It is to be assumed, that . . . they [the old luthiers] positioned the unfinished parts between the circle openings in such a way, that the pencil point would stand at a perfect right angle against the vaulting, and then [they] moved it lightly. Then, [they] move the circle with a light touch around the vaulting that has not yet been smoothed out, and thus black marks would be made only at a certain height, and the resulting curve drawn will immediately show

even to the unschooled eye, all the faults and the wrongly placed contour lines of the vaulting. The mistakes can then easily be rectified, by using a finely adjusted thumb plane to transform the edges and corners of the ugly lines into noble curves. Then the circle, newly adjusted, is brought into action once

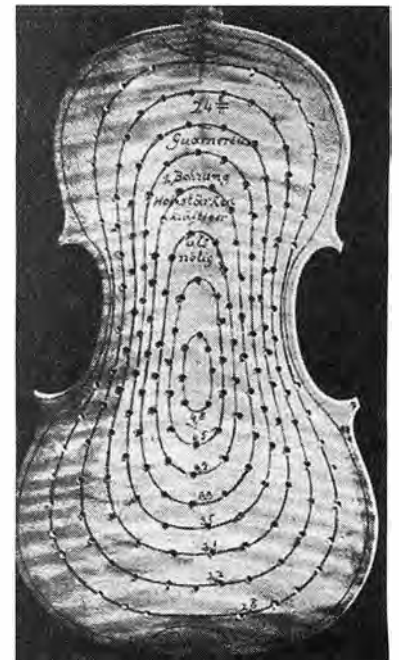

The boring of the vaulting curves. ►

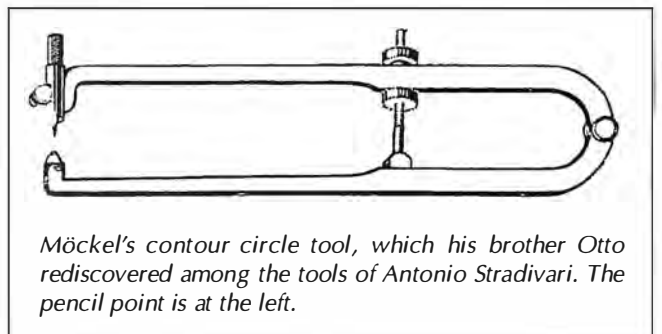

Möckel's contour circle tool, which his brother Otto rediscovered among the tools of Antonio Stradivari. The pencil point is at the left.

again, and the smoothing begins anew. The more curves you draw with the contour lines at different heights, the more the faults will show up.

Thus the construction of the vaulting curves is the basis for the optimal sound distribution over the back and the belly. Luthiers today use Otto Möckel's procedure to copy as precisely as possible the vaulting curves of the old Italian violins.

The Fascinating World of Sound Waves

In order to fully understand the splendid sound of these instruments, however, one must also look at the physics of tonality and sound waves. What is sound, really? What is the origin of the intervals in sound-space, such that we do not recognize all sounds as *synphon*, and what is the source of their creation?

Research into sound clearly confirms the curvature of the old Italian masters as ideal for creating the most powerful, and untrammelled sound, and also for suppressing certain undesirable "wolf tones," or shrill regions of the sound spectrum.

The sound-space itself is "curved" in manifold ways. The many waves of sound which we perceive with our ears as noise or sound, are quite invisible, yet with the aid of experiments, they allow themselves to be visually represented.

We do not know whether or not Leonardo carried out a detailed investigation into the human ear, or hearing per se; but there are many statements in his diaries and drawings, which make one strongly suspect as much. Moreover, there is an outline for experiments, in which he analyzed various kinds of waves, and compared them to one another.

In this research Leonardo compared all kinds of vibrations—light, sound, and magnetism—with one another, in order to discover their similarities. To take this as a starting point, to try to find out what these vibrations might have in common, is still virtually taboo today. Admittedly, in the early 19th Century, André-Marie Ampère recognized that light rays and heat rays were both waves, only distinguished by different wavelengths, and today we know that magnetic and electric rays, X-rays, radio waves, and so on all belong to the same species of electromagnetic radiation. In spite of that, sound waves and water waves have been treated up to now, as if they belonged in a universe with different laws.

Sound and water waves offer a wide field for investigating the phenomenon of waves, and the lawfulness related thereto. The next scientists to investigate waves of all kinds, after Leonardo da Vinci, were the brothers Ernst Heinrich Weber and Wilhelm Weber, as well as Savart, Poisson, and Benjamin Franklin. In the 1825 work *Experimentally Based Wave Theory, or Concerning Waves of Droplet-forming Fluids with Application to Sound and Light Waves* [Wellenlehre auf Experimente gegründet, oder ueber die Wellen tropfbarer Flüssigkeiten mit anwendung auf die Schall-und Lichtwellen], the Weber brothers defined the concept of wave crest, wave trough, wave amplitude, and wavelength (which they called "wave width"), and they investigated interference phenomena especially closely. You could say that they carried on where Leonardo had already prepared the way.

But what actually happens inside an instrument when sound is created? And how is it that waves are spread? Some active power forces the atoms or the molecules of the medium into

motion. In wood, water, the bones of the skull, or the lymph liquids in the ear, or in elastic media, sound waves cause local changes in pressure, and many parts are moved into motion all at once, as if they had received one single blow. The Weber brothers had been inspired by their teacher, Ernst Florens Chladni, to undertake an intensive study of acoustic and musical paradoxes. Chladni himself also had chosen to create—as did Benjamin Franklin—new musical instruments, and for this reason carried out many experiments to try to make visible the motion of waves along a resonance plate. In older physics books, efforts to propagate waves in plates are still described.

In the process of his experiments, Chladni made the following fascinating discovery: Different tones manifest specific characteristics, where some parts move, and some adjacent to them, do not, and it is possible to "see" this. He sprinkled sand onto metal plates, set them vibrating using a violin bow, and then discovered that the sand was formed into various figures on the plates. Depending on the strength of the stimulation, its direction, or its velocity, very interesting sound figures, were formed, demonstrating that sound waves obey specific, peculiar "conditions."

In his works on sound, Wilhelm Weber described Chladni's efforts as follows:

If you take a round piece of paper, with a diameter of about 8 to 12 inches, and stretch it on a ring—or better, stretch a membrane horizontally over a large glass,

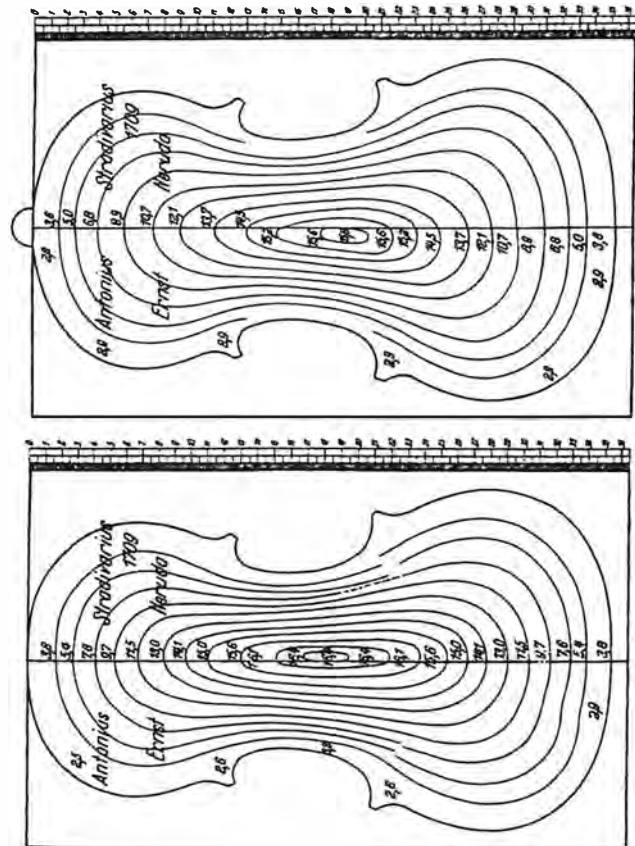

The rediscovery of the function of the contour circles, made it possible to reproduce the vaulting patterns of the old violins. A Stradivarius is diagrammed here.

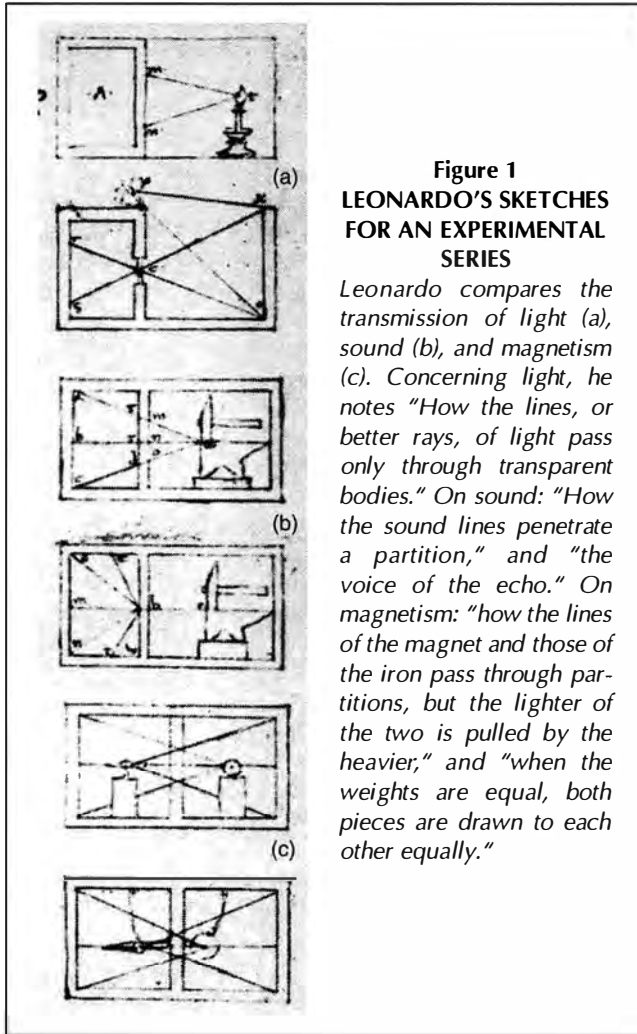

Figure 1
LEONARDO'S SKETCHES
FOR AN EXPERIMENTAL
SERIES

Leonardo compares the transmission of light (a), sound (b), and magnetism (c). Concerning light, he notes "How the lines, or better rays, of light pass only through transparent bodies." On sound: "How the sound lines penetrate a partition," and "the voice of the echo." On magnetism: "how the lines of the magnet and those of the iron pass through partitions, but the lighter of the two is pulled by the heavier," and "when the weights are equal, both pieces are drawn to each other equally."

which has a stem and base, strew sand on it, and bring a sounding piece of glass near it, about 4 to 8 inches away—then the sand arranges itself into lines, which often form perfectly regular figures. . . . As shown by Chladni, to bring out these kinds of waves, you have to hold the membrane down in several places, for example, at two points of the edge and one on the surface itself . . . the membrane is placed horizontally. . . . Table V., Figs. 6 to 18, present the most regular figures [some of these are

shown in Figure 2, below] which are formed upon the moderately vibrating membrane. Where the membrane is not completely taut, then at times a large number of sand lines appear, such as shown in Figure 19, intersecting one another, which seem to originate from the crossing of the circular lines with the diameter lines. [Wilhelm Weber Werke, Vol. I, pp. 113-114]

Today, research of this type is going on to try to make visible the wave action on the back and the belly of violins. Laser holograms are also being used to be able to see the vibrations of guitars.

Otto Möckel described the significance of Chladni's research for the understanding of sound-space:

Chladni has now succeeded in making his sound figures visible on freely vibrating round, rectangular, and oval plates. The figures he has discovered, are produced in rich and abundant fullness, when a bowed instrument is played (or, for that matter, any instrument that has a resonance box), and sections of a surface vibrate in continuously changing multiplicity. It is known that each tone, when its vibrations are transferred through a medium to a membrane or to a resonance box, divides the vibrating surface into various parts (depending on its frequency), which do not participate in the movement. . . . Should one draw the vibration waves which are made by various musical instruments, the beauty of these forms would enchant the eyes. All creation of waves—it does not have to be on a musical instrument—contribute to this infinite sea of vibrations. It is not even necessary to have a good imagination to visualize this surging wave painting. We throw a rock into a still pond, and are happy with the circle, that spreads out and surprises us in the uniform round dance of its waves. Now, think of this circle transformed into a sphere, which is continuously increasing in size and intersected by other spheres, without losing their form. In each sphere is a mid-point, the wave-creator, which forms new waves more complex in curvature. That is the soundless matter, in uncanny stillness, which is summoned to allow an invisible miracle of beauty to come into being in rich abundance. These waves are not meant for the eyes, but for the ear. . . . [Otto Möckel, *Die Kunst des Geigenbaus*, pp. 114 and 189]

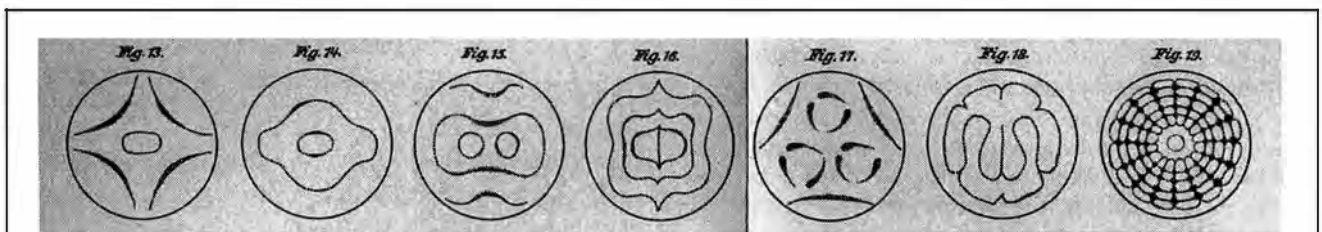
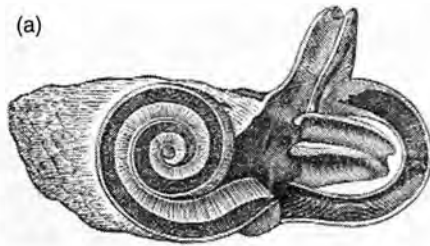

Figure 2
WILHELM WEBER'S SOUND FIGURES

Following Chladni, Wilhelm Weber spread sand on a round piece of paper which he allowed to vibrate. He thus produced characteristic sound-figures, which can be created in the same way on the body of a violin or guitar.

(a) The bony labyrinth in the petrous bone of the skull: at right is the equilibrium apparatus with its three semi-circular canals; on the left, the cochlea (snail) of the inner ear.



(b) Cross-section through the cochlea (snail).

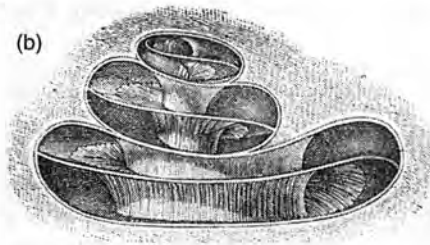

(c) Representation of the basilar membrane of the inner ear stimulated by a sound wave.

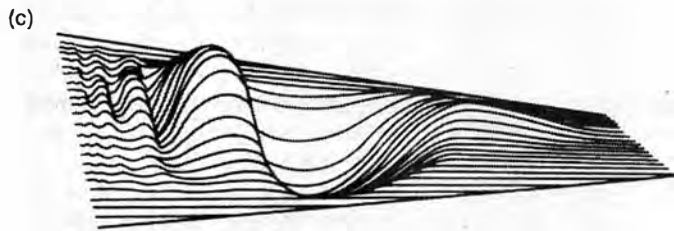

The crown of the violin shows the same snail pattern as the cochlea of the inner ear.

The Human Ear and the Idea of Multiple Curvature

How does the human ear actually hear these phenomenal wave-figures, whose most distinguishable sound-figures the eyes can see? Here a surprising fact comes into play, where once again the relationship which Leonardo and Pacioli so significantly called the *Divine Proportion*, plays a role: namely, that the inner ear is formed like a snail.

In the cochlea (snail), vibrations that strike the eardrum are transmitted by the ear ossicles (hammer, anvil, and stirrup) to the inner ear, and sound vibrations in the air are transformed into signals in the nervous system. This coupling between sound energy and nerve impulses is well known; however, we know very little about the way this variety of information, or impressions upon the nervous system, is processed.

The great significance of the cochlea should also be clear by its being located (together with the labyrinth, the organ that governs our sense of equilibrium), within the petrous bone, the hardest bone in our body. It is a system comprised of three different coiled tubes, placed side by side: the *scala vestibuli*, the *scala media*, and the *scala tympani*. The *scala media* is filled with a fluid called endolymph, which is high in potassium and low in sodium, in contradistinction to the perilymph present in the *scala vestibuli* and *scala tympani*, which has exactly the opposite composition. This difference creates an electrical potential between the two liquids. Between the *scala media* and the *scala tympani*, there is a fibrous membrane, called the basilar membrane, on which the hair cells are to be found. These cells act as very sensitive sensors, transmitting the sound waves entering from without, in such a way that the membrane begins to vibrate in three-dimensions. High notes tend to stim-

ulate primarily the hair cells at the opening of the basilar membrane, low tones stimulate the hair cells at the other end. The electric currents that arise are transmitted by nerve fibers connected to the hair cells, along the auditory nerve and to the brain.

It is more than symbolic that Man's auditory organ should be in the spiral form of a snail shell, given the lawful connection between music and geometry. What other explanation could there be for the snail's playing such a significant role as the head of the violin, from the beginning of the 16th century until today? Why has it become practically a standard form—as a three-dimensional ornament, going from the peg box, to a sculpted scroll which gets steadily wider, so that its greatest breadth is reached at the midpoint of the snail? After all is said and done, the snail forms the crown of the new family of instruments, the violin, viola, and cello; perhaps it strengthens the waves or acts as a wave-guide; one thing is certain: it expresses the inner lawfulness of the construction of the instrument.

Bibliography

- Ernst Florens F. Chaldni, 1827. *Kurze Übersicht der Schall- und Klanglehre, nebst einem Anhang die Entwicklung und Anordnung der Tonverhältnisse betreffend* (Mainz: B. Schoot's Söhne).
- Albrecht Dürer, [1908]. *Unterweisung der Messung*, neu Herausgegeben von Alfred Pletzer (München: Südeutsche Monatshefte GmbH).
- Leonardo da Vinci, [1953] *Tagebücher und Aufzeichnungen* (Leipzig: Paul List Verlag).
- Georg Eska, 1997. *Schall und Klang—Wie und was wir hören* (Basel: Birkhäuser Verlag).
- Max Möckel, 1925. *Das Konstruktionsgeheimnis der alten italienischen Meister—Der Goldene Schnitt im Geigenbau* (Berlin: Verlag der Musikinstrumenten-Zeitung Moritz Warschauer).
- _____, 1935. *Die Kunst der Messung im Geigenbau* (Berlin: Alfred Metzner Verlag).
- Otto Möckel, 1930. *Die Kunst des Geigenbau* (Leipzig: Verlag v. Bernhard Friedr. Voigt).
- Fra Luca Pacioli, [1889]. *De Divina proportione—Die Lehre vom Goldenen Schnitt*, Constantin Winterberg (Wien: Verlag Carl Graeser).
- Bartel Leendert van der Waerden, 1979. *Die Pythagoreer* (Zurich: Artemis).
- Josef Wechsberg, *Zauber der Geige*, (Frankfurt: S. Fischer-Verlag).
- Grosses Lexikon der Musik*, 1968. Abschnitt über Musikinstrumente von Emmanuel Winternitz, Norman Lloyd (Genf: WPI).
- Emmanuel Winternitz, 1974. "Leonardo da Vinci and Music," in Ladislao Reti, *The Unknown Leonardo* (New York: McGraw Hill).

APPENDIX 1
ON THE CAUSES OF THE DIFFERENT COLORS OF THE SCALE

'A Completely Pure Music Is Absolutely Impossible'

The researcher Ernst Florens Chladni (1756-1827), teacher of the famous physicist Wilhelm Weber, explained why "pure" music is not possible:

In whatever kind of *tempering* you might choose, a small deviation from the general purity of the tonal relationship, is *indispensable*—not only for instruments with a fixed pitch, as many believe, but in general. The reason for this lies in the nature of the number relationships themselves, such that, if you want to assert each tone purely against the fundamental, they will not have a pure relationship to each other, and if you want to give to each tone a pure relationship to the one preceding and the one following, then the relationship to the fundamental is lost. A completely pure music (that is, where each fifth is equal to 2:3, each major third is equal to 4:5, each minor third is equal to 5:6, and so on) is thus absolutely impossible, even if one were to stay within one diatonic key, but also if you wish to distinguish all the raised and lowered intervals precisely. [*Kurze Uebersicht der Schall und Klanglehre* (Brief Overview of the Science of Sound and Tonality), p. 12]

In this context, look at the following example: If one presents the individual steps of the scale, *g, a, b, c, d, e, f#, g',* and *a'* (*a'* is added here for purposes of demonstration) as frequencies with the smallest whole numbers, 24, 27, 30, 32, 36, 40, 45, 48, and 54 Hz, immediately one comes up against the following difficulty: The frequencies are so chosen, that *g-b-d*, as well as *c-e-g'*, and *d-f#-a'* form a major triad, that is, the first interval of these triads (*g-b, c-e, and d-f#*) is in the ratio of a major third (4/5), and the intervals *b-d, e-g',* and *f#-a'* are in the ratio of a minor third (5/6) to each other. Each of the cited triads gives the ratio of 2/3, thus a fifth. But it is not possible to form a fifth on the tone *d* within the same scale.

If, using that same *d* as a starting point, you would use the same tones to form the *d*-minor or *d*-major scale, the result would sound quite impure to the ear. The relationship $a/c = 27/32$ is neither a major nor a minor third (that is, neither



The author with her violin.

4/5 nor 5/6); nor is the ratio $a/e = 27/40$ a pure fifth, but slightly larger. The ratio of a pure fifth to *d*, should be 27:40.5. But that is too low for the *d*-scale (minor or major).

In musical praxis, it is shown that the ear (or the human spirit) knows very well how to deal with this paradox, and even to utilize it *creatively*. It continuously, and *as much as possible*, smoothes out the little "impurities" or "ambiguities," which arise from the above-cited phenomenon of the difference in keys. This is difficult to do with instruments whose pitch is fixed, but on the violin, viola, or cello it is very easy. The "fitting," or "tempering," means that for the purpose of overall musical harmony, the ear abandons the absolute arithmetical "evenness" of the same tones. The decisive reason for this was discovered by Leonardo da Vinci. The ear hears the music not as single notes;

rather the music is apprehended as intervals, not as notes. Leonardo wrote:

Each impression endures momentarily in the object receptive to it; but the stronger impression will be held longer, and the weaker, shorter. I call *receptive*, in this case, any object which is changed from its original situation by any kind of impression whatsoever, and *unreceptive* that object, which might indeed have been changed from its original situation, but it fails to retain any impression of what it was that moved it. Receptive is the condition when a blow is impressed upon a sounding object, such as when bells and the like are struck, or sound in the ear. Were this impression of tones not to endure, then a one-voiced song would not have a beautiful sound: for when you go quickly from the first note to the fifth, it is as if you hear both tones as the same time, and therefore, you hear the harmony which the first makes together with the fifth. But if the impression of the first were not to remain for some time in the ear, then the fifth, which follows right after the first, would sound alone. And since one tone alone cannot form a harmony, such a one-voiced song would not be beautiful. [Leonardo da Vinci, *Tagebücher und*

g	a	b	c	d	e	f#	g'	a'	b'
24	27	30	32	36	40	45	48	54	60

THE TEMPERING PARADOX

Here is the scale of g, assigning to the frequencies the least possible whole numbers, which allow for the formation of the harmonic intervals—the fifth, fourth, minor and major third—in relation to the fundamental frequency.

$g/d = 24/36 = 2/3$ (pure fifth)
 $d/a' = 36/54 = 2/3$ pure fifth

but:

$a/c = 27/32 \neq 5/6$ (not a minor third)
 $a/e = 27/40 \neq 2/3$ (larger than a pure fifth)

The great task when building instruments, still today, is to accomplish the most “precise” possible tempering, which comes the closest to the human ear. The “working process” of the human ear must become reconstructible, in order to make the most beautiful music possible. Before the invention of the violin, viola, and cello, that was not so easily done, because the notes of plucked or bowed instruments were predetermined by the frets. Thus, each time musicians playing well-tempered music wanted to shift keys, they had to retune their instruments.

APPENDIX 2 DIFFERENT COLORS OF THE SCALE

The Construction of The Violin’s Vaulting Curves

The luthier Max Möckel based his construction of the vaulting curves, as well as the gradient of the thickness of the wood of the violin’s back and belly, on the Golden Section. Here is his construction for the gradient of the thickness of the wood.

Let us consider the square $PQXY$ (Figure 2), within which the fundamental form of the violin is enclosed, consisting of three small rectangles. The perpendicular bisector of this square is exactly the same length as the air-space of the violin’s body. Let us call this perpendicular bisector ML , and the horizontal line perpendicular to it, NO . Thus, two rectangles are formed, $PQON$ and $NOYX$. Now we must divide the vertical lines PX and QY according to the Golden Section. The result is a large segment PK , and a small segment KX , as well as the large segment XI and the small PI . Similarly, we divide the side QY

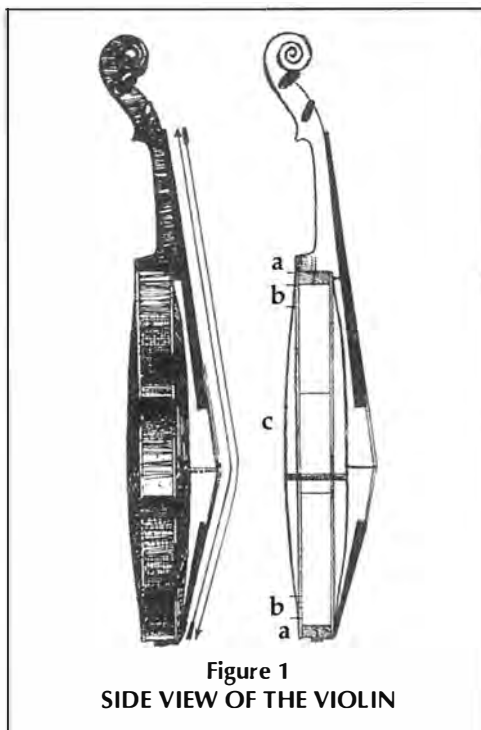

twice into the proportion of the Golden Section: QH is the larger and HY the smaller part of one division; for the second, YG is the larger, and GQ the smaller. This process is necessary because we have to find the center of each circle, which will provide us with the curves for the gradient of the thickness of the wood for the back and the belly of the instrument.

Let us now connect the points K and H with M , and the points G and I with L ; through which intersections the points marked 3 and 4 are obtained. Now, if we draw within the upper rectangle $PQNO$, the diagonals NQ and OP , we get the point of intersection marked 1. The diagonal connection between point 3 and Y (the corner of the square), and of point 4 with X , then gives us the intersection point 2. Points 1 and 2 are centers of circles crucial for the entire further construction.

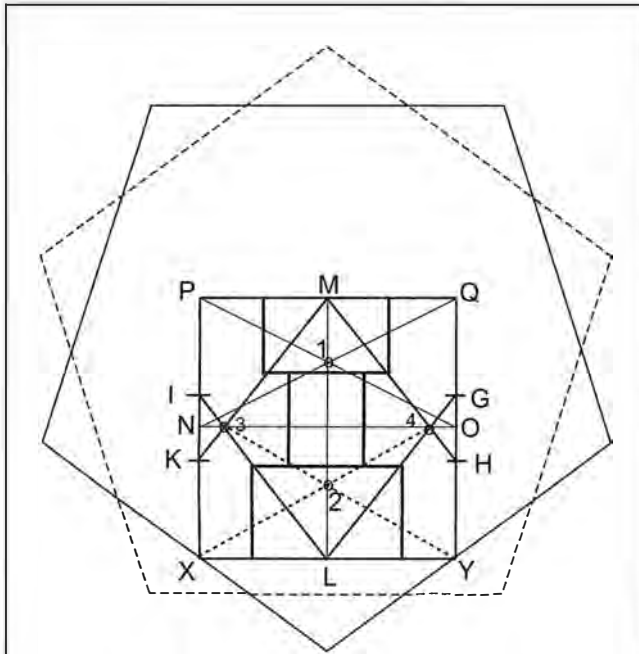

Figure 2
GOLDEN SECTION CONSTRUCTION

The first step in the construction of the wood-thickness gradient within the initial pentagon. The relationship of the diagonal of a pentagon to its side is in the golden section or golden proportion.

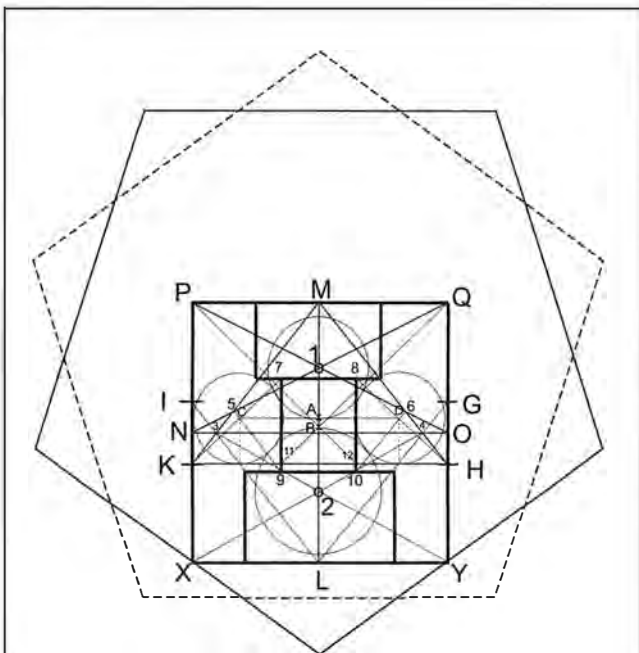

Figure 3
DETERMINING THE PROPORTIONS OF THE VIOLIN
The first four auxiliary circles are determined.

As evident from Figure 3, KM and NQ intersect at point 5, and the lines OP and MH at point 6. Now, if we connect point 7 to K , point 8 to H , point 5 to 9 and 6 to 10, we obtain intersections C and D , which, likewise, will be centers of important circles. We still have to discover the radii of these four circles.

To that end, let us first draw a horizontal line between C and D , which cuts the perpendicular bisector at point A . The line that connects A to point 1 is then the radius of the circle whose center is 1. The horizontal line HK cuts the two vertical lines of the middle rectangle at points 11 and 12, which we connect diagonally with the corners of the square P and Q . These diagonals cut the perpendicular at point B . The connection between B and point 2 is the radius of the circle whose center is at 2.

Now, if you drop perpendiculars from points C and D to the horizontal line, HK , you will get the radius of the circles around C and D . With proper construction, these circles will be tangent to the other circles around 1 and 2.

Now, let us construct the curves of the thickness gradient. If we extend the horizontal line CD on both sides until it intersects PX and QY (Figure 4), then the straight lines VE and WF will be radii of the circles around E and F . These circles show some overlapping with the preceding ones. The gray shaded area is the outline of the resonance plate to be worked on later.

The resonance plates are then cut out according to the outline produced in this way. What next? How would they look in cross-section? Max Möckel investigated countless old masterpiece violins, and noted the following: First, all the instruments are "flat" near the edge, where there is no curvature of

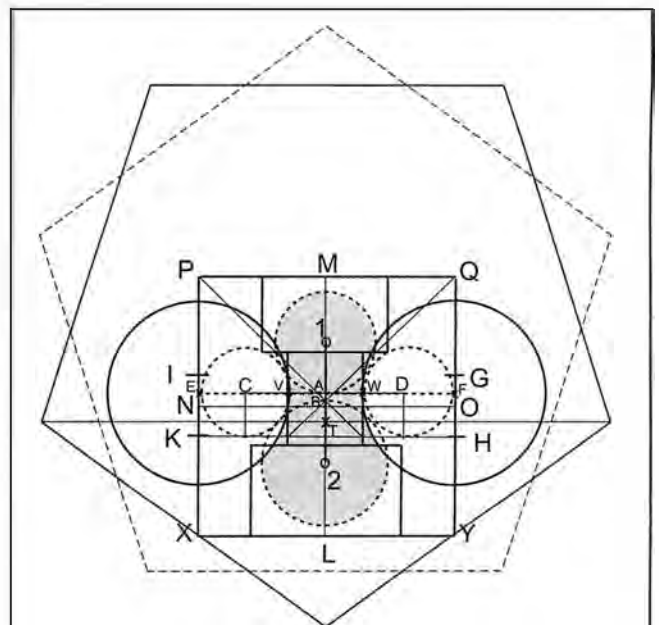

Figure 4
DETERMINING THE RESONANCE PLATES

The four circles, which determine the domain of the resonance plates whose wood-thickness gradient is to be constructed.

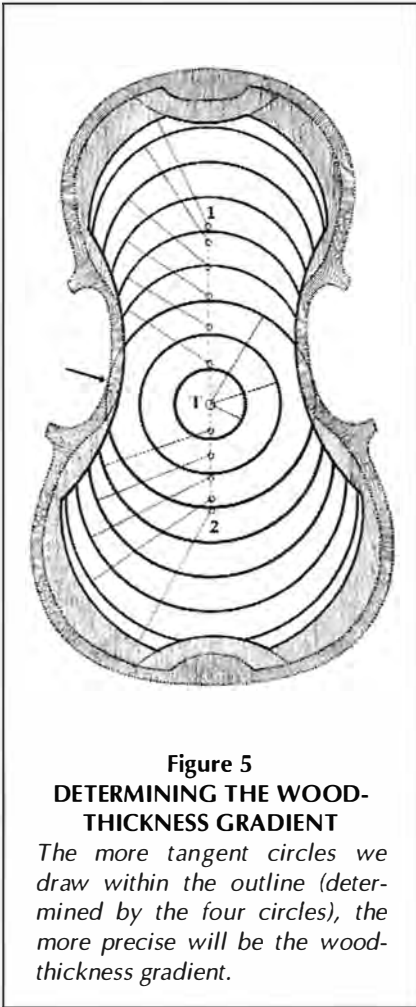

Figure 5
DETERMINING THE WOOD-THICKNESS GRADIENT

The more tangent circles we draw within the outline (determined by the four circles), the more precise will be the wood-thickness gradient.

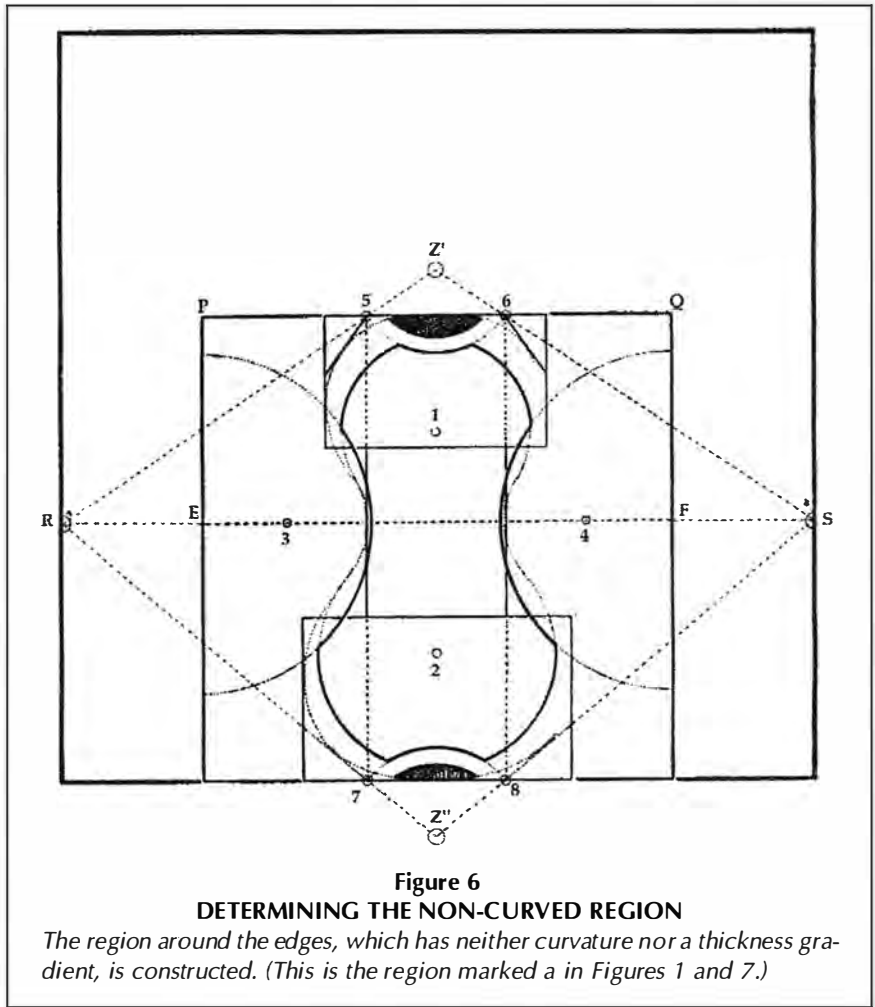

Figure 6
DETERMINING THE NON-CURVED REGION

The region around the edges, which has neither curvature nor a thickness gradient, is constructed. (This is the region marked *a* in Figures 1 and 7.)

either the back or belly, nor any gradient in the thickness of the wood (Figures 1 and 5).

Second, the maximum thickness of the back and the belly are related to each other according to the Golden Section proportion. Möckel remarked about this:

It is a fundamental rule, that the mutual relationship of the thickness of the back and the belly, must always be set. This is how the difference between the vaultings of the back and the belly is always tempered in an ideal manner. It is in the relationship, of the thicknesses of the one to the other, where the main secret of the classical Italian masters lies, to my knowledge, in the determination of the relationship of the thickness of the one to the other, and this is, moreover, a splendid explanation for the many different gradients of wood-thickness, which we find in the old Italian master-works. [Max Möckel, *Kunst der Messung*, (Secrets of Construction), p. 98 ff.]

How is it possible to bring about a lawful gradient in the thickness of the wood? To that end, let us consider the region shaded in gray in Figure 4. Let us mark in the diagonal which runs across the lower part of the pentagon, and call it the

measure line. The intersection of this diagonal with the perpendicular bisector, we call *T*. Now, we draw three concentric circles around point *T* (Figure 5). The diameter of the smallest circle must be equal to the width of the bridge. (Möckel has explained the reason for this elsewhere; here we will just assume it.) The largest circle is the tangent circle to the outer edge (Indicated by the arrow). The middle circle around *T* can be drawn arbitrarily, somewhere between the largest and the smallest circle.

Using as centers any arbitrary points, as long as they lie between points 1 and 2 and the perpendicular bisector, draw circles which are tangent to the outer edge of the violin. The more such circles we actually draw, the smoother the gradient of the wood thickness, which is the greatest at *T*, and decreases going outward. The circles around points 1 and 2 give the upper and lower limits of the white zone in Figure 5.

Lastly, we still have to determine what to do with the belly and the back areas, how in fact they are to be vaulted relative to their outer form, as well as to their inner thickness gradients. To that end, we extend the horizontal line of the small square *PQXY* out to the edges of the large square (Figure 6), and connect the end points *R* and *S* with points 5 and 6, and 7 and 8, respectively.

The intersection of these diagonals above and below the body of the violin, at Z' and Z'' , are, in turn, centers of circles with the radii $Z'5 (= Z'6)$, or $Z''7 (= Z''8)$. These circles cut a small arc from the shaded inner surface at the top and the bottom. By using the circles that we construct-

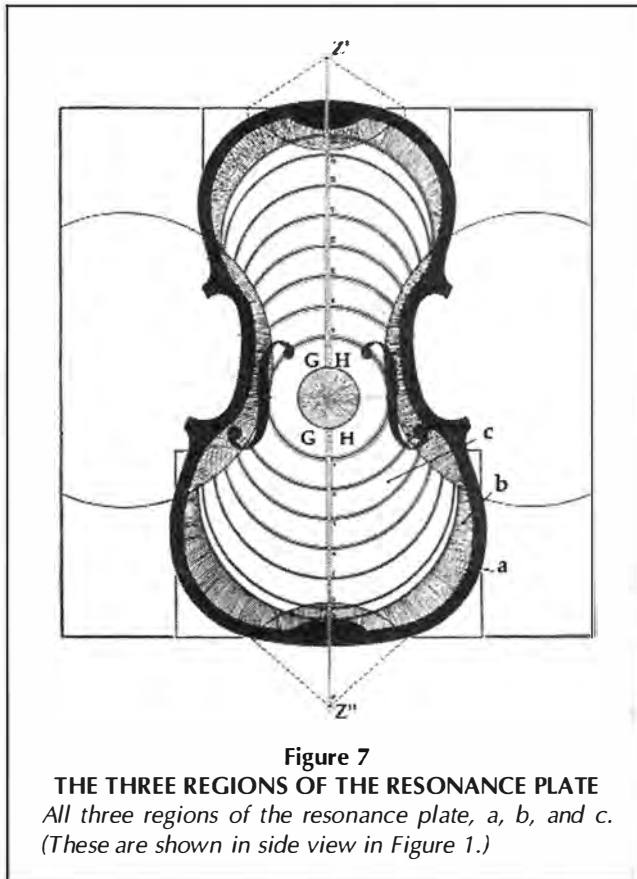

Figure 7
THE THREE REGIONS OF THE RESONANCE PLATE
 All three regions of the resonance plate, a, b, and c. (These are shown in side view in Figure 1.)

ed previously around E and F , which had already outlined a part of the basic form, we now have created three different surfaces upon each plate of the body of the violin (Figure 7).

- The black portion shows the edge of the back and the belly, which remains flat. The ribs (as the surfaces that make up the side of the violin are called) and the corner blocks are glued onto these.
- The gray cross-hatching marks the surface between the edge and the inner part, where the thickness of the wood is not precisely determined prior to the actual finishing, but blends in naturally.
- The white inner part is divided by circular curves, and shows the specific surfaces to be worked on, whose thickness is shown by the points marked.

Using this method, Möckel determined the maximum thickness of the wood for the belly and the back. The straight line GH is the thickness of the belly. This is indicated above and below the small circle in the middle. Now, when we connect G and H above with Z' , and connect G and H below with Z'' , we get two elongated, narrow wedges. They are different from each other, and show the gradient of the thickness of the wood of the belly. You can see that the wedge which runs a longer distance to the top of the instrument, is slightly narrower than the lower, shorter one; this indicates the different thickness gradients (Figure 7).

Möckel said the following about this:

The difference might be small, but it is once again a proof that it is impossible to copy the thickness of the wood without really knowing the construction. The failure, when it comes to tonal quality, of the so-called exact copies, derives most of all, from this fact. [Max Möckel, *Kunst der Messung*, (Secrets of Construction), p. 59]

Ben Franklin

BOOKSELLERS

"We come to *know* a principle, as distinct from *merely learning* to mouth a politically correct verbal formulation of a mere doctrine, by *reenacting the mental act of discovery*. A student is able to relive the thought-process of original discovery within the sovereign domain of the individual mind of the discoverer as much as thousands of years past."

Lyndon H. LaRouche, Jr.
 "The Classical Principle in Art and Science"

Works by Lyndon H. LaRouche, Jr., his associates, and the living Classics of Science, Music, Art, Philosophy, Statecraft, and Literature

- 10% discount for 21st Century readers! •

Visit our on-line catalogue at
www.benfranklinbooks.com

or write

Ben Franklin Booksellers, Inc.
 P.O. Box 1707 Leesburg, VA 20177
 (703) 777-3661 • (800) 453-4108
 Fax (703) 777-8287

e-mail:
benfranklinbooks@mediasoft.net

The 'Solar Jerk,' The King-Hele Cycle, And the Challenge to Climate Science

by Rhodes W. Fairbridge

A senior Earth scientist divulges some little-known discoveries in planetary dynamics, and how they may affect Earth's climate.

During the Cold War, one of those mysterious scientists known in Britain as "boffins," was D.G. King-Hele, located at the Royal Air Force research labs at Farnborough. His early work was, unfortunately, buried under security labels, but in the last few decades the lid was lifted (somewhat), and in 1975, he published a delightful essay in the Kepler volume of *Vistas in Astronomy* (Vol. 18), entitled "From Kepler's Heavenly Harmony to Modern Earthly Harmonics. . ."

Earlier, in 1966, he had stuck his neck out (in *Nature*, Vol. 209) with a brief item entitled "Prediction of the Dates and Intensities of the Next Two Sunspot Maxima." How on Earth was this approached? By looking at the planets—not at the terrestrial effects, and not, astonishingly, at the Sun.

The motions of the planets and their study takes us back to the time of Kepler and Galileo. Then, in the second half of the 20th Century,



Photo above shows a currently eroding intertidal notch at Kapapa Island, Oahu. Photo below shows an underwater formation of similar shape, 24 meters below the surface along the Kaneohe, Hawaii, shoreline. This is an example of the many types of evidence that tell geologists of long-term climate change. In this case, the clues suggest the rapid rise in sea level, produced during the glacial melt which began at the end of the last Ice Age, some 18,000 years ago.

Source: *Journal of Coastal Research*

came rocketry and the possibility of space exploration. This called for advanced formulations and computational skills. Here, NASA and the Jet Propulsion Laboratory in Pasadena, California, enter the picture. The Russians, naturally, did the same thing, and some of them managed (through the Czechs) to keep in touch with the Americans.

Each planet requires its own time-table and space geography. The computational challenges were mind-boggling, but they were conquered. Armed with the thus created new ephemeris (the planetary time-table), two Columbia University retired professors of geology, John Sanders and this writer, were able to prepare a planetary framework for the explanation of terrestrial climate. It was presented in a volume entitled *Climate: History, Periodicity, and Predictability*, edited by Michael R. Rampino (New York: Van Nostrand, 1987).

The planetary framework did not appear fully formed, like Botticelli's *Venus on the Half [Pecten] Shell* on the shore of Cyprus (a temple marks the spot). Many famous astronomers had given much dedicated thought and time to the subject. In 1801, the Astronomer Royal in Britain, Sir William Herschel, discussed the nature of sunspots, their variability, their effect on climate, and the positions of the planets as possible causative forces. Although this work was published by the Royal Society, it was "ahead of its time." Some century-and-a-half later, there was much more information, but not much more light. The writer organized an international conference at the New York Academy of Sciences in 1961 (*Annals of the NYAS*, Vol. 95, ed. R.W. Fairbridge). At least half the audience was not impressed by the evidence. But one of them was an amateur astronomer, a former Singer sewing-machine salesman, Clyde Stacey, who lived in retirement in Puerto Rico. He worked longhand, without the aid of a computer, and not even a pocket calculator, using the mechanical analogy of gear systems to describe planetary cycles. Stacey had no academic qualifications, and found his writings rejected by both *Nature* and *Science*. He approached us after the seminar, and was invited uptown to Columbia University. For hours, he spelled out his concepts. It was then arranged for the New York Academy of Sciences to publish them (*Annals of the NYAS*, Vol. 105, No. 7, 1963), and a few years later, excerpts were included in *The Encyclopedia of Atmospheric Sciences and Astrogeology* (ed. Fairbridge, 1967).

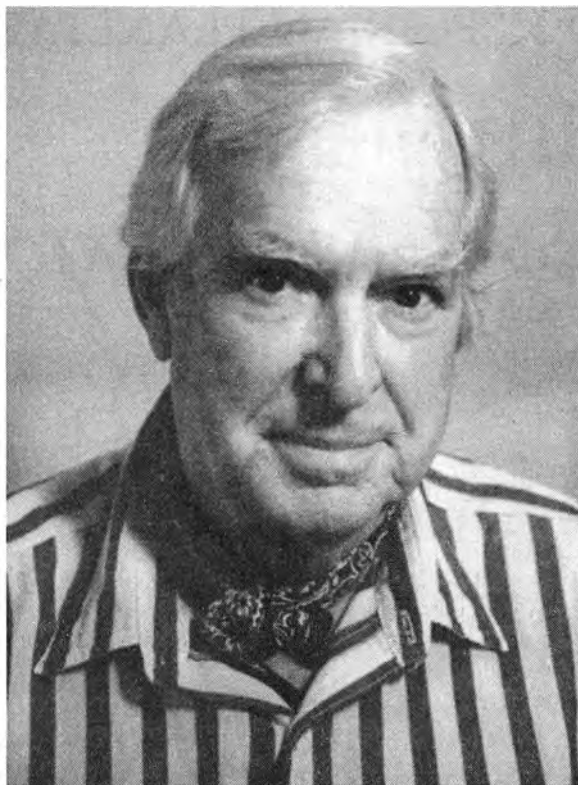

Author Rhodes W. Fairbridge on his 80th birthday, May 21, 1994.

Stacey pointed out to us that a planet revolving about the Sun in its "Keplerian" elliptical orbit delivered no energetic jolt to the Sun's photosphere, such as might explain the episodic growth of sunspots. But when two planets are involved, as the faster one passes the slower one, there is briefly a combined gravitational effect that is felt by each of the planets, and more importantly, by the Sun itself. This is not a tide (which is minuscule), but a torque. The outer, gaseous layers of that star have a low viscosity that is susceptible to any change in the angular momentum, just like the Earth's atmosphere (in contrast to its hydrosphere and lithosphere).

One should bear in mind that there are two sorts of angular momentum involved: one relating to the spin of a rotating body, the other to its orbital motion. According to Theodor Landscheidt, one of the contributors to Rampino's *Climate* volume (1987, noted above), the

"fun" starts when the Sun's axis of spin is overlapped by the axis of revolution of the planets. To put it another way, the barycenter (center of mass) of the Sun does not normally correspond to the barycenter of the total solar system. The barycenter of the Solar System as a whole varies, as the planets revolve, and their masses accumulate on one side, or the other (Figure 1). The barycenter for the system as a whole can be greater than one solar diameter outside the Sun, or can find itself at the center of the Sun. One thus has two relevant axes to consider: the barycenter, which is the axis of revolution of the planetary system as a whole, and the Sun's own spin axis.

Interestingly enough, Landscheidt, like Stacey, was not trained either in physics or astronomy; he was, in fact, a High Court judge in Germany, before he retired to the peace and calm of Cape Breton Island in Maritime Canada. Landscheidt demonstrated that when those two axes, and their associated *momenta*, overlap (when the barycenter of the Solar System and the center of the Sun correspond), they merge, but at the transition, in and out, there is evidently a severe jolt to the system. That is the jolt that Stacey was looking for. In a recent *Encyclopedia of Planetary Sciences* (ed. Shirley and Fairbridge, 1997), it is referred to as the *solar jerk*.

Jupiter and the Sunspots

The phenomenon created by the passage of a faster moving celestial body past a slower one, is a new periodicity known as a *beat frequency* (BF). Its value can be easily calculated by

use of a formula devised in the late 19th Century by a Berlin professor who was studying acoustics, Hermann von Helmholtz. This Helmholtz formula goes like this:

$$BF = (P_o \times P_i)/(P_o - P_i)$$

where P_o is the orbital period of the outer (slower) body, and P_i is that of the inner (and faster) one. As with any wave-like form, the wavelength is the inverse of the frequency.

If we take the periods of the two largest planets, Jupiter and Saturn, the beat frequency = 19.8593 (± 0.6) years. For Uranus and Saturn, it is 45.392 (± 4.0) years. For Earth and Venus, it is only 1.5987 years. But this is an approximation, because the elliptical orbits of all the planets vary, although within fairly predictable limits. These values were first calculated

in detail by a French mathematician, Pierre Simon Laplace (1749-1827), who was the son of a small farmer, and happily survived the head-chopping entertainments of the Revolution. Later, he became honored as an aristocrat, Le Marquis de Laplace, in 1835, who provided us with an *Exposition de Systême de Monde*, which eventually appeared in Vol. 6 of the sixth edition of his collected works, published in Paris in 1884. He was able to prove the ultimate stability of the Solar System, no less.

One of Laplace's many useful observations, from our viewpoint, was the simple integer ratios that exist between the various orbital periodicities, 2:3, 5:9, and so on. These ratios apply not only to orbits, but to phenomena dependent upon them. Thus, the period of Jupiter (11.8626 years) and that of the mean Sunspot Cycle (11.1212 years) is precisely in the ratio of 15:16.

King-Hele and the Orbital Symmetry Progression

This essay began with a mention of King-Hele's work. King-Hele was able to identify a cyclical process referring to the return alignments of Jupiter, the center of the Sun, and the center of gravity of the Solar System (the barycenter). This *King-Hele Cycle* is 177.9394 years. And now, we find that 1/15 of this cycle gives the period of Jupiter, and 1/16 gives the mean Sunspot Cycle.

Sunspots have been observed telescopically since the time of Galileo (1610). By use of proxies, and by documentary evidence, an English antiquarian and schoolmaster, Derek Justin Schove, was able to trace the record back more than 2,300

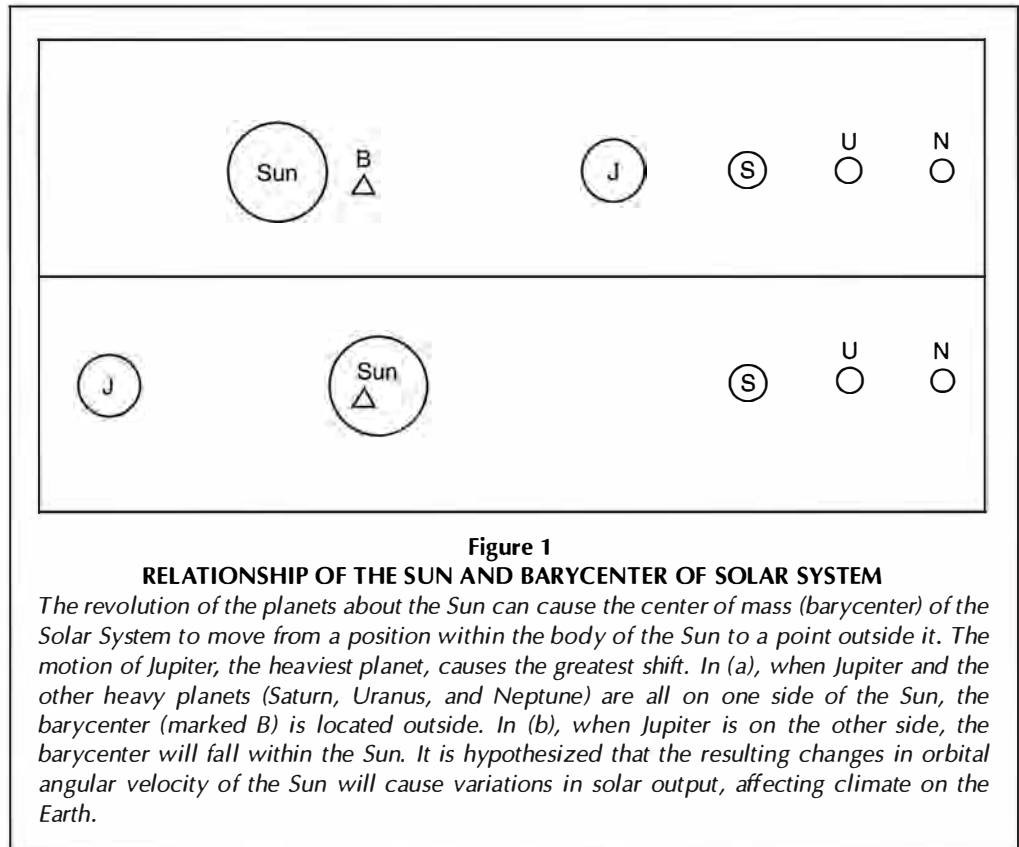

Figure 1
RELATIONSHIP OF THE SUN AND BARYCENTER OF SOLAR SYSTEM

The revolution of the planets about the Sun can cause the center of mass (barycenter) of the Solar System to move from a position within the body of the Sun to a point outside it. The motion of Jupiter, the heaviest planet, causes the greatest shift. In (a), when Jupiter and the other heavy planets (Saturn, Uranus, and Neptune) are all on one side of the Sun, the barycenter (marked B) is located outside. In (b), when Jupiter is on the other side, the barycenter will fall within the Sun. It is hypothesized that the resulting changes in orbital angular velocity of the Sun will cause variations in solar output, affecting climate on the Earth.

years. Schove's collected papers were published in 1983, and he was one of the invitees to the New York Academy of Sciences meeting in 1961. As mentioned before, not everyone there was overwhelmingly in favor of his results. Nevertheless, they can now be checked against the Jet Propulsion Labs' ephemeris, and they match.

Following a suggestion by this writer, a Swedish engineer, Hans Jelbring carried out a power-spectrum analysis of the entire Schove sunspot (proxy) record, which was precisely confirmed and published in my 80th birthday volume, edited by Charles Finkl (*Journal of Coastal Research*, Special Issue, Vol. 17, 1995). In addition to the mean periodicity, Jelbring also showed that there were long-term cycles that were superimposed.

Also included in that 80th birthday volume (1995), was a major synthesis prepared by two other Swedish investigators, Göran Windelius and Nils Carlborg (the former, alas, deceased; the latter at the Stockholm Observatory). The angular momentum question was closely examined, and illustrated in charming cartoons by an English artist, Peter Tucker. A feature of the Saturn-Jupiter alignments (we call them "laps," as in racing parlance, thus SJL for short), is their return to the same celestial position, roughly every 178.7337 years ($9 \times$ SJL). It matches the orbital symmetry (Fairbridge and Sanders, 1987), so we call it the *OSP*, or orbital symmetry progression (see Figure 2).

The orbital symmetry progression and King-Hele cycle values (178.7337 and 177.9394 years) have a common denominator at 40,036.36 years, when their ratio is 225:224. A num-

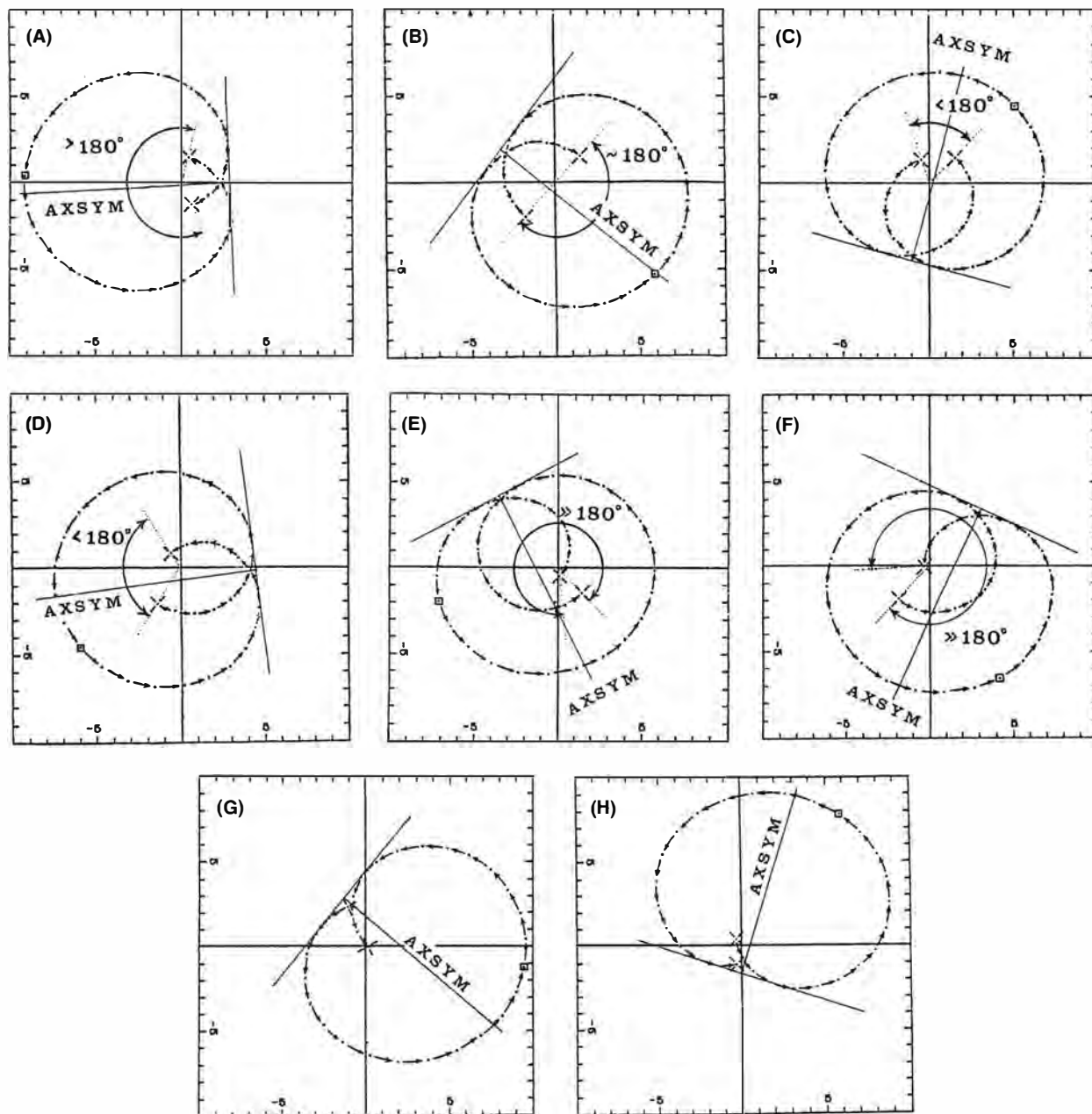

Figure 2
ORBITAL SYMMETRY PROGRESSION

In the 1980s, Fairbridge and Sanders worked with a NASA/Jet Propulsion Laboratory-generated ephemeris of the orbit of the Sun around the solar system barycenter. They identified eight characteristic orbital patterns for the Sun, principally determined by the position of the most massive planet, Jupiter, with respect to the second most massive planet, Saturn, and modulated by the relative positions of all the other planets. The Saturn-Jupiter "Lap" of approximately 19.8 years is then seen to be a key factor in solar-driven climatic patterns.

For convenience, they drew a tangent line to the heart-shaped solar orbit, and an axis of symmetry (AXSYM) perpendicular to it. The thin dotted lines are drawn through the positions of the Sun nearest to the barycenter (peribac). The eight orbital patterns (A-H) are characterized by the amount of angular rotation of the axis of symmetry with respect to the peribac positions. The patterns A-H shown here, correspond to the years (A.D.):

A = 1416-1533; B = 1733-1751; C = 1712-1733; D = 1573-1593;
E = 1671-1694; F = 1929-1951; G = 1616-1632; H = 800-816.

ber of other planetary periodicities conform to this value, such as the Jupiter-Venus Lap at 1.5987 years ($\times 1371$). To achieve a complete planetary line-up, one has to go to 1,101,000 years ($6160 \times$ orbital symmetry progression). What is quite remarkable about this value is that it is a precise round number in terrestrial (anomalistic) years. This is true also for the various beat frequency values, thus, the Saturn-Jupiter laps of 19.8593 years is exactly 55,440.0 in 1.101 million years.

The Challenge for the Present Century

When it comes to the Earth's climate, it should be recognized that far greater fluctuations than the "global warming" attributed to human activity, are measured in the recent geological past. Volcanic eruptions, like those of 1883, 1815, and 535 A.D., or going back many millennia to Mazama (about 8,000 years ago), or Toba (74,000 years ago), all created cooling episodes. However, if we restrict the discussion only to the warmer cycles, we find that, in fact, these are just as large as the cool cycles, but simply in positive sense. It seems they must derive from solar relations. The Sun's emissions definitely fluctuate. For the last 10,000 years or so, we are provided with several "time-series" that quantify such events, or intervals (some lasting several centuries).

Climatic "time-series" spanning multiple millennia are few in number, but persuasive, because most of the "little wiggles" seem to go in the same direction. The essential criterion for a time-series is that a time-measure is established corresponding to annual units, as in tree rings, ice cores, or varve (geological deposit) sediment layers. These can then be matched against astronomically determined motions and periodicities among the planets, that include also our own Earth and its Moon. Next, the time-series can be subjected to various forms of Fourier analysis to establish a power spectrum of periodicities. During the last decade, this procedure has yielded gratifying results. For example, a recent issue of the journal *The Holocene* (Vol. 12, pt. 6, 2002) contained numerous examples based on tree rings.

The ultimate source of climate is, of course, the Sun. Climatic fluctuation may be derived from: (a)

solar emissions, that is, radiations in various electromagnetic wavelengths, ultraviolet, optical, infrared; and particle transmission, such as in the solar wind. From (b) orbital factors, affecting Earth's distance from the Sun, which is constantly changing with the phases of the Moon, as well as the geometric arrangements of the planets. And finally, from (c) terrestrial factors, which include latitude, topography, air-sea exchanges, ocean currents, atmospheric circulation and chemistry. Sun-Earth relations are sometimes compared with the game of baseball. you have the pitcher (the Sun), the hitter (the Earth,) and not least, the crowd (all the environmental factors).

The beauty of time measurement with substantive material, like ice, or mud, or wood, is that these things, in addition to mathematical analysis, can also be subjected to various forms of geochemical analysis. Isotopes of oxygen provide measures of temperature, and the flux-rate of carbon-14 (in tree ring wood) supplies an inverse signal of solar emissions. Both of these records go back more than 10,000 years, and can be compared directly with the astrochronology. This is the ultimate breakthrough for the 21st Century, providing the potential for predicting not only the sunspot behavior, but also the El Niño expectancy and various storminess systems.

Storms on planet Earth are predominantly in two categories:



Rhodes Fairbridge

The Hudson Bay "staircase," a typical series of 184 successively uplifted strandlines, situated in Richmond Gulf on the eastern side of Hudson Bay, Canada. The sand-gravel beaches are preserved by permafrost, and recur with great regularity about every 45 years, representing the cycle of storminess. There are also longer cycles of 111 and 317 years evident in the beaches, which are linked with planetary cycles.

those originating near the Equator, and those originating in subpolar latitudes. The first of these introduces the role of the Moon, which has an important declination cycle (18.6134 years; see *Tidal Dynamics*, a new two-volume work by Wood, 2002). Declination during its hemicycle shifts the Moon's zenith position nearly 1,200 km north-south over each hemisphere, which has the effect of accelerating the geostrophic currents like the Gulf Stream and Kuro Shio. A stronger Gulf Stream warms the Murmansk Current north of Russia, and pushes back the polar sea ice creating an extended season of open water, which increases the snowfall over Siberia and central Asia.

Historical (proxy) evidence of Arctic temperatures suggest an approximately equal role for the Moon's declination cycle and the Sunspot cycle (11.12 years), in the ratio of 3:5. But in high latitudes, the double Sunspot Cycle or Solar Magnetic Reversal (at 22.24 years), is more important, so the ratio would be 6:10, creating a well-known 111 year periodicity. An interesting link with planetary cycles exists at a triple ratio figure: 317.749 years (7 Uranus-Saturn laps/ 16 Saturn-Jupiter laps/ 17 lunar declination cycles). A storminess record in geomorphic (that is, physical) form is preserved in a "staircase" of 184 isostatically uplifted beach lines on Hudson Bay (Fairbridge and Hillaire-Marcel: 1977 *Nature*, Vol. 268), which date back more than 8,000 years. Their extraordinary regularity is duplicated in other parts of the Arctic, which denies any theory of randomness in storminess cycles. Their mean periodicity is about 45 years, but sec-

ondary modulation appears at 111 years, 317 years, and longer intervals.

The Tidal Drag Effect in El Niño

In tropical regions, the most prominent storminess system relates to the Asiatic Monsoon. For more than a century, it has been known that extra snowfalls in the Himalayas were often the precursors of droughts and famines in India. The 18.6-year lunar cycle was long recognized, but there is another factor that is now linked to the El Niño phenomena, shifting from the western Pacific to the Indian Ocean.

There is a dynamic link between the Pacific and Indian oceans through tidal action. As the globe spins eastward, the tidal bulge moves westward. However, in the tropical belt this diurnal rise of sea level is partially blocked by a series of physical constrictions, and a shallowing of the sea floor in the two largest continental shelves of the world (Sunda and Sahul shelves) that are symmetrically located north and south of the equator. From the Sunda Strait in the west to the Torres Strait in the east, the ocean current is almost always towards the Indian Ocean, accelerated with the rising tide, and amplified during the lunar cycles.

The water with each rising tide brings a cool pulse to the lower atmosphere, a sequence of such cool input corresponding to the tide cycles. These are modulated on a variety of time spans: fortnightly; seasonally (with the monsoons); annually; with the perigee-syzygy periods (4 and 8 years); and with the declination (18.6 years). An approximate resonance of 16:15 occurs between the 18.6-year lunar period and the Saturn-Jupiter beat. Even further, there are amplifying lunar cycles at 31, 62, 93, 111, 186, and 558 years.

With increasing complexity, these periods and their harmonics interact with those of the solar emissions. The most prominent effects are the El Niño and related ENSO (El Niño Southern Oscillation), probably forced by atmospheric feedback from the Indonesian-New Guinea "choke" region. ENSO occurs irregularly, at 2 to 9 year intervals, and discloses both lunar and solar potential forcings. The forcings are mostly fractions of the planetary quadrature series of 4,448 year. These appear at 164th of the quadrature, 69.50575 years, and three times that at 208.522-year forcings which are prominent in the carbon-14 flux of tree rings.

To conclude, I would like to emphasize that the entire field of planetary-lunar-solar dynamics needs to be studied in relation to terrestrial climates. The assumption made by some scientists that the field of climate is isolated in a fog, limited by only a few centuries of data is self-defeating. With thousands of years of material waiting to be analyzed, some wonderful challenges call for the attention of the 21st Century.

Dr. Rhodes Fairbridge is Emeritus Professor of Geology at Columbia University in New York. Born in Western Australia in 1914, he studied geology in England and Canada, ending up at Oxford University. He served during World War II as an intelligence officer in the southwest Pacific, under General Douglas MacArthur. He finds it of current interest that his first overseas job was with the Iraq Petroleum Company.

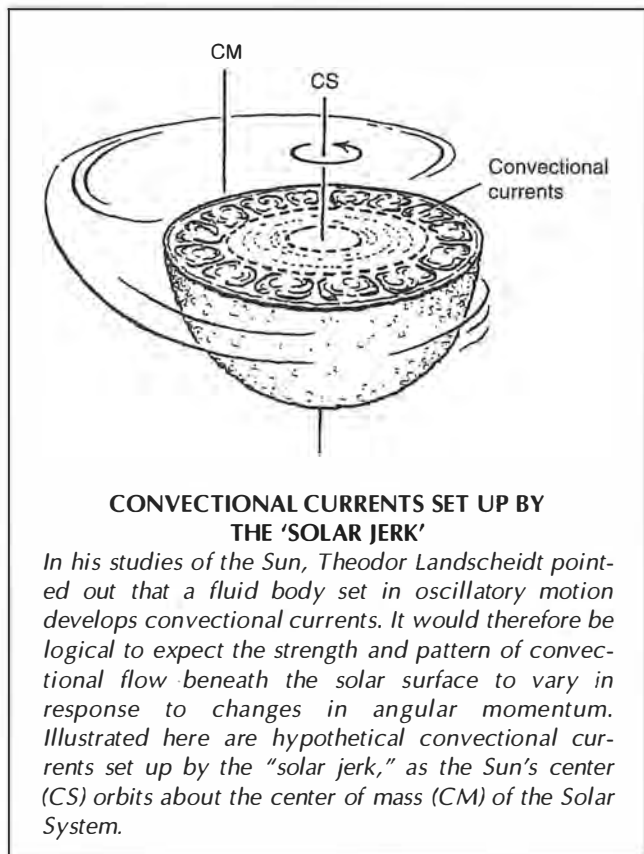

EXPEDITION ARES

A Saga from the Dawn of Interplanetary Travel

INTRODUCTION

Krafft Ehricke's Manned Mission to Mars

When he began writing *Expedition Ares* in 1948, German-born space scientist Krafft Ehricke (1917-1984) had been in the United States for one year, and was living on the U.S. Army base at Ft. Bliss, Texas. He was one of the German space pioneers helping to transfer to the U.S. Army the rocket technology which the Germans had developed before and during the World War II, and had brought with them to the United States. Dr. Ehricke was writing up, from memory, the technical details of the V-2, or A-4 rocket, and helping to translate the reports of other members of the group into English.

Most of the men were learning English, many by sharing the one available dictionary, and watching cowboy movies. Krafft Ehricke applied his engineering knowledge and engaged his imagination to look toward the future; he created a story, written in English, describing the first manned missions to Mars.

At that time, the only large liquid-fueled rockets ever launched were the wartime V-2s, which just barely reached space. But Ehricke could see a time, even if far off in the future, when the finicky technology of chemically propelled rockets would be mastered, the political will would be marshalled, and the resources committed, so that man would

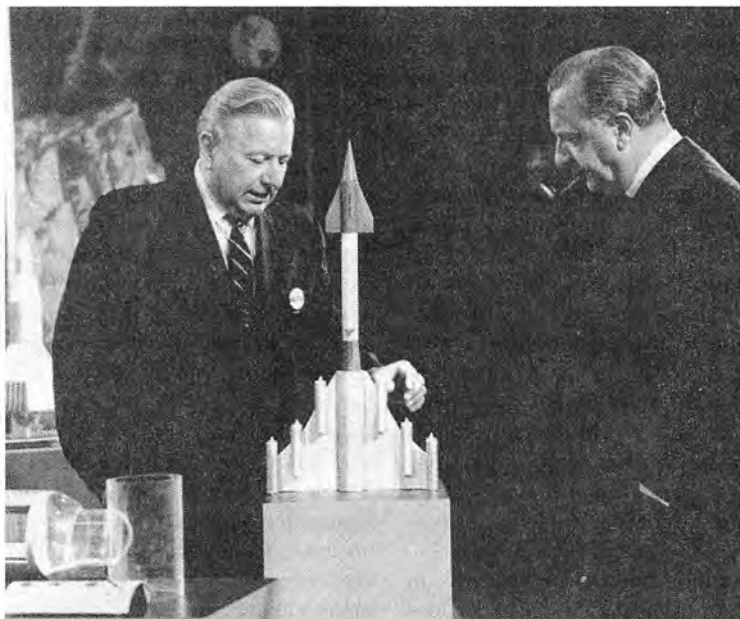

Courtesy of Krafft Ehricke

Space visionary Krafft Ehricke (left) was interviewed by CBS correspondent Walter Cronkite on Sept. 26, 1966. Ehricke, who worked for North American Rockwell at the time, is discussing the features of a reusable transport vehicle that he designed. The initial stage of the vehicle consists of 12 turbo-ramjet engines. A supersonic ramjet engine allows the vehicle to achieve orbital velocity; the hypersonic spaceplane atop the transport would return to a landing site for reuse.

embrace the possibility of leaving the Earth, to head for the stars.

Ehricke chose a writing style brilliantly employed by a 19th Century predecessor—Jules Verne—who had fired the imagination of youth all over Europe, through his series of engaging books about an imaginary trip to the Moon. Using the development of a delightful array of characters, Verne had summarized for his readers the scientific knowledge of his time about space travel, and Luna.

Expedition Ares

Ehricke's setting is more than 400 years in the future, when space travel throughout the Solar System is commonplace,

and mankind hardly remembers the first “baby steps” taken to explore the planets. He tells the story of Expedition Ares, which takes place around 2050, as “ancient” history, looking back 350 years from 2400.

Ehricke describes in exacting detail the family of different spacecraft, sent abroad as a fleet, that will take the first eight travellers to Mars. Each vehicle is optimized for its particular function, whether that is to travel from the Earth to orbit, travel from the Earth-orbiting space station through interplanetary space, or land on Mars. Ehricke’s Earth-to-orbit space ship has dimensions comparable to the 1969s Saturn V rocket that took men to the Moon. His glider rockets are similar to a family of Orbital Space Plane designs which NASA is considering today, for servicing the International Space Station.

Discussing the question of what kind of propulsion system should be used for the Mars journey, Ehricke acknowledges that nuclear fission would be far superior to chemical propulsion, by shortening the risky trip. But, he reports through his fictional characters, the development of fission propulsion would delay the mission for 50 years!

In order to decrease the risk of an adventure that will have the crew travelling in space for 516 days, and staying at Mars for an additional 455 days using chemical propulsion, Ehricke provides them with eight “lifeboats,” one for each crew member. These “L-rockets,” he says, are “completely new devices and are vital for general safety. They offer the crew a last life-saving chance in case of an accident.” This level of multiple capabilities and redundancy, which in this story saves the lives of the crew, reflect a philosophy hardly followed today, but which should be a prerequisite for the future.

After leaving the space station, the Ares crew, sets off for months of travel to Mars. Along the way, they observe fascinating new phenomena of interplanetary space never seen before by men, and they have a close encounter with a previously unknown asteroid. During their long journey, the crew must perform intricate maintenance and repair of the spacecraft, which, decades later, cosmonauts aboard the Russian Mir space station would replicate, in order to keep their station operational.

But, alas, Expedition Ares is not destined to be a success. In a series of events which eerily foreshadow the crisis decades later aboard Apollo 13, the crew suffers a near-catastrophic accident, and must head back to Earth. Like the Apollo 13 astronauts, who survived only because of the availability of the Lunar Excursion Module, or lander, the crew of the Ares Expedition makes use all of their vehicles to return to Earth orbit and Space Station I.

It is remarkable that Krafft Ehricke could imagine that the entire world would be riveted to this unfolding drama in space, and be mobilized to offer whatever help was needed, just as was the case with Apollo 13. After close calls, and even the rescue of a crew member who takes refuge on the Moon, Ehricke ends his tale stating that this first manned mission to Mars, although it failed, was “not the end, but the beginning of a great story.”

A Life in Space

Krafft Ehricke became intrigued with space flight in 1929, when, at the age of 12, he saw the Fritz Lang film, *Woman in the Moon* in a Berlin theater. Two years later, he became aware of the activities of the spunky German Society for Space Travel, but he was too young to join. He continued his studies, however, and in 1934, at the age of 17, he wrote *Thoughts of Space and Man*, a collection of short stories about scientific discovery, also yet to be published.

In 1938, Ehricke helped organize the amateur Society for Space Research, and wrote articles for its journal *Space*, even through the war. He was attending the Technical University Berlin when World War II interrupted his studies, and he was drafted into the German Army.

But in 1942, two patents he had previously filed on rocket technology brought him to the attention of army technical personnel, and he was transferred to the rocket research program at Peenemünde. He later learned that his entire tank unit had been wiped out at the Russian front.

At Peenemünde, Krafft Ehricke was assigned as an assistant to Dr. Walter Thiel, Director of Propulsion Development. He was able to gain hands-on experience with the hardware of this new technology of rocketry, as well as to investigate questions, such as the use of nuclear fission energy for rocket propulsion. When he arrived in America, Krafft Ehricke had the practical experience, the theoretical background, and the dreams, that were all necessary for space travel.

Throughout his career, Ehricke tackled questions and challenges concerning every aspect of space exploration and development, from trajectories of unmanned probes to the planets, to using the microgravity of space for therapeutic treatments, to tourism. From the mid-1970s to the mid-1980s, in the last decade of his life, he devoted his energies to describing, in elegant detail, how to industrialize the Moon, and make it the “seventh continent” of man’s Earth.

To Krafft Ehricke, space exploration was not an extracurricular activity, but a function of an “extraterrestrial imperative.” For man to progress, he has no choice but to expand his world view and his realm of activity to the entire Universe. There are no limits to growth, Ehricke insisted, when that false notion became popular in the late 1960s, because there is no limit to man’s creativity.

Were man to deny that imperative, and try to live only within the fixed limits of his original home planet, Ehricke stated, the result would be geopolitical power politics, stagnation, and eventually ecological crises, mass starvation, wars over limited raw materials, epidemics, and revolutions—a New Dark Age. Indeed, having ignored the warnings, we stand at that precipice today.

Krafft Ehricke believed that a new Renaissance was necessary. Works, such as his *Expedition Ares*, embody the optimism, the commitment to scientific and technological advancement, and the belief in the irrepressibility of the human spirit, that mankind must marshal today to make this, and other great projects, a reality.

—Marsha Freeman

EXPEDITION ARES

A Saga from the Dawn of Interplanetary Travel

by Krafft A. Ehricke

An imaginary account of space travel in the year 2050, written in 1948 by preeminent space visionary Krafft Ehricke (1917-1984). These are excerpts from his unpublished manuscript.

We live in the age of fast-flying, far-reaching space ships, and are proud of what human ingenuity has achieved in this field. Research is going on with ultra-fast ships, reaching half the velocity of light and designed as powerful instruments for visiting our neighboring stars.

But the adult soon forgets the first stumbling steps of childhood, and the first attempts to reach our nearest cosmic vicinity has almost completely vanished from our memory.

Looking back through the centuries, we perceive a chain of heroic deeds which mark man's grasp at other planets. Only 50 years ago, Glenn Wolf's party landed on Pluto. Their flash light photographs showing the men wading through helium pools amidst fantastic structures of frozen gas which tower into the eternal night, belong to the standard equipment of astronomical books today.

A hundred years ago, Ted Aitken, the most fearless space explorer of his time, died in a bold attempt to reach Saturn. His ship, the famous "Nightmare," was smashed between the rocks of Saturn's ring after a meteor had blown away the navigation room.

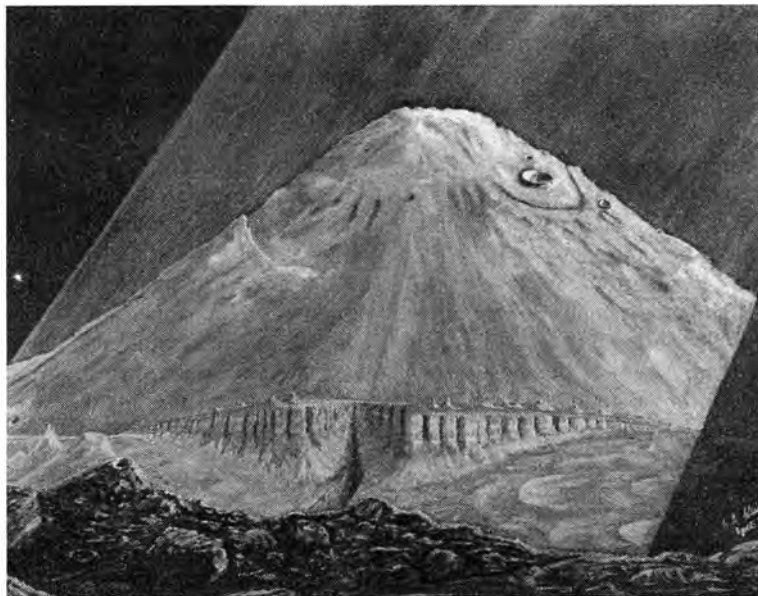

Krafft A. Ehricke

In 1979, Krafft Ehricke imagined Mars to be a planet with an active geologic past, unlike the Moon. He created this painting to represent that concept. Near the top of the mountain—perhaps a volcanic caldera—are gullies, very similar to those found recently on the sides of craters on Mars. They could have been produced by flowing water, or in this case, maybe seeping lava. To the lower left is the faint Sun.

A hundred years before his time, Gordon Rockwell opened the golden age of discoveries. He was the first to jump in his ion-powered "Blizzard" over the great gulf—the vast gap behind Mars, as they called it—and intrude into the dangerous realm of Jupiter's satellites. This pioneer discovered fossils of a strange life on satellite 111. It blossomed millions of years ago when the giant planet was still the hot, animating center of its extensive system. Rockwell actually founded the cosmic branch of palaeobiological sciences and made Jupiter's moons an El Dorado of cosmic life research.

Even farther back, old

documents reveal the tragedies connected with the exploration of Venus and tell a tale of Duke Hatchword's "sunny" trip to Mercury . . . yes, planet after planet unveiled their secrets before the eager spirit and ironclad will of keen explorers.

Yet, there is one planet which must be mentioned separately. Mars, the most familiar outer world for our generation, is connected with the very first beginnings of space travel.

Back in the 20th Century, when tiny rockets climbed a meager 200 miles (did you ever hear of a "V-2" or a "Neptune 8"?), Mars was the dream goal of those who believed in space travel, actually a fantastic conception when one considers the troubled and primitive world into which they were born. Mars was considered the most interesting planet in the system, the only one that might bear life. Some even dreamed of a Martian civilization, superior to ours, with which a cosmic exchange of ideas might be brought about. Small wonder that Mars became the first planet ever explored by man.

Circling Earth in small scout rockets, scientists and engineers, dreamers and adventurers, found themselves on the brink of a vast emptiness, beyond which new worlds lured and stimulated their desire to remove the barriers erected between man and star.

The first attempt to realize these dreams is known in history as "Expedition Ares."

II

. . .It was long, long ago in the year 2000. We are in space. A giant globe arches to our right, 500 miles away. Its bulky outline covers a major part of the sky. But only a slim sickle unveils its bright shape to the observing eye. The remainder is absolute blackness. It constitutes a sinister, blind hole in the glorious panorama of stars around, suddenly interrupting the gleaming galactic arch where countless stars are blending to shining clusters, looming at the edge of infinity.

Out of this black hole came our ancestors.

At the end of the 20th Century they finally shattered the chains which kept them in bondage of time and space. Vigorously they had invaded the realm of nature, making themselves masters of energies never dreamed of before. What had been achieved in a relatively short period was really amazing. . . .

Elated with what had been done, the best among them fought for the highest goal: Detachment from their star and flight into the glaring purity of untouched space. The planets, well known to us, were unknown land for the pioneers of these old days.

A few decades later, the first step was completed. One night, human eyes observed the first star in the sky which was man's creation: "Space Station I."

No product of human skill ever earned more acclaim than this first artificial satellite. This tiny moon was hailed as the *non plus ultra*, the masterpiece of man's ingenuity. It was com-

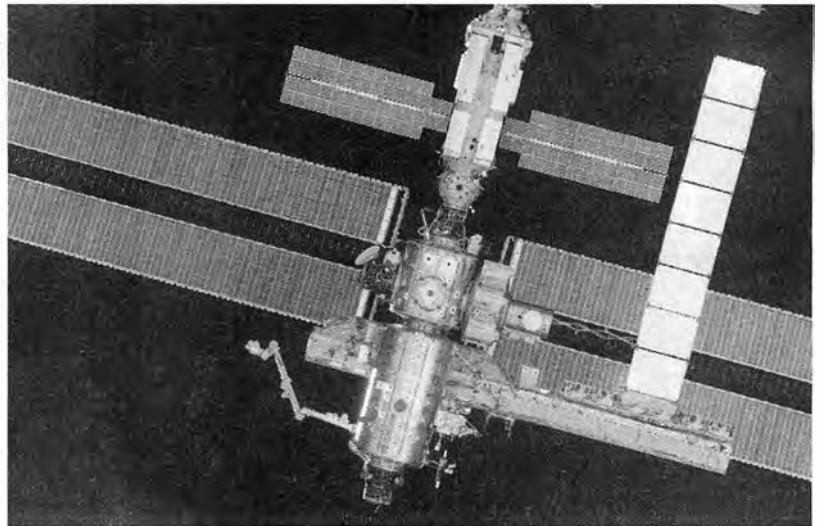

NASA

"One night, human eyes observed the first star in the sky which was man's creation: 'Space Station I.' " Much like the International Space Station, seen here in November 2002, Krafft Ehrlicke's Space Station I had living quarters and scientific laboratories. It also was the location for the assembly and launch of spacecraft headed to the rest of the Solar System.

pared to a gigantic sign board to mark the entrance to Earth from outer worlds. Once established, Space Station I became the springboard for even more daring enterprises.

The artificial satellite was very small. It consisted of a power station, which also housed the living quarters and the radio center. Around this main body were scattered several scientific laboratories and the space observatory. Many problems had to be solved before an actual space flight could be launched.

In the medical laboratory of Space Station I, Dr. van Horn developed space medicine beyond the guesswork of his predecessors, by experimental facts which could not be gained on Earth.

The physical laboratory witnessed the development of space navigation instruments, crude prototypes of today's unerring and reliable homing devices. The 20-inch mirror in the space observatory recorded new facts about the planets. The investigation of solar and stellar spectra in the deep ultraviolet furnished new and important data for the understanding of the internal structure of the stars. Other important research objects were the primaries of cosmic radiation and the analysis of interplanetary matter, especially the mean density of meteors in space. A second tiny moon, measuring 900 feet in diameter, was discovered.

It is hardly believable with what primitive means of navigation the first ships hopped to Moon. But they did it, and gradually, as ships and navigation improved, Moon became a world "just around the corner," like the inner planets are for us now. The vast area between satellite and Moon became a training field for advanced students of the space navigation school attached to the station. Two agencies even obtained licenses for regular tourist flights around Luna, in small but rather comfortably equipped "space liners" as they were then called,

These were the general conditions at that time. They show

“Once established, Space Station I became the springboard for even more daring enterprises.”

how tremendously the existence of a space station increased the possibilities for actual space flight. The familiarity in dealing with such little trips, as we possess it, absolutely did not exist in these days.

To estimate the tremendous amount of work and expenses engaged in the satellite enterprise it must be remembered that the only power source available at that time came from the reaction of chemicals, a million times weaker than the nuclear reactions with which we have worked for a long time. Nuclear science was only in its beginning, and no power unit for space ships had been developed yet. Small wonder that the space ships of the 21st Century were bulky, clumsy, and underpowered.

For instance, the ferry used for space station maintenance was unique by today's standards. It consisted of four rockets mounted one above the other. The height of this colossus was 190 feet, the diameter of its first or lowest stage was 44 feet. It may still be seen in the main hall of the Washington Museum of Space Exploration, technical department. The net payload actually delivered to the space station was only 10 tons, although the whole ship weighed not less than 3,460 tons at the moment of take-off! Ninety percent of the tremendous mass was the chemical propellants. A considerable idealism must have been essential to flying these giant firecrackers!

The start of such a ferry ship was comparable only to the eruption of a volcano. More than 59,000 pounds were bursting from its stern at 6,800 feet per second to yield 6,000 tons of thrust, which drove the tower upward with the slowness of a freight elevator. After 51 seconds of vertical ascent (the giant ship could not be inclined without breaking its back), the first booster burnt out and was jettisoned, as the second stage ignited. This second booster burned for 57 seconds with 2,000 tons of thrust. At the end, it was jettisoned like the first one.

The two remaining rockets had a velocity of 9,600 feet per second, and their axis was inclined by 45 degrees against the direction normal to the surface of the Earth. The third boosted the ship to 17,000 feet per second in 158 seconds at 500 tons thrust. The final stages accelerated to a velocity of 25,000 feet per second at 70 miles altitude, where it entered an elliptic flight path which brought the ship to the circular orbit of the space station. The landing back on Earth was made by using atmospheric drag in a long gliding path, for which the upper stage was

equipped with wings. The most common propellant components used were hydrazine as fuel and nitric acid as oxidizer.

Even this giant ship was not able to land on Moon in a non-stop flight from Earth! The upper stage, however, could be refueled at the space station and used for Moon trips after some adaptations, such as decrease of payload and dismounting of the wings and tail fins, which are unnecessary in space.

This fact underlines strongly how important a space station necessarily must have been for those people with the energy sources available to them. It cannot be overemphasized that in this stage of development, space travel was impossible without a space station.

Summarizing, the situation in the year 2040 was as follows: An artificial satellite had been created. It revolved at an altitude of 550 miles around Earth and served as a research station and propellant depot. Regular flights to Moon were possible because of its existence. The Moon rocket was the final stage of a giant four-step ferry, which provided the satellite with all necessities and enabled slow accumulation of sufficient propellant for more extended trips. Each 10 tons of net payload brought to the space station level a costly 3,200 tons of propellant, not to mention the expense of an elaborate organization on the ground. The artificial satellite was a first-grade economical problem!

III

In 2040, 40 years after the creation of the artificial satellite, a second and most decisive step was taken. The Research Board of the Association for Space Exploration, the



NASA

“The start of such a ferry trip was comparable only to the eruption of a volcano.” The ships that serviced Space Station I were three-stage rockets, similar in design to the Saturn V rocket seen here, which 20 years after the writing of Expedition Ares, took Apollo astronauts to the Moon.

most powerful research organization of its time, stated in a memorandum dated March 20, 2050, that within five years enough surplus propellant of the hydrazine-acid type would have been accumulated in the satellite depot to permit an expedition to one of the nearer planets, either Venus or Mars. This memorandum was submitted to the government with a preliminary breakdown of the necessary preparations and the cost of an interplanetary expedition. A conference was called of leading scientists, engineers, and economists to discuss the problem from all angles, prepare a more detailed plan, and decide which planet should be visited. It was inevitable that Mars would be selected. The final report said:

"In comparing both planets, it must be stated first that merely to pass the planet at a great distance is out of the question. Such a trip would not justify its cost nor could the flight paths to and from the planet be half-ellipses. We are still bound to such orbits, since shorter paths are too expensive in propellant consumption."

"From the astronomical point of view Venus comes nearest to Earth (26 million miles). The cruising times to and from Venus would be 146 days each. The necessary "stay time" in space between capture and re-escape is 470 days, under these conditions. The corresponding values for Mars (48,600,000 miles average distance from Earth at opposition) are 516 days total travel time and 455 days stay time. The overall travel time favors Venus (762 days as against 971 days) and the escape velocity from Earth for a Venus expedition is somewhat less than that for Mars. However, the capture process on Mars requires less energy than on Venus, the absolute values depending upon the distance from the planet in question."

"If a planet is reached, it is quite naturally desired to attempt a landing on its surface by means of winged rocket gliders, carried with the main ships. In this respect, Mars is much more favorable since its atmosphere and the principal conditions on its surface are well known, while for Venus quite the opposite is true."

"Finally, there is some evidence of life on Mars; a life which possibly sustains itself by a photosynthetic process using carbon dioxide, water and light quanta. Conditions for successful biochemical research are likely to be much better on Mars than on Venus.

"After deliberating all facts, this committee recommends Mars as the goal of the first interplanetary expedition."

This historical memorandum settled the matter, and the preparations for "Expedition Ares" began.

IV

Two main groups were formed: a technical group headed by Terence Norton, chief engineer of the ASE, and a scientific group led by Dr. Vincent Brooks, a young successful man of the scientific staff of the Space Board, who ran the physical institute of the ASE. The Norton group, in cooperation with many agencies, developed the ships and all accessories, while the Brooks group organized the scientific preparations. To the Joint Development Board belonged, among others, Dr. Jean Tudor of the Space Observatory, who was responsible for the flight path calculations and the navigation program; Dr. Carter

of the Department of Space Medicine, in charge of medical and biochemical work; and Professor Winter, a leading scientist in the geological and meteorological fields and well known for his research on the development of the Martian surface and atmosphere.

In the leading group, Terence Norton realized from the beginning that "Expedition Ares" represented a crucial experiment for chemical rockets. There was a group, and not a small one, which strongly opposed the whole project. Their arguments carried some weight, from both the economic and technical viewpoints. Millions of labor hours had to be expended on a project which promised no immediate return.

Furthermore, the use of chemical propellants was hazardous and there was considerable danger that none of the ships would ever return to Earth. These antagonists proposed that the program be concentrated on the development of a fuel or energy source far more powerful than chemical compounds. This, it was argued, would result in more dependable ships and correspondingly increased safety for the travelers. As conceived, they said, the project was premature and the future of interplanetary flight was imperiled.

Norton fully realized the gravity of those arguments. To wait for the more powerful sources would mean, he declared, a delay of at least 50 years. He determined to introduce in his ships a much higher safety factor than ever was assumed before. He permitted no calculations on the assumption that everything would run according to schedule. In one of his early reports to the Space Board, he said:

. . . In considering the problem from any viewpoint, the question may arise: In what way may the challenge offered by a departure from the normal schedule be met with the technical resources at hand? Does such not improbable situation offer some chances to bring home the amazing results of human courage; or does a failure to cope with the situation mean certain death somewhere in the depths of space, to all on board?

A study of the following pages will show that the technical group has increased the safety factor to a figure far higher than that which was considered the maximum when the project was established. The rest must be left to the character and spirit of the party. It is frankly admitted that possible dangers exist which cannot be anticipated, but the group is firmly convinced that courage, resource, and the scientific attainments of those selected to make the voyage, will meet successfully the challenge of space travel.

There follows an exhaustive description of the project from which only the most important details may be quoted:

Eight persons will participate in the flight, to keep the overall expenditures within reasonable limits. This restriction on personnel permits ample power reserve and research equipment, thereby using only three main ships, each equipped with a system of small, independent power plants, ranging from 11,000 to 572,000

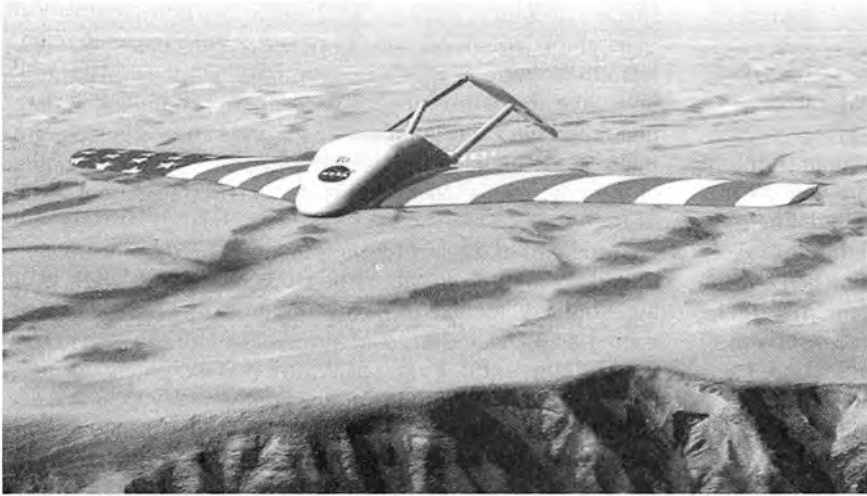

NASA Langley Research Center

"The gliders are powerful enough to fly to the surface of Mars and return to the orbit in which the main ships are circling." Ehrlicke envisioned a family of spacecraft for the manned Mars journey, to provide redundant capabilities to increase safety. NASA has been developing designs for a Mars airplane, which would fly in Mars's thin atmosphere, but not be powered to return to orbit.

pound thrust. Any power plant can be jettisoned without affecting the others. All ships are built according to the "building-set" principles, which allow application of the stage principle to the fullest extent and assure that no unnecessary parts are carried through any propulsion period at the expense of propellant consumption.

The main ships consist of a frame in which the spherical [fuel] tanks, supply containers, auxiliary machines, auxiliary ships, and the gondola for the crew are mounted. Because they are built for space flight only, they need no protective skin or streamlined, outer shape. This reduces the weight, gives very good accessibility to all parts, and simplifies considerably the technical work required between the propulsion periods.

He describes the principal load distribution of the three main ships as follows:

(1) The flagship carries the crew, the most important scientific equipment, food for 260 days, and practically all the oxygen supply. It is the only ship which will return to Earth.

(2) The second ship, a [cargo] carrier, transports the bulk of the food supply, two landing gliders, and the astronomical equipment. The gliders will be detached and the food supply transferred to the third ship before arrival in the final circular orbit around Mars. The carrier will swing into the equatorial plane of Mars and land on Phobos, the inner moon. There, an astronomical observatory will be established for a detailed investigation of the surface of the planet during the stay time of the ships. The large difficulties connected with a free-floating space observatory are thus avoided.

(3) The third ship and the two gliders (under their own power after the detachment) follow the flagship into a circular orbit in the ecliptic plane which requires less propellant consumption since this is the plane in which the ships fly all the way from Earth.

The third ship is a tanker and carries all propellant required for the different propulsion periods during the trip. The other ships are refueled from it after each propulsion period. For this purpose, the corresponding tank spheres will be detached from the carrier and brought close to the ship to be refueled. The propellant will be transferred by a movable feeding system. The weightlessness of all matter in space facilitates the work considerably and makes it possible for a few men to do the job. The empty tanks and other excess parts will be

pushed into space by means of small powder [solid fuel] units. The tanker will be abandoned after departure from Mars when it has delivered its last propellant to the flagship.

The auxiliary ships are two winged rocket-propelled gliders for surface research, and eight lifeboat rockets (L-rockets), one for each participant.

The gliders are powerful enough to fly to the surface of Mars and return to the orbit in which the main ships are circling. Propellant is provided for two flights for each glider to different spots on the Martian surface. The gliders use the same propellant as the main ships.

The L-rockets are completely new devices and are vital for general safety. They offer the crew a last life-saving chance in case of an accident. The term 'accident' means in this connection the possibility that something may prevent the main ships from gaining the velocity necessary for capture within the gravitational field of a planet. Under these conditions, without L-rockets, the ships would pass the planet in a hyperbolic path, and consequently would be lost with all on board.

There are actually only a very few crucial moments which decide the success or failure of an interplanetary trip. These moments are the propulsion periods when near the planet, and it is here that the L-rockets may prove their value. If the main ships are disabled, the crew can take to the L-rockets and gain the necessary velocity accelerations or decelerations.

The L-rockets represent the highest development of the stage principle, and are in themselves the most important safety device that is carried. They will operate in the vicinity of the planet, but outside its atmosphere, and then either remain in an orbit around the

planet or glide to the surface. Their wings will support them in unpowered gliding flight. Their design and power depends consequently on the largest planet contacted, so for "Expedition Ares" they are laid out for Earth.

Their mass is a tiny fraction of that of a main ship, but their mass ratio and exhaust velocity are very great, since their fuel is a special halogen compound. Their ideal performance is 3.3 miles per second, but this speed can be increased by reserve tanks attached to the wing and body which will yield a maximum performance of 5.5 miles per second with three reserve tanks. Because a velocity of 2.23 miles per second is needed for re-capture by Earth at satellite distance, if the ships approach along the scheduled ellipse, the L-rockets have ample power to cope with the majority of emergencies.

The program outlined in Norton's report was followed. Shipload after shipload of parts were transported to Space Station I where they were checked and assembled. New control and navigation devices were tested in flights to Moon.

Two years before the day of departure, the crew was selected.

...For two years the team trained together. There was space ship piloting, space navigation, knowledge of the ships in all details, including maintenance and repair, interplanetary communication, glider and L-rocket piloting, and space medicine. The climax of the training was a Mars trip simulation, elaborated by Norton and Dr. Tudor. They prepared

spacecraft which were in most detail a true model of the Mars ships, equipped with L-rockets. With these ships the team made several trips to Moon, training for all manipulations like the jettisoning of excess parts, refueling during flight, and the capture process with one carrier swinging out into a plane inclined by 23 degrees against the orbital plane of the other ships. Many improvements resulted from these trips.

At the end of the last training flight, the models were sacrificed. Coming from Moon the ships ran against Earth with hyperbolic velocity. The crew entered the L-rockets and each man navigated his ship alone back into the [space station] satellite orbit. Professor Winter was extremely excited. He missed the satellite orbit and finally revolved in a slender ellipse, the perigee being in 20,000 miles distance from Earth. Upon his hectic emergency calls with a tiny radio set that was standard equipment of each L-rocket, an upper ferry boat stage rescued him. His adventure inspired many newspaper cartoons which showed the professor as a new satellite of Earth. But his misfortune had brought about an idea.

"It is very possible," said Norton. "that after exhaustion of the propellant our L-rockets might run in some mad orbits around Earth. We need a radar detection on the satellite and a special Coast Guard service with rescue ships until the expedition is home again."

This new idea was immediately included in the preparations.

Finally, the gigantic work was completed. On a silent, transparent September night, the party started for the ceremony of christening the Mars cruisers which floated quietly beside the

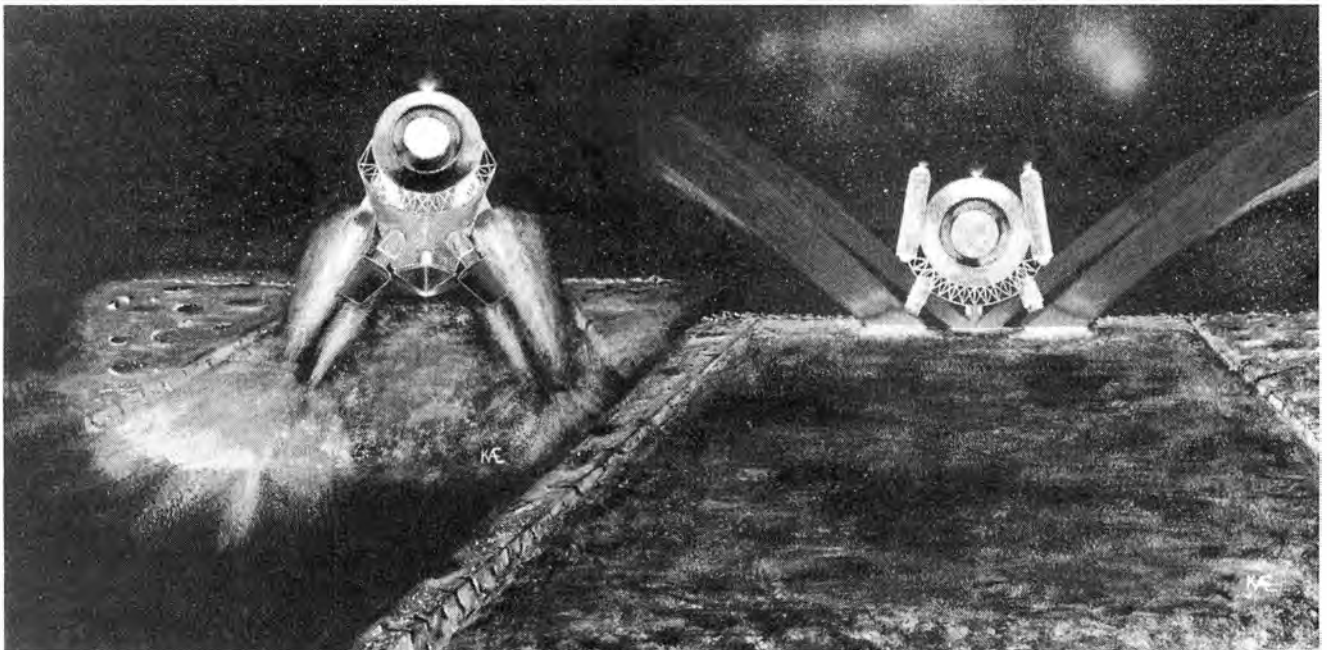

Krafft A. Ehricke

"The climax of the training was a Mars simulation . . . the team made several trips to Moon." The evolution of manned space capabilities envisioned by Krafft Ehricke included the development of Moon, before the journey to Mars. In this painting, he shows "slide landing on the snowy lunar dust," using the surface material to slow the spacecraft, which "minimizes propellant consumption and release of gas into the industrially valuable high vacuum on the surface."

**“. . . X-day, January 1, 2046!
The world held its breath when the flaming
gases erupted out of 61 nozzles to push
the huge ships forward. . . .”**

space station. Jean, accompanied by her fellows and many guests of honor, all in space suits, was sponsor. Radio and television transmitted the ceremony to Earth. The girl threw a slim bottle of liquid helium against the giant frame of the flagship:

“I christen thee ‘Santa Maria.’ May you bear us safely to the shores of a new world, like Columbus’s flagship whose name you are given. We pray that your keen flight through the immeasurable gulf of space may create a new and bright age for those millions of brave men and women to whom we owe the proudest mission of all times: Foundation of interplanetary flight.”

The two carriers were named “Eagle” and “Condor.” The gliders received the names “Enterprise” and “Investigator.”

V

. . . X-day, January 1, 2046!

The world held its breath when the flaming gases erupted out of 61 nozzles to push the huge ships forward, slowly at first, with a power of more than 3 million pounds of thrust.

Even we, to whom a Mars flight means little, can imagine the significance of that moment, which will not be repeated until the first of our new giant scout ships leaves for Alpha Centauri!

The fleet quickly gained speed. Within 500 seconds they stormed over a “runway” of 5,115 miles, and then jumped off into space with a velocity of 20.5 miles per second with respect to Sun.

. . . Escape from Earth was successful. The giant spacecraft strung out along their comet orbit exactly as precalculated. But the men could not yet relax. First the tanks of the flagship and the “Eagle” had to be restored to maintain maneuverability. The corresponding containers were disconnected from the huge frame of the “Condor,” and carefully moved close to the other ships by small auxiliary rocket-motors. Pressure lines were connected and within an hour 180 tons [of fuel] had been pumped into the flagship from two spherical tanks, each 17 feet in diameter. More than 600 tons were transferred into the “Eagle” from seven 22-foot globes. The entire process was completed in four hours and all excess parts hurled away with attached powder units. Everything worked out all right, and when the men retreated into the flagship, the tanker had lost considerable mass. All ships were ready for further action.

Jean had prepared a tasteful lunch which was highly welcomed. There was of course no cook on board of these first space ships. Every man’s weight meant many tons propellant more to be carried, not to mention food and oxygen, which in turn required propellant too for transportation. A job so far

off the purpose of the trip was out of place in the age of chemical rockets, which knew no stricter law than that of the mass ratio.

. . . The ships were drifting apart slowly, because of small moments they had received at the cutoff. Furthermore, a thorough check and, if necessary, a correction as to their position, velocity, and flight direction had to be made. At the end of the first “day” Norton called all men to duty through the intercom. Carlson had received additional observation data and position measurements from Earth.

. . . Jean turned to her work. She evaluated in electric calculators the reports received by Carlson and also her own measurements. She gave Norton all data necessary for the maneuvering of the ships. His orders were fulfilled, with highest precision, as she had trained hundreds of times. The ships turned their sterns in flight direction by means of tiltable control motors. One second full thrust out of all nozzles removed a small velocity excess and corrected a slight deviation from the plane that connected the orbits of Earth and Mars. A further maneuver eliminated the small divergences in the movements of the individual ships. Further corrections would not be made until the errors of second order had been summoned up sufficiently by the time.

. . . The fifth day of their journey found them 560,000 miles from Earth. The gravitational forces of the planet had diminished practically to zero. As it is known from Tisserand’s considerations in his ancient book *Mecanique celeste*, this is the distance where Earth ceases to perturb the flight paths of other bodies in space. From now on they would be subject only to solar forces until 400,000 miles before Mars, when the first perturbations of this planet would become effective. This distance of 560,000 miles marked the proper end of the ascension path and the beginning of the “comet orbits” to Mars. New position checks and corrections were made.

. . . [In] the pale bluish light of the receding Earth and the still undiminished sunny brightness behind, the ships shot forward into the huge dark vastness ahead. Seen from a distance they looked like strange, fantastic deep-sea fishes. The bright light that streamed from the many circular windows on the night side of the gondola made them look like gloomy, staring eyes. Nothing indicated that they were moving at all. Time and motion stood still in complete silence. It seemed as if they had anchored in the center of the universe.

But some hours later the ships entered a tremendously thin cloud of cosmic gas, a delicate, greenish veil that wound up from unfathomable regions somewhere into infinity. Then their tremendous velocity became evident. The black night sides of the huge propellant globes turned into a shade as if covered with scintillating patina, a startling aspect of inexpressible beauty. Space began to unfold its breath-taking wonders before their eyes.

It lasted several minutes only. Then the fabulous space monsters precipitated again into complete emptiness.

“There it is now!” wrote Jean in her diary on this day.

We really are in space. Earth fades away. This is so easily written down; but you should see it. You should

experience this farewell! It is very different whether you look at the stars, lying in the fragrant green grass and dreaming; or whether you see your world as a star among stars while you are floating in the immenseness of space, detached from all the little nameless things that make you feel at home on Earth.

Space skippers are dreamers, all right. They have to be; but only once in a while. Blue skies and silvery clouds . . . seagirt islands . . . a quiet evening in the country . . . dark, green forests and snow-capped mountains . . . be careful, skipper, space gets you!

Norton and his engineers investigated all parts of the ships with a desperate thoroughness.

Pumps, turbines, valves, governors, and other installations were inspected, disassembled, cleaned and reassembled again. Batteries were charged, bolts, connection pieces and welding spots checked. They crept through the nozzles right into the combustion chambers, through the huge cable nets and relay arrangements, exchanging defective parts, testing others. The lack of gravity made it easy to handle masses for which on Earth cranes and many more men would have been necessary. In spite of this, it was tremendous work, but it kept them alert.

Carter examined them all at regular intervals. He experimented on himself and on an assortment of small animals he had taken with him. The men got used to the fact that he disappeared for many hours without telling anybody. He hung around somewhere in space, many miles away from the ships, alone with his animals. But he promised Norton to go only so far away that he could easily recognize the bright green and red cruising lights on the bow and stern of the ships. The lights showed a characteristic flickering modulus so that they could easily be recognized among the myriads of stars.

Brooks and Foster devoted themselves to their physical and chemical experiments. Moreover they checked the air conditioner and the water regenerative plant which regenerated the moisture from the stale air for use as cleaning water. They cooperated with the engineers in periodical temperature control of the cabins and propellant containers. Together with Dr. Carter they supervised the hygienic conditions in the gondola. Jean plunged deeply into her astronomical observations and regular position measurements.

. . . Norton awakened with the vague feeling that something was wrong. He would have been unable to explain the unrest which brought about the interruption of his sleep, although he was still tired. First he listened, but there was no irregularity in the familiar pattern of damped sounds which came from the various auxiliary machines.

He looked through the window of his cabin and saw a



NASA

"Norton and his engineers investigated all parts of the ships with a desperate thoroughness." Throughout the many-month journey to Mars, constant maintenance and repair were required, Ehricke reports. Here, in January 2003, International Space Station Expedition 6 science officer Don Pettit performs in-flight maintenance on the treadmill used by the crew to counteract the debilitating effects of weightlessness.

figure floating several hundred feet away. The figure had a telescope mounted before its helmet. He called the person through the intercom, but got no answer. This man had obviously forgotten to switch his receiver on, although this was a strict order for everybody who worked outside the ship.

Norton was just turning away from the window, when a sudden movement of the figure stopped him. The man drew his reaction pistol—the instrument by which the spacemen drove themselves around outside the ships—and shot, obviously without placing the instrument in a correct manner. Something seemed to have frightened him terribly, since he whirled around as if mad, thereby approaching the ship much slower than possible.

Norton jumped out of the cabin and hurried along the gangway toward the air lock which the figure tried to reach. He wondered why the guard did not call the person through the intercom. Where was the guard?

A body bounced against the outer lock door. Norton pressed the button of an electrical emergency valve which emptied the lock room in a second. No time now for pumping the air back into the container. The gas shot into the emptiness as a straight, blue-white jet. Norton heard a thin remote voice calling on the gangway loudspeaker, but did not register. He saw through the peephole the figure enter and close the outer door. He opened the "Air-In" valve and unlocked the inner door. The man staggered into the gangway.

It was Winter. He snatched his helmet off. Norton looked into a pale, horrified face, the eyes wide opened.

"Ye Gods! What's the matter Winter!"

"Ghosts!" exclaimed Winter, trying to catch his breath.

"There are ghosts around our ships!"

". . . A big celestial body is approaching the ship . . . Nature of body unknown. Certainly no comet, at least I can see only one single body, no cluster . . . size is hard to estimate, since distance unknown. Seen with the naked eye it looks like a silver dollar from three feet distance. Body has grey-greenish shade. Irregular form . . . seems to rotate slowly . . . partly illuminated as it is now it looks like an ugly mask through my telescope . . . velocity of approach is moderate . . . direction of motion seems to be rather parallel to that of the ship, but I may be wrong. Immediate measurements necessary!"

"That's strange," murmured Jean, moderate velocity of approach . . . parallel direction of motion.."

She disappeared into the control room.

"Carlson, Davis," ordered Norton, "don your space suits and take the carriers over. Hang on! We might have a traffic jam."

Jean called Norton through the intercom. She did not turn from the observation instrument when he entered the control room.

"I think my tacit assumption was correct. We have detected a new asteroid. I'll give it the number 3350 until we decide on a name."

Why do you think it's an asteroid?"

"The body has a diameter of about 4 miles. That's too large for a meteorite; and, as Carter observed correctly, it's a single body, no comet. Present distance approximately a hundred miles."

Norton observed the asteroid through a second telescope. The general outline was very irregular, some parts of the periphery seemed to be even jagged.

"It's only partly visible."

"Yes, approximately last quarter. It moves between us and Sun and probably will be invisible when passing."

"That's bad. How about the motion?"

"It's orbital plane must be inclined toward ours; I cannot say right now how many degrees. It moves somewhat faster than we do. Velocity excess less than a quarter of a mile from angular measurements. It will pass us in about six minutes. The small velocity difference indicates that it's remotest point from the Sun, the aphelion, cannot be much farther than Mars distance, although in a different plane."

". . . Attention all ships!" said Norton from the control room. "The body will pass at a small distance in about five minutes from now. Everybody has to don his space suit!" The distance between the ships was approximately 1 mile, the flagship flying between the two carriers. Norton gave the order to disperse so that the distance of both ships from the flagship was about 10 miles. This gave enough room for eventual maneuvers of a single ship which might run into the danger zone. The relative velocity of the asteroid with respect to the fleet was low enough to allow maneuvers.

They waited in their space suits. Jean made some more position measurements and, drawing a line on a large chart which showed their own flight path over the various star constellations, she said:

"Extrapolating the measured position coordinates, this is roughly the line of motion of No. 3350. It's a pity that we

weren't alerted earlier. As things are, I cannot get it more correctly now. The asteroid will pass me within a sphere of 50 miles radius around the flagship. It seems as if the inclination of its orbital plane against the ecliptic plane in which we move is very small, not more than 10 degrees."

Everybody heard Jean's announcement through the intercom. She called again:

"Attention all ships! Distance of asteroid about 30 miles now . . . 20 miles. . . . It'll pass us in a minute!"

The quickly approaching asteroid flung its huge shadow on them dreadfully. It suddenly became completely dark around.

"Asteroid eclipses Sun!" called Jean. "Attention Davis! It passes on your side!"

"Hope it doesn't smash our propellant supply." growled Davis.

This was the last observation. The body was a giant shadow slipping over the starry background. They held their breath. . . . It passed by . . . no sound in the intercom . . . nothing had happened.

Sunshine flooded again through the windows on the day-side.

"It passed quite close to me! Guess it was less than a half mile!" cried Davis. "Hey! This thing is pretty radioactive! My outboard microammeters indicate strong alpha and beta activity. No slow neutron radiation announced by string electrometer of boron chamber."

"That's interesting," replied Norton. "Our counters show

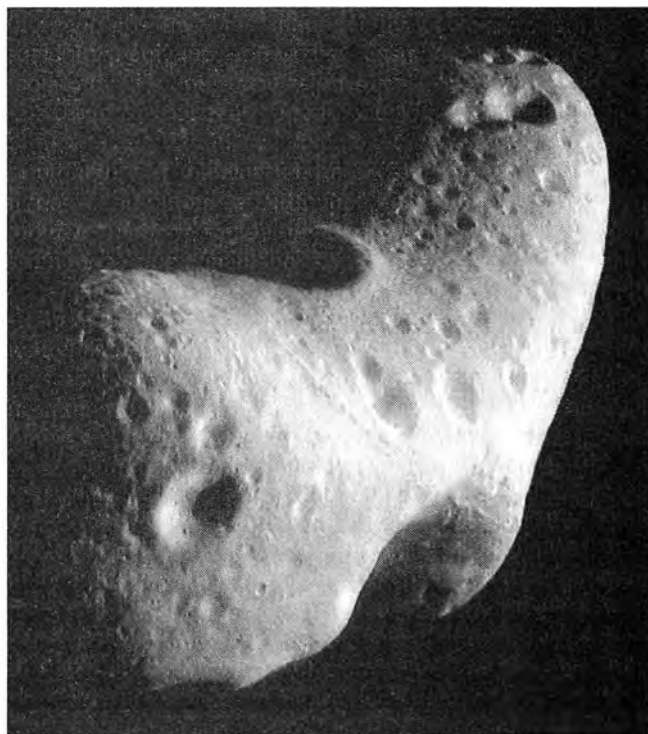

NASA/Johns Hopkins University Applied Physics Laboratory

"Norton observed the asteroid through a second telescope. The general outline was very irregular; some of the periphery seemed to be even jagged." Asteroid Eros—quite irregular—was photographed up close, not by a human crew, but the Near Earth Asteroid Rendezvous spacecraft on June 5, 2000.

some activity too. Did you recognize something on the surface?"

"Not when it passed. Now it's already a bright sickle again which increases quickly. Surface color is essentially a very dark gray. Some greenish spots are perceivable. Surface is very rifted."

The body became steadily brighter now in spite of its increasing distance. A growing portion of the illuminated surface became visible.

"Why not pay a visit to No. 3350!" called Norton suddenly. "I think we shouldn't miss such a rare chance. Who comes with me?"

"I'll go with you," said Foster quickly.

"Okay. We'll take our L-rockets. Dr. Tudor, you take over meanwhile. Come on Foster!"

The L-rockets were quickly separated from the frame. In less than a minute the tiny ships flung out and followed the body with full steam. The L-rockets were equipped with a variety of radiation detectors, because they were supposed to serve as scout ships besides their main purpose to be emergency craft.

Several minutes later they flew parallel to the asteroid, keeping carefully on the sunny side. It was an impressive aspect for these newcomers in space to see that huge body floating close to them in empty space.

"Do we land?" asked Foster.

"First let's check on radiation."

They moved as close as 500 feet to the body. The audible detectors responded strongly.

"No indication of slow neutrons," observed Foster. Expose nuclear film for fast neutrons!"

They approached the body as close as 100 feet. The intensity of the showers became startling. The neon bulbs, visible indicators, flashed as if mad. The crackling of the audible devices turned into a continuous rustling. Deadly rays of immense intensity blazed around their ships.

"We have at least 10,000 milliroentgen gamma ray intensity outside!" called Norton. "Look on your dial. Corpuscular radiation intensity is several rep. It's impossible to leave the ships."

"What a pity that we aren't equipped with lead-lined space suits."

"Our order from Earth is to explore only, Foster. We'll come back and attack this dangerous fellow with more adequate means. Anyway, it's important to know about the existence of such power sources in space."

"Okay, let's move out of the danger zone. The air in our ships is already very ozonized by secondary radiation. The ships are getting radioactive." They retreated as far as one mile away from the body. The radiation became tolerable. They made observations and took photographs of the surface. At the same time Jean made pictures of the asteroid and the ships through a 20-inch Schmidt telescope which gives sharp definition over a very large field to be photographed. These were really memorable photographs of a decisive opportunity that had brought them a most important discovery.

An hour later the little rockets hooked smoothly on the flagship. With regret they observed the interesting visitor disap-

pear into the depths of space. Again they were alone. Carter examined Norton and Foster closely when they came back, but found no signs of contamination. He ordered them, however, to change their space suits and abandon the old ones, because these showed a slight radioactivity, especially the metal parts, such as helmet connections, shoe soles, breath package containers, and others.

"Well," asked Norton, "which name do you propose for No. 3350. You are the actual discoverer after all."

"All right," laughed Carter. "I think its predominant character makes it easy. Let's call it Radiant."

...When Norton came back to the control room his busy navigation officer had already a rough idea of the orbit of (3350) Radiant.

"She revolves in a rather circular orbit of small eccentricity. Perihelion is in about 0.9 astronomical units. Length of perihelion is approximately 190 degrees. Remotest point from Sun is about 1.7 astronomical units, that is about a 160 million miles. Inclination of her orbit against the ecliptic is close to 9.5 degrees."

"How do you explain the high radioactivity?"

"That's not easy, Norton. Concluding from the elements found in meteorites on Earth, the nature of (3350) Radiant is a surprise. Only negligible traces of some radioactive elements, such as radium and thorium have been detected in meteorites."

"Okay, but Radiant is an asteroid."

"Which means that she is probably the fragment of a planet that has been torn to pieces by Jupiter a long time ago. If this is true, we are tempted to assume that this planet should have had essentially the same composition as Earth. But our knowledge about the abundance of radioactive matter in planets is still very superficial. We only know that concentrations as we detected then on (3350) Radiant do not occur on the surface of Earth."

"How about the composition of the interior of our planet; I mean the abundance at radioactive elements."

"At least we know that the interior contains the heaviest parts, especially the heavy metal core. But it's improbable that we would find these parts enriched with uranium or thorium, although they are very heavy. Decisive for the depth in which to find an element, however, is not its atomic weight, but rather the specific weight of the phase into which that element turns as a result of its inherent chemical properties. Uranium and thorium have high ion volumes. This fact and their affinity to oxygen, which is stronger than that of iron, explains why these heavy elements tend to accumulate in the outer shells."

"Well, then this would mean that the broken planet must have had a much higher surface abundance of radioactive elements than Earth?"

"Not necessarily. The local concentration only might have been different. Besides, what do we know yet about the actual radioactive content of (3350) Radiant? Our investigation had to be very superficial, unfortunately. The dark parts might consist of a kind of pitchblende, containing very much U_3O_8 , but they might as well be harmless slate in its majority. The greenish spots might exist because of strong UO_3 content or have some other reason. Anyway, I guess this asteroid will

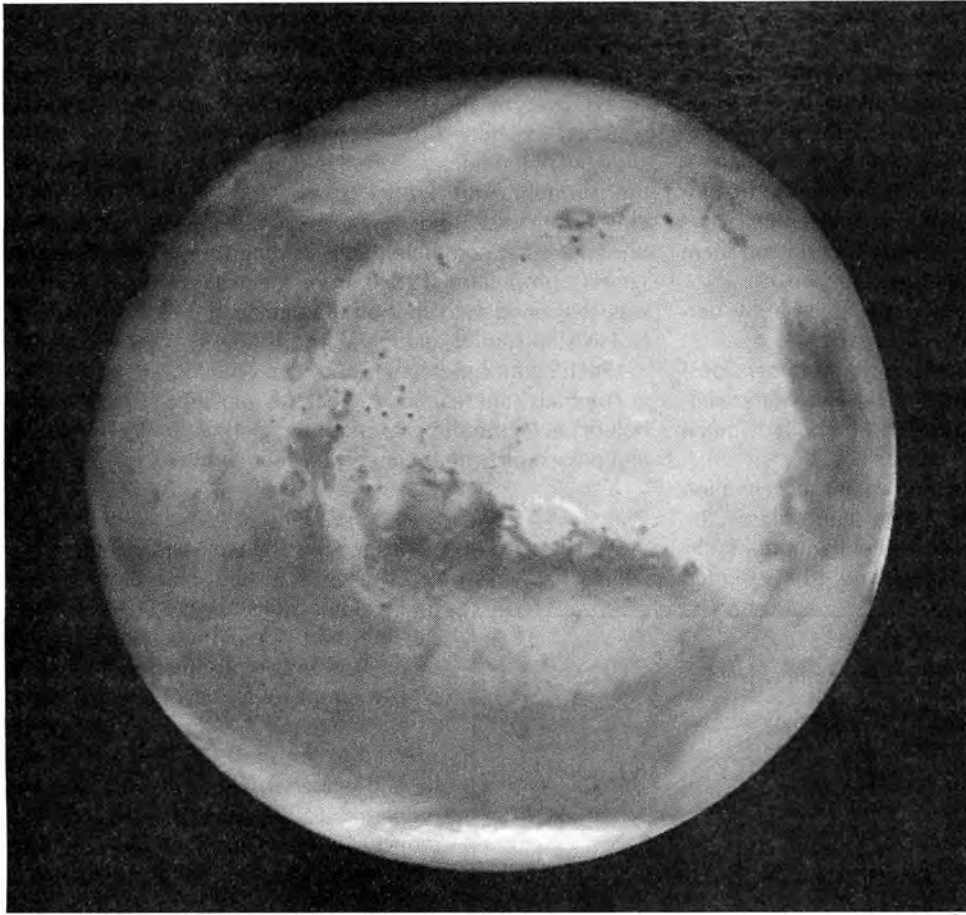

NASA

"MARS! Its reddish disc flung out of the depths, shining in the damped light of a remote Sun." This full disc of Mars was taken on June 10, 2001, by the Mars Global Surveyor spacecraft. It is a view not yet seen firsthand by human eyes.

become a first class research object for further space expeditions. She might help us to bring some light into the question of the distribution of radioactive matter in the Solar System at the time of its formation, probably by the interaction of three large bodies."

"Not to forget the technical importance such an asteroid might gain. I hope we can convince the people on Earth how stimulating space travel will become for all sciences."

"You certainly are right," agreed the astronomer. "There are no sensational alien civilizations to be expected by exploring our Solar System through space flight, but an amazing variety of basic questions and answers that affect the very foundation of our own existence."

VI

... MARS!

Its reddish disc flung out of the depths, shining in the damped light of a remote sun.

... It was high time to transfer the food supply from the "Eagle" to the tanker. Norton ordered Brooks and Foster to this job. He and Jean were fully occupied with preparations for the imminent capture maneuver. Davis and Carlson, detached and prepared the gliders "Enterprise" and "Investigator." Three hours later everything was ready. Norton directed the fleet from

the control room as usual.

"Attention all ships! In 30 minutes we start picking up speed. Our present distance from Mars is 50,000 miles. Mars will now pass ahead of us. Angular measurements of surface objects indicate that our perturbations from the planet's mass correspond to those accounted for in the calculations. Our position, as corrected, is as exact as it can be. All orders must be obeyed precisely now. If so, we'll hook on the planet successfully!"

The ships flew in close formation. To the left of "Santa Maria" were "Enterprise" and "Investigator," piloted by Brooks and Foster. To the right hung Carlson with the "Condor." Slightly above their common plane floated the "Eagle" with Davis. He was the best pilot in the crew and drew the most difficult tasks. He flew the tanker away from Earth when the ship was heaviest, and now had to land the carrier on Phobos.

"Distance 45,000 miles!" called Jean without turning her face from the instruments." Mars is passing ahead of us

now. Look . . . at that!"

Mars was already eight times as large to the naked eye as Moon when seen from Earth. Two bright spots were visible at the sides of the disc, the moons Phobos and Deimos. The men stared silently at the planet, which slowly moved ahead, unveiling more details with every minute.

... The last minutes were tension-packed silence. Mars now lay to their left. It was no longer a disc, but a huge globe that arched before their eyes.

"Attention all ships! Start pressure-fed motors! One second . . . two. . . ." Tiny, glowing jets emerged from auxiliary motors to yield a small acceleration which pressed the large propellant masses in the main tanks toward the suction pipes of the pumps.

"Turbines on! Full throttle!!"

Fiery jets burst out of all power plants. With relief, the men felt their own heaviness again. Davis disappeared in upward direction. The ships jumped forward like panthers to catch the planet ahead.

Jean observed the sky ahead through her space-fixed Schmidt. For the first time since they had left Earth, part of the stars were eclipsed by a giant sphere again. The full phase of Mars that was visible when the planet passed them outside

their own orbit had shrunk to a slim sickle, because they approached its night side.

. . . She turned her telescope around 180 degrees to check the star field around the ships. It was still necessary to be watchful in all directions. Yet her movement was routine rather than that of genuine concern.

There she saw it. A sudden alarm paralyzed Jean so that for a second she couldn't utter a cry. Among the familiar stars flashed a light, bright and dreadful. A body shot toward them like a projectile aimed to destroy their fleet,

"Attention all ships!" she cried mechanically, hardly perceiving her own voice. . . .

"A body from behind! Coordinates zero in all dimensions! Negligible lateral component! Probably unknown Mars satellite! Disperse . . . disperse I say! Quickly!! The body is much faster than we."

They flew with a predetermined constant acceleration which left ample reserve in power. Upon Jean's alarm, the ships tilted all available motors and spread out with full throttle. The tremendous lateral acceleration would have hurled

them off their seats if they had not been strapped in. The body grew with startling abruptness.

A sudden cry: "The food containers! Our food!" They stared over to the tanker, speechless, horror-stricken and watched the huge boxes, each piece many tons in weight, slide out of the frames. Part of the mounting had broken under the sudden, unforeseen lateral acceleration. The cases crashed against pipelines and connection bars, destroying one motor set completely, the feeding lines of another. Self-igniting propellant flamed from the leaking pipes. Carlson was alert enough to shut off the damaged motors immediately. His ship started rotating about its lateral axis.

"Pitch control motors on, Carlson! Quick!"

The body had reached the fleet. It appeared like a thunderbolt between the ships, a smashing, glaring fire line in the sky, and passed off with inconceivable suddenness.

VII

. . . They had accomplished the flight to Mars, but there was neither happiness nor satisfaction in this achievement. . . . A few welding spots and an unknown little satellite had spoiled everything at the moment of accomplishment. That malice of fate simply was beyond comprehension.

A radiogram from Davis, reporting that he had landed safely on Phobos and was preparing to establish the big research reflector of the "Eagle," emphasized only the bitterness of the general situation.

Norton, together with Carter, Jean, and Carlson made an immediate investigation of the remaining food. They found that not everything had gone astray. At the mountings of the lost boxes they investigated the broken welding spots. The weakness of these spots could not have been perceived earlier, since the food was hooked on the "Eagle" before. Nobody was to blame. If not for the little satellite and the sudden lateral acceleration, their bad qualities even might not have become fateful at all. And later . . . when they had started back, the remainder of the food would have been in the flagship anyway, and then the devil might have cared for the welding spots.

That capture maneuver on Mars actually was the only opportunity for these spots to break and, the deuce, they broke.

. . . Jean calculated feverishly to determine the orbit for the return. Norton instructed Davis of the general situation and advised him to make as many photographs of the Martian surface with the powerful magnifying telescope as possible until he would be called back. Norton could not allow anyone else to join Davis in his interesting job, because

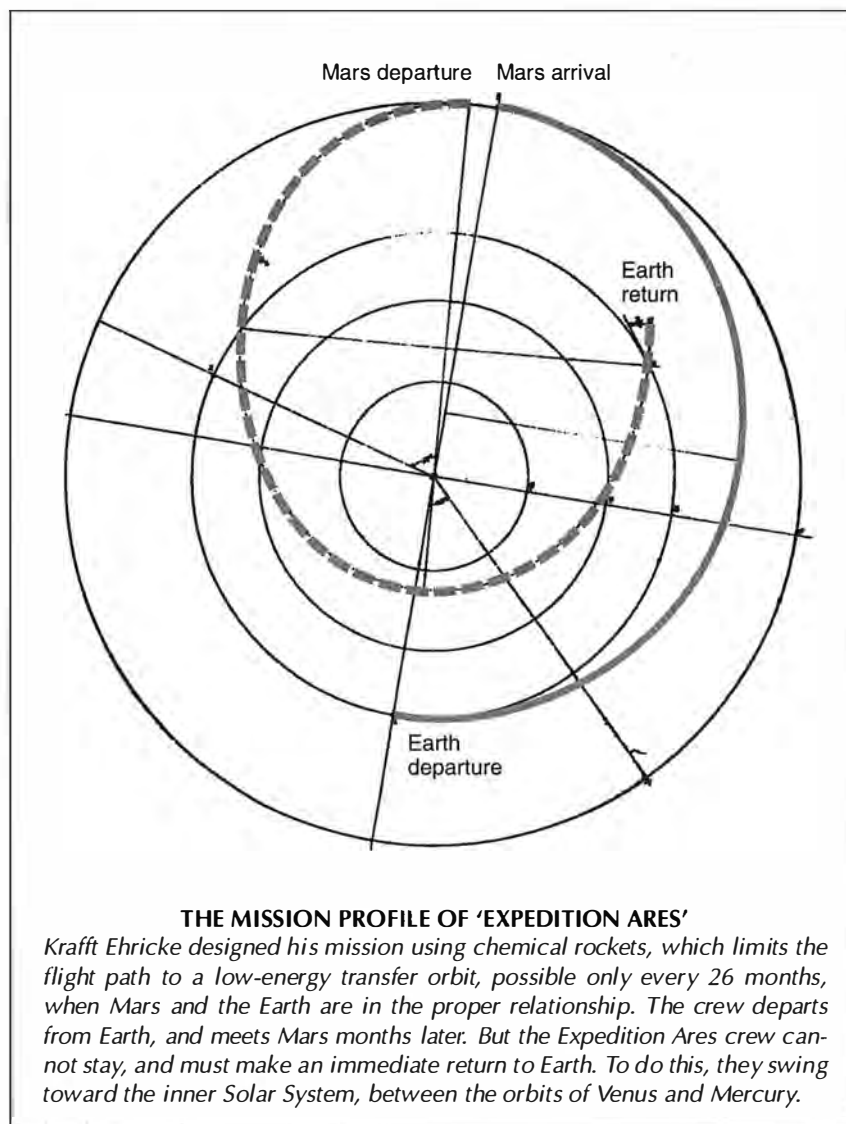

THE MISSION PROFILE OF 'EXPEDITION ARES'

Krafft Ehrlicke designed his mission using chemical rockets, which limits the flight path to a low-energy transfer orbit, possible only every 26 months, when Mars and the Earth are in the proper relationship. The crew departs from Earth, and meets Mars months later. But the Expedition Ares crew cannot stay, and must make an immediate return to Earth. To do this, they swing toward the inner Solar System, between the orbits of Venus and Mercury.

“There are no sensational alien civilizations to be expected by exploring our Solar System through space flight, but an amazing variety of basic questions and answers. . . .”

they could not afford to spend a single drop of propellant for such purposes.

Their prospects were critical but not hopeless. The remaining food and water would last for 230 days, if strictly economized. This dictated a flight path back to Earth which would require more energy than was available. Observation of the dark areas of Mars by Davis confirmed what they knew before! There was no possibility to sustain their life on Martian ground. They had to return quickly or to perish.

The L-rockets were their only chance of survival. Jean calculated a cruising path which represented the optimum under the circumstances. They had to jump off the Martian orbit, decelerating approximately by 4 miles per second, retrograde to the planet's direction. They would fall then, toward Sun, and cross the orbits of Earth and Venus until they approached within 44 million miles of Sun. Then they would swing back again and finally approach Earth at tremendous velocity and in a direction declined by 33 degrees toward the tangent of Earth's orbit.

“It's a mad trip,” said Jean as she announced the results of her calculations, “but we have no choice.”

Norton informed Davis to leave everything behind and to join the main fleet with the L-rocket the “Eagle.” He ordered all propellant containers transferred from the “Condor” to the flagship. New mountings had to be provided and the men worked madly, since they had only 10 days before the start if they were to meet Earth at the second cross point. When all spheres were attached, one day remained to throw all dispensable parts out of the flagship and reduce its mass as much as possible.

When all was ready they assembled in the observation room. Norton gave the final directions:

“Friends, we are going to try a desperate jump across the inner Solar System to save for Earth what is left of this sad expedition. In just 224.6 days, if everything goes okay, we will enter the gravitational field of the Earth. Keep your nerve . . . especially during the perihelion transit. That will be the tough spot. . . .”

. . . The jets roared. Mars fell away into the night. The ship drilled through space toward the blazing center of the Solar System.

. . . The Sun grew in size as they drove steadily toward their perihelion. Finally the disc was 50 percent larger than seen from Earth. An overwhelming flood of light dazzled their eyes, though protected by dark glasses. Norton had stopped any work outside the ships since they had passed Venus. The heat became unbearable. As a last resort they closed all hatches, but the reflector steam plant in the outside frame burst, paralyzing the generators, and some had to be opened again.

Norton gave the ship a rotation to provide at least a tempo-

rary shadow for all parts, especially the propellant tanks, the oxygen and water containers. Although the ship was heavily insulated and all vital parts had been covered with a highly reflected surfaces, the temperature rose.

. . . The ship hurled between Earth and Moon. The “Santa Maria” was nearly completely dismantled. Even the gondola in which they lived was doomed to be thrown away. This was not possible however, without mounting some indispensable devices into the frames. Among these, the most important were the remote-control arrangement of the power plant and the radio set.

. . . They stormed toward the right side of the giant Earth globe. Carlson's emergency calls were caught by the large receiver on Space Station I, and plunged the world into one of its greatest sensations. The ships on all seven seas, cities and villages on all continents, were notified. The radar seekers on the station turned their beams, and the telescopes their reflectors, toward the approaching ship. The station announced that 12 rescue ships had been alerted and were ready to take off.

Starving, dying of thirst, hardly humans any more, the crew of the “Santa Maria” squatted in their L-rockets. The flagship was virtually a wreck. Among the many parts, even two of the four motors had been jettisoned with the gondola. Only Norton remained outside among the frame bars to burn the last propellant in a first, but completely inadequate acceleration.

They were 2,000 miles from Earth when Norton turned the motors on. The propellant burnt out in 174 seconds. The once proud “Santa Maria” was an empty wreck now and had to be abandoned. Norton jumped into his L-rocket and gave the last orders;

“Abandon ship! Good luck to all of you! We'll meet on the space station!”

Carter with his heavier ship remained behind and was soon lost from sight. Everyone had to fight himself alone through the last part of the journey. Many days later they learned that he had circulated around Earth too often, each time contacting the atmosphere. He dropped finally below his local circular velocity and had to go down to the ground. The lookout on a luxury liner between San Francisco and Honolulu saw the parachute descend. A rescue boat fished Dr. Carter out of the Pacific. He later said that he never had enjoyed a bath so much in his life! The captain had to confine him to his own cabin when the enthusiastic passengers learned that he came direct from Mars.

Carlson made a perfect flight and was first to arrive at the station.

Davis had bad luck when, one of his fuel lines broke. He had to cut off his motors immediately and plunged into the atmosphere with too high velocity. This broke one wing from the L-rocket and as Davis whirled into space again he realized that he could not risk a second transit through the atmosphere. He was thrown into an elliptical course, as he found out from position calls, whose apogee was 500,000 miles away from Earth. This made things critical as his oxygen supply would have been exhausted long before he had completed one revolution through that ellipse.

He studied his position tables and found that he would pass

THE KRAFFT A. EHRICKE
INSTITUTE FOR SPACE DEVELOPMENT



The Krafft A. Ehiricke Institute for Space Development, founded in 1992, is dedicated to preserving and disseminating the work of Dr. Krafft Ehiricke, in order to provide the technical and philosophical foundation for the future progress of space exploration. The Institute has donated Dr. Ehiricke's collection of writings and research materials to the National Air & Space Museum in Washington, to make this treasure available to the public.

The Institute plans to prepare for publication a selection of Dr. Ehiricke's writings, additional unpublished manuscripts, and his book, *The Seventh Continent: Industrialization and Settlement of the Moon*.

Contributions to the Krafft A. Ehiricke Institute for Space Development are tax deductible.

For more information, please contact the Institute at: 4629 Cass Street, Suite 216 San Diego, Calif. 92109
KrafftEhirickeInst@cglobal.net

close to Moon. Quickly determined, he repaired his damaged fuel line, threw everything dispensable overboard and radioed to the space station that he was going to hang himself on Moon.

When approaching Moon, Davis spent his last propellant in a desperate capture maneuver. He broke down when the last fuel drop was burnt. With glowing nozzles the lonely ship circulated around Moon in a slightly elliptic orbit, fifty miles above the craters.

The rescue party of "Space Station I" found Davis unconscious but still alive. His breath pack was empty.

... When they entered the rescue ship, Jean knew that this was not the end, but the beginning of a great story. . . .

For Further Reading

Krafft Ehiricke, 1981. "Industrializing the Moon: The First Step into a New Open World, Part I." *Fusion*, Vol. 5, No. 2 (December), pp. 21-31.

_____, 1982. "The Extraterrestrial Imperative: Why Mankind Must Colonize Space." *Fusion*, Vol. 5, No. 6 (December), pp. 18-24.

_____, 1984. "Industrializing the Moon: The First Step into a New Open World, Part II." *Fusion*, Vol. 6, No. 1 (May-June), pp. 46-55.

Marsha Freeman, 1993. "Krafft Ehiricke's Extraterrestrial Imperative," in *How We Got to the Moon: The Story of the German Space Pioneers*. (Washington, D.C.: 21st Century Science Associates).

_____, 1994. "A Memoir: Krafft Ehiricke's Extraterrestrial Imperative." *21st Century* (Winter), pp. 32-37.

_____, 1998. "Krafft Ehiricke's Moon: A Lush Oasis of Life." *21st Century* (Summer), pp. 19-33.

Photocopies of these six articles are available at \$30, postpaid from 21st Century.

CHALLENGES OF HUMAN SPACE EXPLORATION

SPRINGER PRAXIS SERIES IN ASTRONOMY AND SPACE SCIENCE

by **Marsha Freeman**

Associate Editor, *21st Century Science & Technology*

The real story of the accomplishments of the United States and Russia aboard the Mir space station.

Foreword by Dr. Michael DeBakey.

300 pages, illustrated

**SPECIAL
DISCOUNT FOR \$30**
21st Century readers

(list price \$45)

Mail check or money order (U.S. currency only) to:

21st Century Space Books P.O. Box 1951, Dept. T, Leesburg, VA 20177

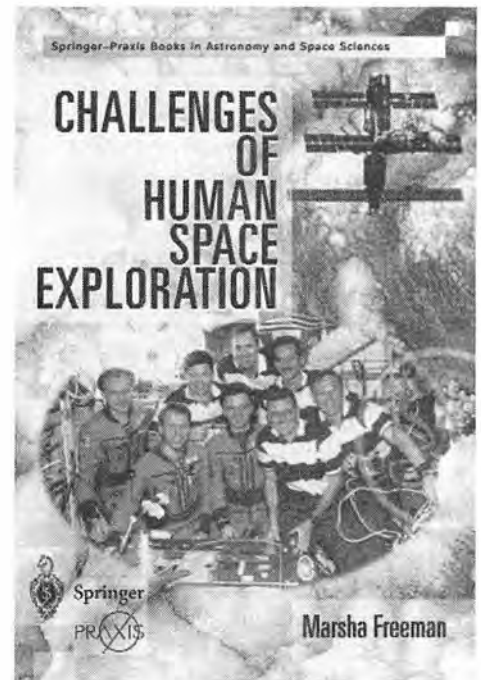

Shuttle 'Fix' Means a Change In Economic Policy Axioms

by Marsha Freeman

Immediately after the Columbia Space Shuttle's catastrophic accident Feb. 1, the NASA Administrator and President Bush pledged that NASA will find the problem, fix it, and return to flight. But going back to the way things were, will not fix the problem.

For nearly 40 years, the wrong criteria have been used to make decisions about space policy. While Presidents and Congressmen make self-righteous statements about their commitment to space exploration—especially at times like this when the public expects it—they are married to ideologies that preclude their fighting for the space program the nation requires. What has to be "fixed" is the cultural paradigm shift this country has suffered since the Kennedy years.

The risk of accidents is inherent in the extreme environment of space travel, as it is in any other experimental or exploratory venture. Nothing can be made perfectly safe. But as is readily acknowledged by the astronauts who take the risk, there is no other way to further the human knowledge gained through space exploration, than to do it.

Although the risk cannot be eliminated, it should be minimized. One way is to constantly examine and re-examine the physical state of the vehicle and other assets involved—especially as they age and wear—and to do the same with the assumptions made about every aspect of operation of their systems. Relying on mathematical models or data that do not take into account

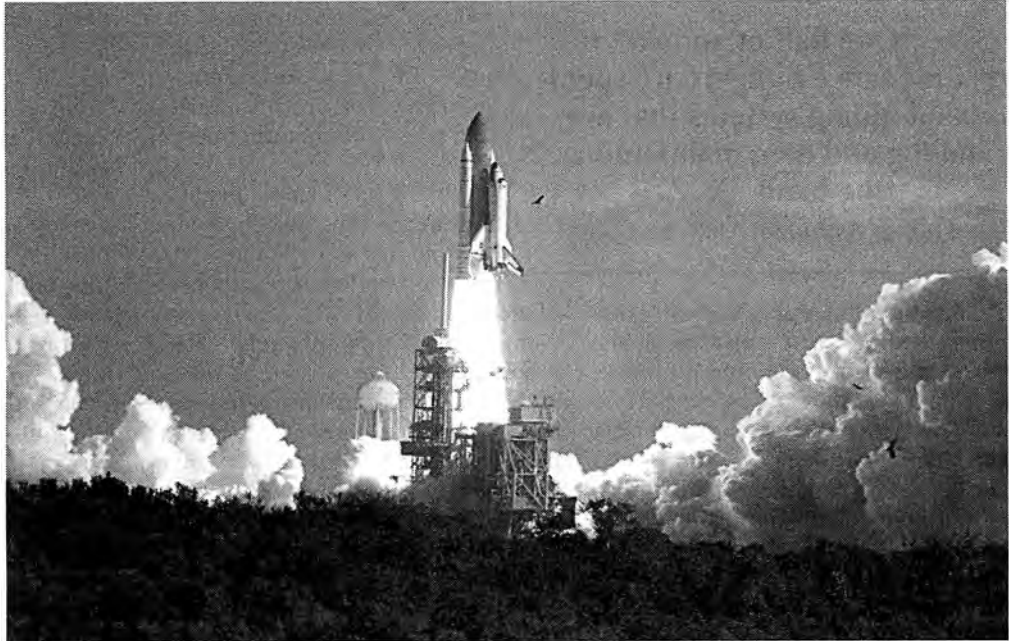

NASA

Long before the Feb. 1 Columbia accident, budget cuts and privatization had made the Shuttle program what astronaut Brewster Shaw, NASA director of Space Shuttle operations, called "a generic failure waiting to be discovered."

changes over time, will not improve safety.

A second way to minimize risk is to incorporate leading-edge technologies into spaceflight systems, with the goal of a high rate of technical attrition in existing assets, as they are replaced, retired, or shifted into less critical functions. The Shuttle system's problem is not its age as such, but that its 1970s technologies have been surpassed by innovations that could improve its performance, and make the Shuttle safer.

Space Exploration as 'Science Driver'

The Space Shuttle program itself is only a small part of the space program the nation requires. Four decades ago, President Kennedy set the space agency on a clear and visionary mission—to land a man on the Moon. He

told the Congress in May 1961 that it would be expensive, and warned them that if Congress were not willing to fund it, it should not even be attempted. He formulated an investment tax credit, and other fiscal measures, to vector private sector resources toward leading-edge, high-technology R&D and manufacturing investments that would support the exploration of space. Kennedy's space program contributed substantially to more than a decade of technological innovation, leading to dramatic growth in the economy of the United States.

The 1963 assassination of President Kennedy, and the takeover of U.S. policymaking by a grouping completely opposed to scientific and technological progress, forced President Johnson to

abandon plans for a post-Apollo Moon/Mars program. By the late 1960s, under President Nixon, aerospace workers were being laid off by the thousands. An entire branch of industry devoted to supporting the space program, was being shut down, even before the last flight to the Moon in 1972.

In place of the commitment to

“One half of annual maintenance budgets are spent band-aiding systems that are failing and then maintaining the band-aids.”

—Former Astronaut Mike McCulley

space, which the Moon-Mars program represented, we got only the Space Shuttle program. We would no longer be able to venture to Mars, but we would be able to fly to near-Earth orbit with some consistency. There was nothing wrong with that, had it been a part of something larger. But it was not.

One should view the discussion of the problems of the Space Shuttle and what must be done to fix it, from this standpoint. There is no small fix worth fighting for. There is only the big solution—a return to a visionary national program for space exploration.

Sabotaging Shuttle Safety

After the vision of a long-term Moon-Mars manned space exploration was downsized into the Space Shuttle (and later, the International Space Station), these programs were constantly under the budget axe.

For years, NASA engineers have been well aware of the need to update the 1970s technologies of Space Shuttle systems, and to carry out upgrades to improve safety and performance. In addition, every year, the Aerospace Safety Advisory Panel, established after the 1967 Apollo fire, prepares an independent report for NASA on flight systems' safety.

In 1992, a decade after the Shuttle started flying, NASA took a new initiative to assess and improve the safety and reliability of the Shuttle, compiling a list of proposed upgrades. But one year

later, the Clinton Administration's agreement with Russia for the Shuttle to visit the Mir space station, required that money for the Shuttle be spent, instead, on modifications to the orbiters to carry out that program.

Meanwhile, the budget for the Space Shuttle program was declining. Between 1993 and 1999, the Shuttle budget was cut from \$3.5 billion per year to \$2.9 billion, in real-year dollars. In constant dollars, this amounted to a 40 percent cut, over that time period, which led to the deferral of upgrades, and substantial cuts in both NASA and contractor personnel.

In 1996, all proposed modifications to the Shuttle fleet were put on hold because of the budget squeeze. Under the “leadership” of Vice President Al Gore—and with the enthusiastic support of NASA Administrator Dan Goldin, a former TRW Corporation executive—the space agency became the White House's poster boy for the policy of “reinventing government.” In the White House's attempt to “balance the budget,” and outdo the lunatics leading the Republican “Conservative Revolution,” the nation's future in space was being sacrificed.

NASA managers, under heavy pressure from the Congress, discussed a future replacement for the Shuttle, which would be designed, and eventually run, by the private sector. Even though everyone was aware that designing, building, and testing a new manned space-launch system would take years, the accountant's mentality dictated that money would not be spent on the Shuttle system if it had only a limited lifetime.

But in 1999, NASA made clear the Shuttle would, and should, be flying until at least 2012. The consequences of lack of investment in the Shuttle fleet were then becoming more obvious. At a Congressional hearing on Sept. 24, 1999, called to discuss the cause of frayed wires and a hydrogen fuel leak in Columbia, former astronaut Andrew Allen, director of Space Shuttle development for the industry contractor United Space Alliance, stated that “the Space Shuttle upgrade program has been delayed and underfunded for years,”

and that this was contributing to the problems. The discovery in August of the frayed wires had grounded the entire orbiter fleet.

Characteristically, members of the House Science Committee responded that there were not enough funds for all the upgrades that NASA wanted, and Space Subcommittee chairman Rep. Dana Rohrabacher (R.-Calif.) said NASA should speed up the process of “privatizing” the Shuttle, and “incentivize” the industry contractors to make the upgrades!

NASA began an internal review of needed Shuttle upgrades in Fall 1999, and in February 2000, in the agency's Fiscal Year 2001 budget request, the agency identified nine critical safety upgrades to be implemented across the four-orbiter fleet. The list included the replacement of the Shuttle's hydrazine-powered Auxiliary Power Units (which are vulnerable to leaks, fires, and even explosions), with electric units used in military jet fighters, costing a total of \$224 million. An advanced health-monitoring system for the Shuttle's three main engines was included, for \$108 million, to prevent an inadvertent engine shutdown in flight that could trigger a catastrophic explosion.

NASA proposed redesigning combustion chambers and nozzles, at a cost of \$400 million, using more advanced designs and manufacturing processes pioneered by Russian aerospace companies to reduce the number of welds, and potential failure points, in the Shuttle engines. The total request by NASA for Shuttle upgrades in the Fiscal Year 2002 budget came to \$488.8 million.

Equally important was the request for increasing the skilled staff. The safety panel NASA had convened in September 1999, warned in its report in March 2000, that efforts to reduce the cost of Shuttle operations, primarily by reducing staff, had led to an erosion of risk management. Shuttle employees were under “increasing levels of stress.” The panel recommended that the size of the Shuttle workforce be increased, with additional NASA employees, rather than contractors, thus echoing a similar recommendation of the Aerospace Safety Advisory Panel, which cited

"consistent and repeated reports . . . of critical skills shortages" in the space agency.

Between 1996 and 1999, NASA's Space Shuttle workforce had shrunk from about 3,000 to about 1,800 employees. The total NASA and contractor workforce perform about 1.2 million separate procedures to prepare a Space Shuttle for flight, and the NASA cuts had eroded the agency's ability to perform adequate oversight to ensure the safety of the Shuttle.

By 1999, both the stress on the workforce and threat to Shuttle safety had already been noted, even by "market-oriented" NASA Administrator Goldin, who admitted that cuts to the program had gone too far. In its Fiscal Year 2001 budget request, NASA allocated money to hire an additional 2,000 workers over two years, a net gain of 550 after attrition. But this was inadequate compared to the decade of damage that had been done.

Decision by 'Bean Counters'

Despite the demand by NASA to turn around the years of neglect, by increasing investments in Shuttle upgrades, funding pressure from increased space station costs, within a flat total budget, were putting safety upgrades in jeopardy. In testimony before the Senate Subcommittee on Science, Technology, and Space on Sept. 6, 2001, Richard Blomberg, Chair of the Aerospace Safety Advisory Panel, stated that "little effort was being expended on the long-term safe use of the [Shuttle] system."

Blomberg warned that "improvements to the orbiter and the other Space Shuttle elements are being delayed in order to accommodate current budget needs." The situation becomes worse each year, he said, and if restoration of basic infrastructure continues to be delayed, "it will reach a point at which it may be impossible to catch up. Safety is an intangible whose true value is only appreciated in its absence," Blomberg counseled.

At the same hearing, the Chief Operating Officer of United Space Alliance—the industry consortium responsible for flight planning, astronaut training, and preparation of hardware and software for launch, employing 10,000 people in Texas and Florida—

also testified. Mike McCulley, a former astronaut with 17 years of experience in the Space Shuttle program, told the Senators that in his opinion, the "drive toward efficiency has moved us below sufficient funding for the many years of Shuttle operation ahead of us. . . . One half of annual maintenance budgets are spent band-aiding systems that are failing and then maintaining the band-aids."

Sen. Bill Nelson (D.-Fla.), who flew on the Shuttle Columbia in the flight just before the Challenger accident, had requested the hearing, to evaluate the impact of the \$500 million shortfall in Shuttle funding. The budget, Nelson said, "fails to adequately protect these astronauts." Safety upgrades that NASA considers critical "are now discretionary projects subject to available funding. All but one of the Shuttle's pending safety upgrades have been targeted for cancellation or deferral," Nelson reported. "Decisions about NASA priorities are coming not from NASA, but from bean counters at the President's budget office," Nelson said. "We've got accountants making life and death decisions for our astronauts. . . . We're starving NASA's Shuttle budget, and thus greatly increasing the chance of a catastrophic loss."

Just nine months ago, after the Aerospace Safety Advisory Panel's 2002 annual report was released, Blomberg stated before Congress, again, that "the Panel believes that safety has not yet been compromised," but that the report contains "the strongest safety concern the Panel has voiced in the 15 years I was involved with it." As the Shuttle ages, he warned, "the well-established characterization of the system is no longer fully valid." Blomberg also warned that "any plan to transition from the current

operational posture to one involving significant privatization would inherently involve an upheaval, with increased risk in its wake."

Longer term, more expensive fundamental changes to the Space Shuttle design—such as liquid fly-back boosters, to eliminate the more dangerous solid-fueled boosters, or increased on-orbit crew rescue capabilities—were never seriously even begun.

The 'Shareholder Value' Invasion

The Shuttle had barely finished its initial test flights in the early 1980s, when President Ronald Reagan and his budget balancers ordered NASA to try to find a buyer for the orbiter fleet. The idea was that privatizing the Shuttle would decrease the amount of Federal funds for the program, cut costs, and enable it to run "like a railroad." No company was foolish enough to take the bait, however, despite the rhetoric.

But as Space Shuttle budgets were declining in the early 1990s, NASA man-

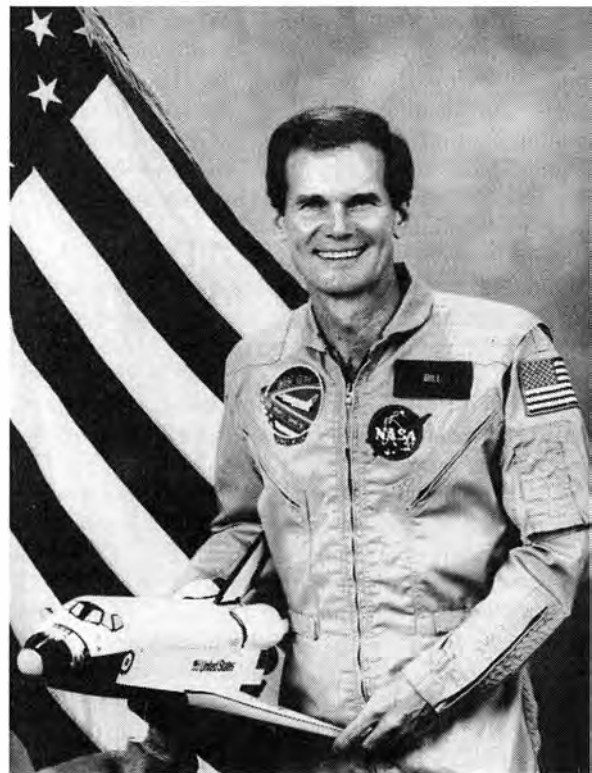

NASA

Sen. Bill Nelson at congressional hearings Sept. 6, 2001: "We've got accountants making life and death decisions for our astronauts. . . . We're starving NASA's Shuttle budget, and thus greatly increasing the chance of a catastrophic loss." Here, Nelson's official photo before his 1985 Shuttle flight.

agers worried about flying the Shuttle safely with less money. NASA Administrator Goldin dismissed their concerns. "When I ask for the budget to be cut," he told a meeting of NASA employees in September 1994, "I'm told it's going to impact safety on the Space Shuttle and it'll destroy reliability on these other [unmanned] flights. I think that's a bunch of crap."

Three months later, astronaut Robert Crippen—the pilot of the first Shuttle flight in 1981—abruptly announced his decision to resign as director of the Kennedy Space Center, saying it was prompted in part by concern about continuing budget cuts.

In November 1994, NASA announced that an independent team, led by former Johnson Space Center Director Chris Kraft, would review "innovative concepts," and new "management options" for dealing with the continuing budget cuts in the Shuttle program. The report, released in March the next year, included the recommen-

dation that NASA consolidate its 20 Shuttle prime subcontractors and 59 major subcontractors, as a "stepping-stone" to the full privatization of the Shuttle.

The report contended that the program, to "meet the challenge of reducing costs," should do away with "expensive habits." "Safety is one of those terms that can be used to hide behind and prevent necessary change and innovation," the report claimed. It complained that "ground testing is routinely performed on much of the hardware, even if it performed flawlessly on its previous mission."

The report's call for commercializing the fleet was immediately embraced by the Administration, in the person of Dan Goldin; and by the Congress, led by House Science Committee Chairman Robert Walker (R.-Pa.). But many were alarmed. John Pike, then of the Federation of American Scientists, called the Kraft report "close to hallucinatory,"



NASA

When President Kennedy proposed the Apollo Program in May 1961, he warned Congress that if they were not prepared to spend the necessary money, the program should not even be attempted. Kennedy instituted an investment tax credit and other fiscal measures, to vector private-sector resources toward high-technology R&D and manufacturing investments that would support the exploration of space. Here, President Kennedy makes his historic message to Congress, on May 25, 1961, calling for landing a man on the Moon within the decade.

and described changes in the philosophy on safety procedures as foolhardy and dangerous. He predicted that the recommendations would one day be considered "the turning point that led to the next Shuttle accident." The Aerospace Safety Advisory Panel warned that such a radical restructuring of the program was having a serious impact on safety.

The impact of the growing budget cuts was already leading NASA managers to propose drastic manpower cuts. In order to meet the projected \$5 billion cut in Shuttle funding over the coming five years, NASA said in 1995 that no further upgrades would be initiated. Over five years, the workforce at the Marshall Space Flight Center, which clears the Shuttle's main engines for flight, would be reduced from 220 to 50. Those involved in clearing the External Tank for launch would go from 134 to 23, while those working on certifying the solid rocket boosters would drop from

126 to 26.

Failure Waiting to Be Discovered

At the Kennedy Space Center, civil service workers who do engineering and development of the orbiter would decline from 395 to 184 by 1999. Those in launch processing and safety would be cut from 880 to 450 by the turn of the century. NASA oversight of contractor work would be cut significantly. The NASA director of Space Shuttle operations, astronaut Brewster Shaw, said this would mean abandoning NASA's guiding assumption about Shuttle safety: that "you've got a generic failure waiting to be discovered."

Administrator Goldin vowed to reduce the manpower deployed in Shuttle safety operations, in line with the Kraft panel's privatization recommendations. "We had 183 people signing off on flight readiness for the Shuttle," Goldin said in June 1995. "To me, that represents a threat" to safety, rather than a guarantee of it. In contrast, NASA's

most experienced astronaut, John Young, told Associated Press, "you can't reduce people without introducing a lot of risk, because you just work people too hard."

Much of the work that had been done by civil service employees was to be contracted out to the industry management entity, United Space Alliance, a joint venture of Lockheed Martin and Rockwell International (which built the orbiters, and was later taken over by Boeing). This shift of Shuttle operations to management by the private sector was sold to nonbelievers as the only way to cut costs and still fly.

United Space Alliance signed a \$7 billion contract with NASA at the end of September 1996. One month earlier, Kennedy Center director Jay Honeycutt, who had taken over when Bob Crippen resigned, warned that the hundreds of layoffs planned for the launch center would leave many jobs undone, including safety inspections. In October, Honeycutt, who had worked for NASA since 1960, announced that he was retiring.

The level of Shuttle funding continues to be determined by the White House and Congress, and with NASA approval, United Space Alliance makes the decisions as to where and which of its contract employees will be eliminated when budgets are cut. And although United Space Alliance brought in astronauts to manage its operations at both the Kennedy and Johnson Space Centers, the company is in business to make money. It insists that safety, which is the criterion used to determine incentive payments in its NASA contract, will always come first, but there is little doubt that downgraded NASA oversight has had an impact on safety.

By 1997, United Space Alliance was pushing for increased commercializa-

tion, as a way for it to make more money from its Shuttle operations. Johnson Space Center Shuttle manager Tommy Holloway summed up NASA's negotiations with United Space Alliance on the proposed changes, stating, "We have different objectives." United Space Alliance's objective "is to fly the program and make money. Our objective is to reduce costs, but we don't worry so much about them making money."

At the same time, the Aerospace Safety Advisory Panel, testifying before Congress on March 13, 1997, warned that even though it could find no additional safety risk arising from the contract with United Space Alliance, it noted "that the rewards and penalties of the incentive [contract] may motivate the contractor to actions which are unanticipated by either party today, and which may pose additional

risks to safe operations in the future." This increased potential risk was introduced for no other reason than to cut costs.

Four years after United Space Alliance began managing much of the Shuttle program, a March 2000 report by an independent safety analysis team stated that there was too little government oversight of contractors working on the Shuttle. The team said it was troubled by increased risk resulting from a desire by the contractors to cut corners and costs to meet the schedule, which provides bonuses for the company. All new hires at the Kennedy Space Center, it advised, should be NASA employees, because NASA needs more hands-on involvement in maintenance and safety.

Mission, Not 'Profit'

There is no place in manned space programs for the "profit motive." The very nature of the effort means that it is impossible to know far in advance how much anything will cost. The level of funding support for the program must be determined by the mission to be accomplished, not the other way around. The space program has always depended upon private industry for the development of new technologies, manufacturing, and development of the payloads that use the space transportation system. But the infrastructure must be provided by the nation as a whole, for the benefit of all, as President Kennedy eloquently argued in 1961.

Technology-proud corporations have long ago become more wedded to their "bottom line" and dividends to stockholders, and controlled by Wall Street financiers rather than engineers. They should not be entrusted with management of the nation's space program.

Where Do We Go From Here?

When the Bush Administration came into office, Dan Goldin finally left. But



The seven astronauts of the Shuttle STS 107 flight, on their way to lift-off, January 16, 2003.

in came Sean O'Keefe, fresh from the Office of Management and Budget. A political protégé of Vice President Dick Cheney, O'Keefe was Comptroller of the Department of Defense under Cheney in the first Bush Administration. While still at OMB, O'Keefe told Congress that he would not support an increase in NASA funding, because "technical excellence

at any cost is not an acceptable approach." But at least, O'Keefe admitted he knew nothing about NASA, or the space program. To his credit, the new Administrator has brought some of the agency's most experienced astronauts into NASA management positions.

At his confirmation hearing in the Senate, O'Keefe admitted that he had no vision for NASA, and said that his plan for the space agency was to "get back to basics, reinvigorate the entrepreneurial spirit there, and "infuse prudent management." He sounded more like the bankruptcy judge in the

"We will 'fix' the space program when we have an economic policy that discards 'shareholder value' and the 'bottom line,' and returns to national investment in great projects that uplift the population morally, physically, and intellectually."

Enron case than the leader of NASA. This did not sit well with many of the Senators.

"The leader of NASA cannot just be a budget cutter," Sen. Kay Bailey Hutchinson (R.-Tex.) stated at the hearing on Dec. 7, 2001. "I don't think you can precisely budget a war, and I don't think you can precisely budget innovative research." In this kind of work, she said, "you are going to have mistakes, and miscalculations. You're going to learn from those. . . . NASA is one of the economic engines of America," she stated.

Disregarding Senator Hutchinson's

advice, the first policy decision made by the new administration, in July 2001, was to propose a reduction in the Space Shuttle program's funding by about \$1 billion from 2003 to 2007. This was designed to make up for the cost overruns in the space station program. A second decision was to emasculate the International Space Station, by refusing to increase

NASA's budget to provide the funds needed to complete the space laboratory.

Last year, under White House orders, O'Keefe commissioned the systems-analysis Rand Corporation to look into options for introducing more "competitiveness" into the Shuttle program. This was guided by the Bush principle that "government should be market-based"—the current version of Al Gore's "reinventing government." The September 2002 report called for more competition among suppliers, and for eventually selling the fleet of orbiters to the highest bidder. Money for things like

Books Received

Lords of the Harvest Biotech, Big Money, and the Future of Food, by Daniel Charles. Cambridge, Mass.: Perseus Publishing, 2003. Paperback, 348 pp., \$17.50.

An End to Global Warming, by Laurence O. Williams. Amsterdam: Pergamon, Elsevier Science, 2002. Hardcover, 209 pp., \$78.00.

Watson and DNA: Making a Scientific Revolution, by Victor K. McElheny. Cambridge, Mass.: Perseus Publishing, 2003. Hardcover, 365 pp., \$27.50.

Faster Than the Speed of Light: The Story of a Scientific Speculation, by Joao Magueijo. Cambridge, Mass.: Perseus Publishing, 2003. Hardcover, 279 pp., \$26.00.

Coal: A Human History, by Barbara Freese. Cambridge, Mass.: Perseus Publishing, 2003. Paperback, 308 pp., \$25.00.

The Ideas of Biology, by John Tyler Bonner. Mineola, N.Y.: Dover Publications, 2002 [1962]. Paperback, 180 pp., \$10.95.

Shoemaker by Levy: The Man Who Made an Impact, by David H. Levy. Princeton, N.J.: Princeton University Press, 2003. Paperback, 303 pp., \$16.95.

Aquagenesis: The Origin and Evolution of Life in the Sea, by Richard Ellis. New York: Penguin Books, 2002. Paperback, 292 pp., \$15.00.

The Man Who Flattened the Earth: Maupertuis and the Sciences in the Enlightenment, by Mary Terrall. Chicago: The University of Chicago Press, 2003. Hardcover, 408 pp., \$39.00.

A Sophisticate's Primer of Relativity (second ed.), by P.W. Bridgman. Mineola, N.Y.: Dover Publications, 2002. Paperback, 172 pp., \$12.95.

Einstein's Legacy, by Julian Schwinger. Mineola, N.Y.: Dover Publications, 2002 (reprint from 1986). Paperback, 250 pp., \$16.95.

In the Blink of an Eye, by Andrew Parker. Cambridge, Mass.: Perseus Publishing, 2003. Hardcover, 299 pp., \$27.50.

The Tests of Time: Readings in the Development of Physical Theory, Lisa M. Dolling, Arthur F. Gianelli, Glenn N. Statile, eds. Princeton, N.J.: Princeton University Press, 2003. Paperback, 716 pp., \$36.95.

The Abyss of Time: Changing Conceptions of the Earth's Antiquity After the Sixteenth Century, by Claude C. Albritton, Jr. Mineola, N.Y.: Dover Publications, 2002 (reprint from 1980). Paperback, 251 pp., \$14.95.

Secret Agents: The Menace of Emerging Infections, by Madeline Drexler. New York: Penguin Books, 2003. Paperback, 319 pp., \$15.00.

Life Decoded: The Sun, Your Origin, and the Creation of Life in the Universe, by Marek J. Lassota. Chicago: Ascent Books, LLC, 2002. Hardcover, 432 pp., \$37.00.

The Man Who Found Time: James Hutton and the Discovery of the Earth's Antiquity, by Jack Repcheck. Cambridge, Mass.: Perseus Books, 2003. Paperback, 229 pp., \$26.00.

Sputnik: The Shock of the Century, by Paul Dickson. New York: Berkeley Publishing Group, 2003. Paperback, 310 pp., \$13.95.

International Space Station, by Bruce LaFontaine. Mineola, N.Y.: Dover Publications Inc. Paperback (Dover Coloring Book), 2003.

The Search for the Ultimate Space: The Space Mass Theory, by R.A. Bowland. Philadelphia: Xlibris Corporation, 2001. Paperback, 183 pp., \$21.99.

How to Build a Time Machine, by Paul Davies. New York: Penguin Books, 2001. Paperback, 132 pp., \$12.00.

Pandora's Keepers: Nine Men and the Atomic Bomb, by Brian VanDeMark. New York: Little, Brown and Company, 2003. Hardcover, 381 pp., \$26.95

Rocket Dreams: How the Space Age Shaped Our Vision of a World Beyond, by Marina Benjamin. New York: The Free Press, 2003. Hardcover, 243 pp., \$24.00.

safety upgrades would be raised from private capital.

The Rand report pointed out that about 92 percent of NASA's \$3.2 billion per year Shuttle funding already goes to private contractors, but the report called for more. The reaction to the report by Kennedy Space Center Director Roy Bridges, a former astronaut and retired Major General, was that some commercial concepts could end up "with a Shuttle being flown into the water." Sen. Bill Nelson compared the proposal to the Pentagon handing over its forces to a private company to fight a war.

The Mission of NASA

The idea that the Space Shuttle program must be more "cost effective"; that accountants in the budget office should decide what the nation can afford to spend on space exploration; that these expenditures "take money from" other projects, imposing limits on NASA funding; that bringing in the private sector and the profit motive to this research and development endeavor will make things cheaper—all these are false and dangerous assumptions that have brought us to where we are today.

NASA should be a "brain trust" for the nation. Its laboratories, in collaboration with universities and other research institutions, should lead inquiries into the most vital issues of science—in astronomy and macro-physics, the life sciences, and micro-physics. Each NASA Center should be the nucleus of a "science city," where the frontiers of research are the focus. Like the Moon-Mars vision, science itself, including the best of academia, has been destroyed in the past decades, and needs to be rebuilt as badly as does the space program.

Space exploration has already posed many fundamental questions. Astronomers have found evidence of solar systems around other stars, which are very different from our own. Where are today's Keplers, who will discover the universal principles that can explain these fascinating new worlds? The proposition that there was once life on Mars has led to the discovery that life can exist in the most extreme Earth environments, overturning long-held concepts of the "envelope" of require-

ments for life. How does the development of life on Mars challenge our fundamental hypotheses of life on our own planet? How can the exposure of life to the microgravity environment of space, or the partial gravity of other planetary bodies, open up new means of discovery?

In order to be able to answer such questions, the space agency is charged with creating the transportation and other infrastructure needed to carry out missions to expand human knowledge. As the science and exploration objectives drive the development of revolutionary new technologies, NASA should be creating and spinning out into the economy new energy and propulsion techniques, new materials, medical breakthroughs, and industrial processes, at a rate at least comparable to that of the Apollo program.

The advanced fission and nuclear fusion technologies that we must develop for manned missions to Mars will bring an era of unlimited energy to this planet. The technologies to create artificial biospheres in space and terraform Mars will bring forth ways to make Earth's deserts bloom. The life support techniques to care for crews off planet will revolutionize the way we nourish human health at home.

We would not have record-breaking unemployment, rotted out and abandoned industries, a transportation system that is disintegrating, a population that is addicted to drugs, television, and video games, or a systemic financial crisis, were economic policy organized to invest our resources in science, technology, and infrastructure—most profitably represented by our space program. We will "fix" the space program when we have an economic policy that discards "shareholder value" and the "bottom line," and returns to national investment in great projects that uplift the population morally, physically, and intellectually.

Now, with the Feb. 1 loss of Columbia, all of the cards have been thrown up into the air. There is a window of opportunity to cast away 30 years of refusing to have long-range visionary goals for space exploration, and marshal the resources required for this great project.

Letters

Continued from page 4

upheld and demonstrated to be factual by William Donald Kelley, DDS, through practical experience and thousands of cases. . . .

Curie insisted that X-ray was the proper approach to cancer and, of course, no one in their right mind, and acquainted with the facts would submit to that form of treatment. So, I don't share your enthusiastic zeal over Madame Curie. By the way, she died of cancer from radiation.

Daniel H. Duffy, Sr.
Geneva, Ohio

The Editor Replies:

In matters of science, it is better to stick to what we know, provably, even if it be far less than we would like to know. Most scientific error arises from attempting to claim more than can be justified by our knowledge. We do not believe that the cause of cancer is yet understood.

INFINITE ENERGY MAGAZINE

New Energy • New Science



Sample Copy of Current Issue

\$5.95 North America/\$10.00 Foreign

Subscription (6 Issues)

\$29.95 North America/\$49.95 Foreign

Contact us for our catalog of books, videos and other products, or visit our website.

New Energy Foundation, Inc.

P.O. Box 2816-TF

Concord, NH 03302-2816

Phone: 603-228-4516 • Fax: 603-224-5975

<http://www.infinite-energy.com>

2002 INDEX

21st CENTURY SCIENCE & TECHNOLOGY

Volume 15

AUTHOR INDEX

- Allais, Maurice. "On a Connection between Electromagnetism and Gravitation: The Action of a Magnetic Field on the Motion of a Pendulum." Summer, 34.
- Anfimov, Dr. Nikolai A. "Interview with Academician Nikolai Anfimov: Inside Russia's Unique Space Science Institute." (Marsha Freeman) Spring, 78.
- Assis, André Koch Torres, Karin Reich, and Karl Heinrich Wiederkehr. "Gauss and Weber's Creation of the Absolute System of Units in Physics." Fall, 40.
- Cherry, David. "An Opening in Astronomy." Fall, 49.
- Cilli, Giovanni, and Caroline Hartmann. "Interview with Dr. Giancarlo Costa: Out-of-Soil Farming Produces a Superior Product at Less Cost." (tr. by Elisabeth Pascali) Spring, 76.
- Conlon, Joseph M. "Mosquito Spraying Essential to Keep America Healthy." Fall, 12.
- Costa, Dr. Giancarlo. "Interview with Dr. Giancarlo Costa: Out-of-Soil Farming Produces a Superior Product at Less Cost." (Giovanni Cilli and Caroline Hartmann, tr. by Elisabeth Pascali) Spring, 76.
- De Paoli, Dino. "Leonardo da Vinci's Geology and the Simultaneity of Time." Summer, 17.
- Dean, Dr. Stephen O. "Practical Fusion Power Is a Question of Political Will." Summer, 59.
- Director, Bruce. "Gauss's Declaration of Independence: The Fundamental Theorem of Algebra." Spring, 66.
- Chang-Kun Lee, Dr. "A Nuclear Perspective from Asia." Winter, 70.
- Edwards, Dr. J. Gordon, Ph.D. "Mosquitoes, DDT, and Human Health." Fall, 16.
- Edwards, Dr. J. Gordon, Ph.D. "[Malaria] Vaccine Research: Many Leads, But Little Success." Fall, 28.
- Freeman, Marsha. "Ibero-America Needs a Space Agency!" Spring, 31.
- Freeman, Marsha. "Von Braun: Why Argentina Should Be in Space." Spring, 33.
- Freeman, Marsha. "Interview with Academician Nikolai Anfimov: Inside Russia's Unique Space Science Institute." Spring, 78.
- Freeman, Marsha. "100th Extrasolar Planet Candidate Found." Summer, 50.
- Freeman, Marsha. "Surrey's Nano-Satellites: Bringing Developing Nations Into the Space Age." Summer, 55.
- Freeman, Marsha. "Report on the 2002 World Space Congress: Economic Collapse Threatens Prospects for Space Exploration." Fall, 50.
- Grenier, Emmanuel. "When Light Governs the Expression of Genes." Summer, 9.
- Ham, Denise. "Marie Skłodowska Curie: The Woman Who Opened The Nuclear Age." Winter, 30.
- Ham, Denise. "Re-creating the Curie Experiment to Measure Radioactivity." Winter, 39.
- Ham, Denise. "Dr. Robert Abbe: U.S. Champion of the Curies." Winter, 51.
- Ham, Denise. "Marie Curie and Einstein." Winter, 58.
- Ham, Denise. "The Promise of Nuclear Power As Seen from 1967." Winter, 64.
- Hartman, Caroline, and Elisabeth Pascali. "Growing Food in Air: A Second-Generation Green Revolution." Spring, 75.
- Hartmann, Caroline, and Giovanni Cilli. "Interview with Dr. Giancarlo Costa: Out-of-Soil Farming Produces a Superior Product at Less Cost." (tr. by Elisabeth Pascali) Spring, 76.
- Hecht, Laurence. "Teach Gauss's 1799 Proof of the Fundamental Theorem of Algebra." (editorial) Spring, 2.
- Hecht, Laurence. "Have [Edwin] Hall's Questions Been Answered?" Summer, 60.
- Hecht, Laurence. "Reverend Moon and the 'Unity of Sciences' Cult." (editorial) Fall, 2.
- Hecht, Laurence. "The Method of Language Discovery: The Concept of Indo-European Philology." Fall, 38.
- Hecht, Laurence. "In Memoriam: Colonel Ray Vinson, Inventor of Magnettrain, and Julia Vinson." Fall, 9.
- Hecht, Laurence. "Science and the New Silk Road." (editorial) Winter, 2.
- Hecht, Laurence. "Moonification of the Sciences: The Russell-Wells 'No-Soul' Gang Behind the Moonie Freak Show." Winter, 6.
- Hecht, Marjorie Mazel. "Interview with Walter Simon: General Atomics Reactor in Russia to Burn Weapons Plutonium." Spring, 70.
- Hecht, Marjorie Mazel. "South Africa's PBMR Is Moving Ahead." Spring, 74.
- Hecht, Marjorie Mazel. "Bring Back DDT, and Science With It!" (editorial) Summer, 2.
- Ivanova, Dr. Tania. "Space Farming on Mars: Greenhouse Abord Mir Shows Plants Can Thrive in Space." Summer, 41.
- Ivanova, Dr. Tania. "The Proposed SVET-3 Greenhouse for ISS." Summer, 46.
- Jaworowski, Dr. Zbigniew. "An Open Letter For Support of UNSCEAR." Summer, 53.
- LaRouche, Lyndon H., Jr. "LaRouche Tells Video Gamer How to Break the Habit." Summer, 12.
- LaRouche, Lyndon H., Jr. "Schizophrenic-Like Video-Game Disorder." Summer, 12.
- LaRouche, Lyndon H., Jr. "LaRouche on War and Video Games." Summer, 12.
- Leonardo da Vinci. "Leonardo da Vinci's Geology and the Simultaneity of Time." (Dino De Paoli) Summer, 17.
- Maitra, Ramtanu. "9,000-Year-Old Citites Beneath The Gulf of Cambay?" Fall, 35.
- Mendell, Dr. Wendell W. "Back to the Moon, Then On to Mars!" Spring, 10.
- Moser, Sieghart. "A View of Geodynamics." Summer, 8.
- Pascali, Elisabeth, and Caroline Hartmann. "Growing Food in Air: A Second-Generation Green Revolution." Spring, 75.
- Reich, Karin, André Koch Torres Assis, and Karl Heinrich Wiederkehr. "Gauss and Weber's Creation of the Absolute System of Units in Physics." Fall, 40.
- Roberts, Dr. Donald R., Ph.D. "To Control Malaria, We Need DDT!" (adapted from "DDT and Malaria Control: Past, Present, and Future," by Dr. Roberts) Fall, 33.
- Rush, Timothy. "Alexander von Humboldt: A Republican Scientist in the Tradition of Franklin." Spring, 12.
- Rush, Timothy. "'Unity and Harmony': Humboldt's View of Nature." Spring, 14.
- Rush, Timothy. "Humboldt and the Mendelssohn Family." Spring, 16.
- Rush, Timothy. "Humboldt's Travels in South and Central America." Spring, 20.
- Sanders, Rick. "In Memoriam: Thor Heyerdahl (1914-2002): A 20th Century Pioneer of Ancient Navigation." Summer, 15.
- Schauerhammer, Ralf. "Why There Really Are No Limits to Growth." Spring, 58.
- Simon, Walter. "Interview with Walter Simon: General Atomics Reactor in Russia to Burn Weapons Plutonium." (Marjorie Mazel Hecht) Spring, 70.
- Stevens, Charles B. "PPPL Celebrates 50 Years of Fusion Research: Putting Fusion Back on the Front Burner." Summer, 58.
- Vereycken, Karel. "The Camera Obscura or Dark Room." Fall, 59.
- Wiederkehr, Karl Heinrich, André Koch Torres Assis, and Karin Reich. "Gauss and Weber's Creation of the Absolute System of Units in Physics." Fall, 40.

SUBJECT INDEX

Agriculture

- Hartmann, Caroline, and Elisabeth Pascali. "Growing Food in Air: A Second-Generation Green Revolution." Spring, 75.
- Pascali, Elisabeth, and Caroline Hartmann. "Growing Food in Air: A Second-Generation Green Revolution." Spring, 75.
- Costa, Dr. Giancarlo. "Interview with Dr. Giancarlo Costa: Out-of-Soil Farming Produces a Superior Product at Less Cost." (Giovanni Cilli and Caroline Hartmann, tr. by Elisabeth Pascali) Spring, 76.
- Cilli, Giovanni, and Caroline Hartmann. "Interview with Dr. Giancarlo Costa: Out-of-Soil Farming Produces a Superior Product at Less Cost." (tr. by Elisabeth Pascali) Spring, 76.
- Hartmann, Caroline, and Giovanni Cilli. "Interview with Dr. Giancarlo Costa: Out-of-Soil Farming Produces a Superior Product at Less Cost." (tr. by Elisabeth Pascali) Spring, 76.
- Hecht, Marjorie Mazel. "Bring Back DDT, and Science With It!" Summer, 2.
- Ivanova, Dr. Tania. "Space Farming on Mars: Greenhouse Abord Mir Shows Plants Can Thrive in Space." Summer, 41.
- Ivanova, Dr. Tania. "The Proposed SVET-3 Greenhouse for ISS." Summer, 46.
- News Brief. "Egypt's Toshka Mega-Project Set to Make the Desert Bloom." Winter, 5.

Ancient Discovery

- News Brief. "15,000 Year Old Portraits Found in French Cave." Summer, 10.
- News Brief. "Ice Age Bison Carving Found Near Moscow." Summer, 11.
- Sanders, Rick. "In Memoriam: Thor Heyerdahl (1914-2002): A 20th Century Pioneer of Ancient Navigation." Summer, 15.
- Maitra, Ramtanu. "9,000-Year-Old Cities Beneath The Gulf of Cambay?" Fall, 35.
- Hecht, Laurence. "The Method of Language Discovery: The Concept of Indo-European Philology." Fall, 38.

Astronomy and Astrophysics

- News Brief. "Saturn Lunar Occultations Provide Spectacular Images." Spring, 9.
- Allais, Maurice. "On a Connection between Electromagnetism and Gravitation: The Action of a Magnetic Field on the Motion of a Pendulum." Summer, 34.
- Freeman, Marsha. "100th Extrasolar Planet Candidate Found." Summer, 50.
- Cherry, David. "An Opening in Astronomy." Fall, 49.

Biography and Obituary

- Rush, Timothy. "Alexander von Humboldt: A Republican Scientist in the Tradition of Franklin." Spring, 12.
- Rush, Timothy. " 'Unity and Harmony': Humboldt's View of Nature." Spring, 14.
- Rush, Timothy. "Humboldt and the Mendelssohn Family." Spring, 16.
- Rush, Timothy. "Humboldt's Travels in South and Central America." Spring, 20.
- News Brief. "French Nuclear Pioneer, Bertrand Goldschmidt, Dead at 89." Summer, 10.
- Sanders, Rick. "In Memoriam: Thor Heyerdahl (1914-2002): A 20th Century Pioneer of Ancient Navigation." Summer, 15.

- De Paoli, Dino. "Leonardo da Vinci's Geology and the Simultaneity of Time." Summer, 17.
- Hecht, Laurence. "In Memoriam: Colonel Ray Vinson, Inventor of Magnettrain, and Julia Vinson." Fall, 9.
- News Brief. "In Memoriam: Peter A. Toynbee (1923-2002)." Winter, 5.
- Ham, Denise. "Marie Sklodowska Curie: The Woman Who Opened The Nuclear Age." Winter, 30.
- Ham, Denise. "Dr. Robert Abbe: U.S. Champion of the Curies." Winter, 51.
- Ham, Denise. "Marie Curie and Einstein." Winter, 58.

Biology

- Grenier, Emmanuel. "When Light Governs the Expression of Genes." Summer, 9.
- Ivanova, Dr. Tania. "Space Farming on Mars: Greenhouse Abord Mir Shows Plants Can Thrive in Space." Summer, 41.
- Ivanova, Dr. Tania. "The Proposed SVET-3 Greenhouse for ISS." Summer, 46.

Development and Population Policy

- Freeman, Marsha. "Ibero-America Needs a Space Agency!" Spring, 31.
- Schauerhammer, Ralf. "Why There Really Are No Limits to Growth." Spring, 58.
- Hecht, Marjorie Mazel. "Bring Back DDT, and Science With It!" Summer, 2.
- News Brief. "Now They're Afraid of Children. . . ." Fall, 11.
- News Brief. "LaRouche Calls for 'Super TVA' Infrastructure Project." Fall, 11.
- Hecht, Laurence. "Science and the New Silk Road." Winter, 2.
- News Brief. "World's First Commercial Maglev Train Takes Off in Shanghai!" Winter, 4.
- News Brief. "Egypt's Toshka Mega-Project Set to Make the Desert Bloom." Winter, 5.
- News Brief. "Too Many 'Bare Sticks' Lead to War, Says *Population Press*." Winter, 5.

Earth Science

- Moser, Sieghart. "A View of Geodynamics." Summer, 8.
- News Brief. "Nuclear Chemist Says Earth's Core is a Fast Breeder Reactor." Summer, 10.
- News Brief. "Experiment Shows Gravitational Constant Varies with Direction." Summer, 11.
- De Paoli, Dino. "Leonardo da Vinci's Geology and the Simultaneity of Time." Summer, 17.
- Allais, Maurice. "On a Connection between Electromagnetism and Gravitation: The Action of a Magnetic Field on the Motion of a Pendulum." Summer, 34.

Environment and Environmentalism

- News Brief. "Danish Government Cancels Wind Farms As Too Costly." Spring, 9.
- News Brief. "Complaint Filed Against PETA with Internal Revenue Service." Spring, 9.
- Hecht, Marjorie Mazel. "Bring Back DDT, and Science With It!" (editorial) Summer, 2.
- News Brief. "*New York Times* Caught Hying Alaska Warming Data." Summer, 11.
- News Brief. "WWF Loses Suit Against LaRouche Associates in Brazil." Fall, 10.
- Edwards, Dr. J. Gordon, Ph.D. "Mosquitoes, DDT, and Human Health." Fall, 16.
- News Brief. "*21st Century's* 'Bring Back DDT' Campaign Makes News." Winter, 4.

Epistemology

- News Brief. "15,000 Year Old Portraits Found in French Cave." Summer, 10.
- News Brief. "Ice Age Bison Carving Found Near Moscow." Summer, 11.
- LaRouche, Lyndon H., Jr. "Schizophrenic-Like Video-Game Disorder." Summer, 12.
- LaRouche, Lyndon H., Jr. "LaRouche on War and Video Games." Summer, 12.
- LaRouche, Lyndon H., Jr. "LaRouche Tells Video Gamer How to Break the Habit." Summer, 12.
- Hecht, Laurence. "The Method of Language Discovery: The Concept of Indo-European Philology." Fall, 38.

Geometry and Mathematics

- Hecht, Laurence. "Teach Gauss's 1799 Proof of the Fundamental Theorem of Algebra." Spring, 2.
- Director, Bruce. "Gauss's Declaration of Independence: The Fundamental Theorem of Algebra." Spring, 66.

History of Science and Technology

- Rush, Timothy. "Alexander von Humboldt: A Republican Scientist in the Tradition of Franklin." Spring, 12.
- Rush, Timothy. " 'Unity and Harmony': Humboldt's View of Nature." Spring, 14.
- Rush, Timothy. "Humboldt and the Mendelssohn Family." Spring, 16.
- Rush, Timothy. "Humboldt's Travels in South and Central America." Spring, 20.
- Freeman, Marsha. "Ibero-America Needs a Space Agency!" Spring, 31.
- Freeman, Marsha. "Von Braun: Why Argentina Should Be in Space." Spring, 33.
- News Brief. "Alexandria Library Rebuilt, After 1,600 Years." Fall, 10.
- Maitra, Ramtanu. "9,000-Year-Old Cities Beneath The Gulf of Cambay?" Fall, 35.
- Hecht, Laurence. "Moonification of the Sciences: The Russell-Wells 'No-Soul' Gang Behind the Moonie Freak Show." Winter, 6.
- Ham, Denise. "Marie Sklodowska Curie: The Woman Who Opened The Nuclear Age." Winter, 30.
- Ham, Denise. "Re-creating the Curie Experiment to Measure Radioactivity." Winter, 39.
- Ham, Denise. "Dr. Robert Abbe: U.S. Champion of the Curies." Winter, 51.
- Ham, Denise. "Marie Curie and Einstein." Winter, 58.
- Ham, Denise. "The Promise of Nuclear Power As Seen from 1967." Winter, 64.

Medicine

- News Brief. "OAU Launches New Campaign to Eradicate the TseTse Fly." Spring, 8.
- News Brief. "Kenyan Researcher Successful with Nutriton Treatment for AIDS." Spring, 9.
- News Brief. "Canadian Reactor to Produce Medical Isotopes." Fall, 10.
- News Brief. "African Anti-Malaria Organization Makes Case for DDT." Fall, 11.
- Conlon, Joseph M. "Mosquito Spraying Essential to Keep America Healthy." Fall, 12.
- Edwards, Dr. J. Gordon, Ph.D. "Mosquitoes, DDT, and Human Health." Fall, 16.
- Edwards, Dr. J. Gordon, Ph.D. "[Malaria] Vaccine Research: Many Leads, But Little Success." Fall, 28.
- Roberts, Dr. Donald R., Ph.D. "To Control Malaria, We Need DDT!" Fall, 33.

Military Technology

- LaRouche, Lyndon H., Jr. "Schizophrenic-Like Video-Game Disorder." Summer, 12.
- LaRouche, Lyndon H., Jr. "LaRouche on War and Video Games." Summer, 12.
- LaRouche, Lyndon H., Jr. "LaRouche Tells Video Gamer How to Break the Habit." Summer, 12.

Nuclear Science and Nuclear Energy

- News Brief. "Exelon Withdraws from Supplier End of Pebble Bed Reactor." Spring, 8.
- Freeman, Marsha. "Ibero-America Needs a Space Agency!" Spring, 31.
- Simon, Walter. "Interview with Walter Simon: General Atomics Reactor in Russia to Burn Weapons Plutonium." (Marjorie Mazel Hecht) Spring, 70.
- Hecht, Marjorie Mazel. "Interview with Walter Simon: General Atomics Reactor in Russia to Burn Weapons Plutonium." Spring, 70.

Back Issues of

21st CENTURY SCIENCE & TECHNOLOGY

are available at
\$5 each postpaid
(\$8 foreign).

Send check or money order
U.S. currency only

21st Century

P.O. Box 16285
Washington, D.C. 20041

Or order online at
www.21stcenturysciencetech.com

Index for 1988-2000 available on website

- Hecht, Marjorie Mazel. "South Africa's PBMR Is Moving Ahead." Spring, 74.
- News Brief. "Nuclear Chemist Says Earth's Core Is a Fast Breeder Reactor." Summer, 10.
- News Brief. "Brazil Begins Production of Its Own Enriched Uranium." Summer, 11.
- Jaworowski, Dr. Zbigniew. "An Open Letter for Support of UNSCEAR." Summer, 53.
- Stevens, Charles B. "PPPL Celebrates 50 Years of Fusion Research: Putting Fusion Back on the Front Burner." Summer, 58.
- Dean, Dr. Stephen O. "Practical Fusion Power Is a Question of Political Will." Summer, 59.
- News Brief. "Canadian Reactor to Produce Medical Isotopes." Fall, 10.
- News Brief. "Washington State Groups Sue DOE to Stop FFTF Shutdown." Fall, 10.
- News Brief. "Milestone for South Africa's Pebble Bed Nuclear Reactor." Winter, 5.
- Ham, Denise. "Marie Skłodowska Curie: The Woman Who Opened The Nuclear Age." Winter, 30.
- Ham, Denise. "Re-creating the Curie Experiment to Measure Radioactivity." Winter, 39.
- Ham, Denise. "The Promise of Nuclear Power As Seen from 1967." Winter, 64.
- Chang-Kun Lee, Dr. "A Nuclear Perspective from Asia." Winter, 70.

Pedagogy

- Hecht, Laurence. "Teach Gauss's 1799 Proof of the Fundamental Theorem of Algebra." (editorial) Spring, 2.
- Director, Bruce. "Gauss's Declaration of Independence: The Fundamental Theorem of Algebra." Spring, 66.
- Ham, Denise. "Re-creating the Curie Experiment to Measure Radioactivity." Winter, 39.

Physics

- News Brief. "Experiment Shows Gravitational Constant Varies with Direction." Summer, 11.
- Allais, Maurice. "On a Connection between Electromagnetism and Gravitation: The Action of a Magnetic Field on the Motion of a Pendulum." Summer, 34.
- Assis, André Koch Torres, Karin Reich, and Karl Heinrich Wiederkehr. "Gauss and Weber's Creation of the Absolute System of Units in Physics." Fall, 40.
- Hecht, Laurence. "Postscript: Have [Edwin] Hall's Questions Been Answered?" Summer, 60.

Science Policy

- Jaworowski, Dr. Zbigniew. "An Open Letter for Support of UNSCEAR." Summer, 53.
- Hecht, Laurence. "Reverend Moon and the 'Unity of Sciences' Cult." (editorial) Fall, 2.
- News Brief. "Alexandria Library Rebuilt, After 1,600 Years." Fall, 10.
- News Brief. "Washington State Groups Sue DOE to Stop FFTF Shutdown." Fall, 10.
- Conlon, Joseph M. "Mosquito Spraying Essential to Keep America Healthy." Fall, 12.
- Edwards, Dr. J. Gordon, Ph.D. "Mosquitoes, DDT, and Human Health." Fall, 16.
- Edwards, Dr. J. Gordon, Ph.D. "[Malaria] Vaccine Research: Many Leads, But Little Success." Fall, 28.
- Freeman, Marsha. "Report on the 2002 World Space Congress: Economic Collapse Threatens Prospects for Space Exploration." Fall, 50.
- Hecht, Laurence. "Science and the New Silk Road." (editorial) Winter, 2.
- Hecht, Laurence. "Moonification of the Sciences: The Russell-Wells 'No-Soul' Gang Behind the Moonie Freak Show." Winter, 6.
- Ham, Denise. "The Promise of Nuclear Power As Seen from 1967." Winter, 64.

Space Science, Technology, and Exploration

- News Brief. "Chinese Launch Third Shenzhou Test Spacecraft for Manned Flight." Spring, 8.
- Mendell, Dr. Wendell W. "Back to the Moon, Then On to Mars!" (Viewpoint) Spring, 10.
- Freeman, Marsha. "Ibero-America Needs a Space Agency!" Spring, 31.
- Freeman, Marsha. "Von Braun: Why Argentina Should Be in Space." Spring, 33.
- Anfimov, Dr. Nikolai A. "Interview with Academician Nikolai Anfimov: Inside Russia's Unique Space Science Institute." (Marsha Freeman) Spring, 78.
- Ivanova, Dr. Tania. "Space Farming on Mars: Greenhouse Abord Mir Shows Plants Can Thrive in Space." Summer, 41.
- Ivanova, Dr. Tania. "The Proposed SVET-3 Greenhouse for ISS." Summer, 46.
- Freeman, Marsha. "Surrey's Nano-Satellites: Bringing Developing Nations Into the Space Age." Summer, 55.
- News Brief. "China Launches Shenzhou IV, Prelude to Manned Space Flight." Winter, 4.

BOOK REVIEWS

- Duncan, Francis. *Rickover: The Struggle for Excellence* (Theodore Rockwell). Spring, 83.
- Miller, Ron and Frederick C. Durant III. *The Art of Chesley Bonestell* (Marsha Freeman). Spring, 85.
- Hoddeson, Lillian and Vicki Daitch. *True Genius: The Life and Science of John Bardeen* (Laurence Hecht). Summer, 60.
- Dewar, Elaine. *Bones: Discovering the First Americans* (David McVey). Summer, 62.
- Steel, Duncan. *Eclipse: The Celestial Phenomenon that Changed the Course of History* (Richard Sanders). Summer, 64.
- Hockney, David. *Secret Knowledge: Rediscovering the Lost Techniques of the Old Masters* (Karel Vereycken). Fall, 56.
- Dyson, George. *Project Orion* (Freeman, Marsha). Fall, 60.
- Capelotti, P.J. *Sea Drift: Rafting Adventures in the Wake of Kon-Tiki* (Richard Sanders). Fall, 64.
- Perlin, John. *From Space to Earth: The Story of Solar Electricity* (Howard C. Hayden). Winter, 69.

Richard Sanders
Over 15 Years Experience
Specializing in Scientific & Legal Translations
"I translate ideas, not just words!"
Translate from: German, Dutch, French, Italian & Spanish
Translate into: (U.S.) English
1-540-668-7141 Telephone
1-540-668-7142 Fax
Email: ricksanders@rcn.com

Is Astronomy a 'Body of Knowledge'?

by David Cherry

Astronomy Encyclopedia: An A-Z Guide To the Universe

Sir Patrick Moore, General Editor
New York: Oxford University Press, 2002
Hardcover, 456 pp., \$50.00

There are no good encyclopedias—at least, not yet—on astronomy or any other subject. But some have secondary merit, and *Astronomy Encyclopedia* is in that class.

A good encyclopedia must be organized in a manner consistent with the way in which knowledge itself actually develops. An article on cosmic rays—or anything else—would have to recapitulate the somewhat disorderly process by which our knowledge of the subject was achieved. It would have to go on to examine this presumed knowledge critically—for its inconsistencies and for weaknesses in its foundations—and then (if possible) report on research programs intended to address blank areas in our knowledge, or even aimed at entirely reconceptualizing the phenomenon. It could even propose such programs. The first such encyclopedia is yet to be written, but I hope to live long enough to see it.

Instead, our encyclopedias are characterized by presentation of the accepted story-of-the-moment on a given subject (no contradictions, doubts, or loose ends showing), as if a "Potemkin Village" version of current knowledge were not a form of lying, and as if the poor thing that passes for knowledge today should be given pride of place over the process of continuing discovery. Such works are lifeless.

Nevertheless, we are confronted with *Astronomy Encyclopedia* in this defective genre, and one cannot blame the individual work for the cultural defect that it expresses.

Astronomy Encyclopedia can be usefully compared to a work on the same subject of almost exactly the same scale, the *McGraw-Hill Encyclopedia of Astronomy* (2nd edition, 1993). A major difference between the two is that *Astronomy Encyclopedia* devotes con-

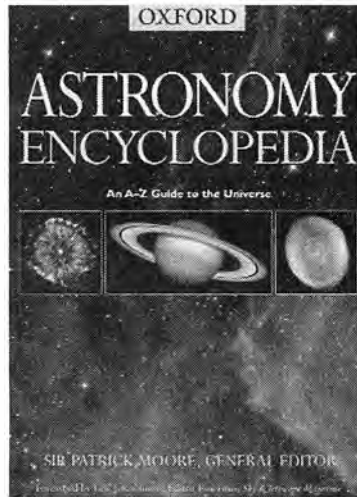

siderable space to biographical entries, while the McGraw-Hill encyclopedia devotes none. Even when individuals are named in the McGraw-Hill volume, these mentions are poor, sparse signposts to the history of discovery.

Because new conceptions are always the work of *individual minds*, intellectual biography (including the interplay of individual minds) must be the single most important ingredient in the elucidation of scientific knowledge. But there is a deliberate attempt in some works, such as the McGraw-Hill encyclopedia, to present science as an objective "body of knowledge," untouched by human hands, as it were.

What Kind of Biographies?

What, then, is the quality of the biographical entries in *Astronomy Encyclopedia*? The work's apparent advantage in having biographies, is nullified by falsification of their subjects! The article on Kepler, which is suitably lengthy, fails to identify him as the giant he was: Indeed, he was the father of modern astrophysics on the basis of his method. But then, the culture of science today discountenances his method.

The author opens with these words: "German astronomer and mathematician, remembered for his three laws of planetary

motion." The ensuing biography then places some emphasis on the "three laws." If the trajectory of Kepler's work were simply reduced to this, as it often is, it would amount in itself to an even worse falsification. But the article has the merit of consistently noting that "Kepler remained a lifelong believer in a divine plan for the cosmos," and of showing how this conviction that we live in a coherent cosmos, thanks to a loving God, shaped his work.

Further along, however, the author blunders badly in asserting about Kepler: "Having taken the important step of letting observations determine his planetary theories. . . ." But theories never emerge from data. The article itself provides evidence enough for that in Kepler's case. Kepler's all-important dialogue between thought and observation, spelled out in his works, is entirely missed.

The short biographies of Victor Ambartsumian and Halton Arp—two astronomers of our day who broke with some important, prevailing conceptions—are also crucially flawed. In the case of Ambartsumian, only those of his findings acceptable to Establishment astronomy are mentioned. There is no word of his remarkable conceptions—of his refusal to discuss "the universe" as misdefined by modern-day theorists, his counterposition of "white holes" (sources of energy) to the black holes of the usual misinterpretation of the Second Law of Thermodynamics, or his cautiousness about exporting the laws of terrestrial physics to other astrophysical environments.

In Arp's case, the author laudably devotes his limited space to one important aspect of Arp's creative, controversial thinking about the relationships among galaxies, galaxy clusters, active galactic nuclei (AGNs), and quasars. But then he concludes, "Arp proposed that AGNs, which often display very high redshifts, are ejected from the cores of nearby active galaxies with lower redshifts, *the higher apparent redshifts of the AGNs being the result of the violent ejection process.*"

Arp never proposed the idiotic idea found in the final phrase, noted here in italics. High-velocity ejection could only increase redshift if the AGNs were always ejected away from the observer! How could this character assassination be inadvertent? An honest, but ignorant, author would surely realize that no one could trigger as much hysteria in the astronomy Establishment as Arp has, with such a stupidity.

What Arp actually proposes is that matter is continually being created; that new mat-

ter emits at longer (more red) wavelengths and its emissions shift to shorter (higher frequency) wavelengths as the matter ages (as the elementary particles gain mass); and that AGNs are young matter produced in the cores of existing galaxies. (A virtually identical falsification is found in the *Encyclopedia Britannica* article on Arp.)

Arp's argument is falsified in a different way in the McGraw-Hill article on quasars (under "Distances of quasars"), where he is not mentioned by name.

The least one should expect, is that

our encyclopedias should highlight the unsolved problem that leads an Ambartsumian or an Arp to blaze a new trail. But the existing genre of encyclopedias scarcely admits of unsolved problems!

The poor performance exemplified by *Astronomy Encyclopedia*, demonstrated in detail here, can scarcely be avoided, once the prevailing genre is accepted. The secondary merit of the work is that it represents fairly well the accepted doctrine in astronomy. It is, after all, necessary to know what it is.

Shapes, But No Conceptions

by John Covici

Touch The Universe:
A NASA Braille Book of Astronomy
 by Noreen Grice
 Washington, D.C.: Joseph Henry Press, 2002
 Spiralbound, 59 pp., \$30.00

This book, a first by NASA for the blind, consists of a number of diagrams which are arranged so that someone who cannot see, can touch the shapes of various objects, such as the Hubble Space Telescope orbiting the Earth, a part of Jupiter's atmosphere, Saturn and its rings, and various other phenomena, including some nebulas and even distant galaxies—14 diagrams in all.

Before I review this book, please allow me to state a bit of background about myself.

I am visually impaired to the extent that I cannot see even light or dark, and have been so since birth some 57 years ago. For many years, I have been associated with Lyndon H. LaRouche, Jr., and have participated in classes discussing many subjects in which astronomers might be interested. These have included Kepler's discovery of the universal physical principle of gravitation, Gauss's discovery of the orbit of Ceres, and many others.

In these classes, the question arose as to how best to communicate the various physical constructions which were necessary to explain these conceptions to me.

When I say "communicate," I do not mean the transmission of some kind of "information," as though I were some sort of large computer, but language which would cause my own mind to reproduce the given conception. In the course of

these activities, we discovered that three-dimensional models were sometimes quite useful, but, particularly for very complicated figures, that it was better to describe the concepts in such a way that my own mind could reproduce them.

Shakespeare put this idea quite appropriately at the beginning of his play "Henry V":

"But pardon, and gentles all,
 The flat unraised spirits that have dared
 On this unworthy scaffold to bring forth
 So great an object: can this cockpit hold
 The vasty fields of France? or may we
 cram
 Within this wooden O the very casques
 That did affright the air at Agincourt?
 O, pardon! since a crooked figure may
 Attest in little place a million;
 And let us, ciphers to this great accompt,
 On your imaginary forces work.
 Suppose within the girdle of these walls
 Are now confined two mighty
 monarchies,
 Whose high upreared and abutting fronts
 The perilous narrow ocean parts asunder:
 Piece out our imperfections with your
 thoughts;
 Into a thousand parts divide on man,
 And make imaginary puissance;
 Think when we talk of horses, that you
 see them
 Printing their proud hoofs i' the
 receiving earth;
 For 'tis your thoughts that now must
 deck our kings,
 Carry them here and there; jumping
 o'er times,

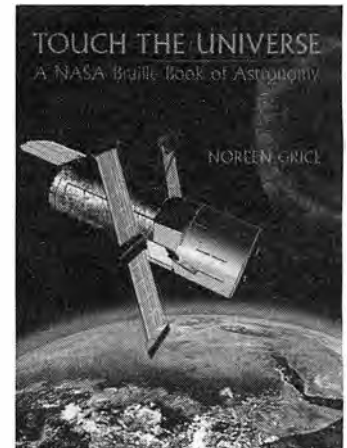

Turning the accomplishment of many years
 Into an hour-glass: for the which supply,
 Admit me Chorus to this history;
 Who prologue-like your humble
 patience pray,
 Gently to hear, kindly to judge, our play."

When I read this book, I was therefore disappointed. I had expected to find some insight which the shapes might give, into the phenomena described, but I found only some rather crowded diagrams, which did not communicate very much to me. The shapes were there, but no conceptions.

I would suggest to NASA and the author that a future direction for effort in works in braille, would be some of Kepler's discoveries (elliptical orbits, geometrical relationship of orbits, and so on). An even more ambitious effort might be Gauss's famous discovery of the orbit of Ceres, which conveys conceptually what Gauss did, and why other approaches did not succeed. (For this story, which I was able to grasp without braille diagrams, see "How Gauss Determined the Orbit of Ceres," by Jonathan Tennenbaum and Bruce Director, *Fidelio*, Summer 1998, pp. 4-88.

Have You Missed Any 21st Century? 21st CENTURY SCIENCE & TECHNOLOGY

Back issues are available at \$5 each (\$8 foreign) from our website or by mail. For a more detailed listing of contents, and a complete list of back issues available, check the magazine website: www.21stcenturysciencetech.com.

Spring 2002



- Alexander von Humboldt: A Republican Scientist in the Tradition of Franklin
Timothy Rush
- Ibero-America Needs a Space Agency!
Marsha Freeman
- Gauss's Declaration of Independence: The Fundamental Theorem of Algebra
Bruce Director

- The Case for Adult Stem Cell Research
Wolfgang Lillge, M.D.

Fall 2001



- Why You Don't Believe Fermat's Principle
Laurence Hecht
- The Scientific Renaissance of the Medieval Cathedrals
Philippe Messer
- The Paradoxes of Moving Electricity
Rémi Saumont

- Bring Science Back to Life—Vernadsky's Method
Jonathan Tennenbaum, Laurence Hecht, Wolfgang Lillge, Dino De Paoli, Lyndon H. LaRouche, Jr.
- Where Do We Stand on Cold Fusion?
Edmund Storms

Spring 2001



- The New Nuclear Power
Marjorie Mazel Hecht
- The Natural Science of Goethe
Ralf Schauerhammer
- Anti-Gravity: Myth or Reality
Rémi Saumont

- Magnettrain: High-Speed Rail for the 21st Century
Laurence Hecht
- Terraforming Mars to Create a New Earth
Marsha Freeman

Fall 2000

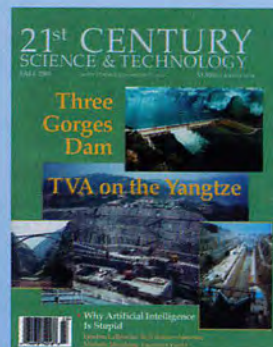

WHY ARTIFICIAL INTELLIGENCE IS STUPID:

- Where Do We Attach the Head?
Lyndon H. LaRouche, Jr.
- The Artificial Reputation of John von Neumann's Intelligence
Ralf Schauerhammer

Winter 2001-2002



- Pedro Paulet: Peruvian Space and Rocket Pioneer
Sara Madueño Paulet de Vasquez
- Pitcairn Island Petroglyph Deciphered
Ross Perfect

Summer 2001



- Biography of Barry Fell, Part 2
Julian Fell

Winter 2000-2001



- On the Difference between Living and Nonliving Bodies in the Biosphere (1938)
Vladimir I. Vernadsky

- Programmed to Kill: Video Games, Drugs, and the 'New Violence'
Michele Steinberg
- Three Gorges Dam: The TVA on the Yangtze River
William C. Jones and Marsha Freeman

To order, send dates of back issues requested and a check or money order (U.S. currency only) for \$5 for each issue ordered (\$8 foreign), to

21st Century P.O. Box 16285, Washington, D.C. 20041
Also available by credit card on the website: www.21stcenturysciencetech.com



Krafft A. Ehrlicke

Ehrlicke painted many scientific views of planets, space vehicles, and colonies on the Moon. In this 1979 painting, he depicts Mars as a planet with an active geologic past.

**TRAVELLING TO MARS IN 2050—
AS SEEN BY KRAFFT EHRLICKE IN 1948**

This first publication of a newly discovered short story by visionary space scientist Krafft Ehrlicke gives readers a vivid sense of Ehrlicke's optimistic idea that man has an "extraterrestrial imperative" to expand development over the entire Universe. Ehrlicke's fiction, "Expedition Ares: A Saga from the Dawn of Interplanetary Travel," like his technical writings, provides a blueprint for the role of space colonization in a culturally and economically sound society.

HOW THE PLANETS DETERMINE EARTH'S CLIMATE

Distinguished earth scientist Rhodes Fairbridge considers the evidence demonstrating how the orbital cycles of the massive planets affect Earth's climate through the dynamic effects of their motions on the Sun.

A torque exerted by the motion of the massive planets, the "solar jerk," may have an important cyclical effect on Earth's climate. This image of the Sun was taken by the SOHO Extreme Ultraviolet Imaging Telescope.

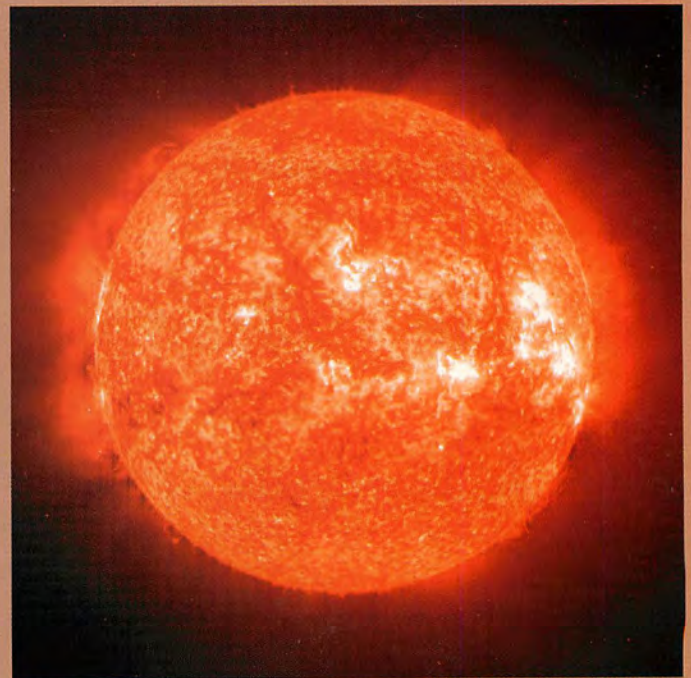

NASA Goddard Space Flight Center