

# 21<sup>st</sup> CENTURY SCIENCE & TECHNOLOGY

SUMMER 2003

[www.21stcenturysciencetech.com](http://www.21stcenturysciencetech.com)

\$3.50/IN CANADA \$4.50

THE MAGLEV  
REVOLUTION

## Science and the LaRouche Youth Movement

- Moon's Nuclear Model
- Kepler's Snowflake
- The Solar Fraud



# LaRouche's 'University on Wheels'



Chris Lewis

*Limari Navarette from California demonstrates properties of the Platonic solids and their relationship to the sphere, at a pedagogical festival in Wiesbaden, Germany, May 31, attended by youth from France, Germany, Denmark, and Sweden.*



Charles Spies

*Nick Walsh (l.) and Jon Stuart use an orange to demonstrate the impossibility of mapping the surface of a sphere onto a plane, at the California cadre school in Big Bear, April 26.*



Jason Floss

*French youth movement leader Elodie Viennot (r.) and Jean-Adrien Caldly using wooden cubes to explore the physical geometric concept of powers, in the movement's Rennes office.*



Brendon Barnett

*Jermaine Hughes demonstrates a part of the Archytas solution for doubling the cube, at the Big Bear, Calif. cadre school. The construction involves the intersection of the surfaces of a cylinder, torus, and cone, the generators of which are represented by hoops in the apparatus at left. Hughes is showing the method of finding mean proportionals. Looking on (from left) are Sky Shields, Motoki Kasai, and Daniel Bayer.*

# 21<sup>st</sup> CENTURY SCIENCE & TECHNOLOGY

Vol. 16, No. 2

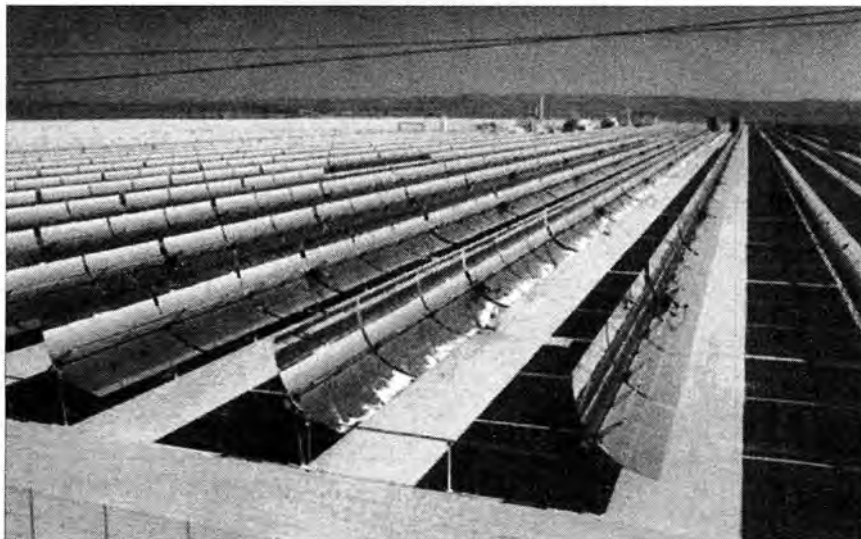
Summer 2003

## Special Report

- 5 **How It Is, That Every American Shall Come To Understand Gauss**  
*Sky Shields*
- 10 **Learning the Science of Pedagogy**  
*Riana St. Classis*
- 13 **LaRouche in Dialogue with Youth**  
Lyndon H. LaRouche talks with youth from three continents.

## Features

- 26 **The Elements, the Solar System, and The Prebiotic Principle**  
*Laurence Hecht*  
A new look at the geometric model of the atomic nucleus proposed by Robert J. Moon, a physical chemist in the anti-Bohr tradition.
- 35 **Six-Cornered Snowflakes and Five-fold Symmetry**  
*Ralf Schauerhammer*  
How Johannes Kepler's examination of "nothing," produces something to think about.
- 43 **MAGLEV: The New Mode of Transport For the 21st Century**  
*James Powell and Gordon Danby*  
The inventors of the world's first superconducting maglev system tell how magnetic levitation can revolutionize world transportation, and even carry payloads into space.



Warren Gretz/www.nrel.gov

## Departments

### EDITORIAL

- 2 **Science and the LaRouche Youth Movement**  
*Laurence Hecht*

### 3 LETTERS

### 4 NEWS BRIEFS

### BOOKS

- 58 **The Solar Fraud: Why Solar Energy Won't Run the World**  
by Howard C. Hayden  
*Reviewed by Greg Murphy*
- 60 **The Conquest of Space**  
by David Lasser  
*Reviewed by Marsha Freeman*
- 64 **Sticky Night Skies**  
by Laurence Holt Books  
*Reviewed by Rick Sanders*

---

On the Cover: LaRouche Youth Movement leader Sky Shields demonstrates helicoidal minimal surface formed by soap film. Photo by Robert Lucero; cover design by Alan Yue.

### THE SOLAR FRAUD

To keep the huge Solar Electric Generating System in Kramer, Calif. producing a mere 103 MW of electricity (about one-tenth that of conventional power plants), requires washing several million square meters of mirror 25 times a year, plus a natural gas back-up system that can produce power during cloudy weather. See p. 58 for more.

# Science and the LaRouche Youth Movement

**EDITORIAL STAFF**

**Editor-in-Chief**

Laurence Hecht

**Managing Editor**

Marjorie Mazel Hecht

**Associate Editors**

Elijah C. Boyd

David Cherry

Marsha Freeman

Colin M. Lowry

Gregory B. Murphy

Elisabeth Pascali

Richard Sanders

Charles B. Stevens

**Books**

David Cherry

**Art Director**

Alan Yue

**Advertising Manager**

Marsha Freeman

**SCIENTIFIC ADVISORY BOARD**

Francesco Celani, Ph.D.

Hugh W. Ellsaesser, Ph.D.

Bertha Farfán, M.D.

James Frazer, Ph.D.

John Grauerhoiz, M.D.

Emmanuel Grenier

Lyndon H. LaRouche, Jr.

Wolfgang Lilje, M.D.

Ramtanu Maitra

Thomas E. Phipps, Jr., Ph.D.

B.A. Soldano, Ph.D.

Jonathan Tennenbaum, Ph.D.

**21st Century Science & Technology** (ISSN 0895-6820) is published 4 times a year in 2000, every third month, by 21st Century Science Associates, 60 Sycolin Road, Suite 203, Leesburg, Va. 20175. Tel. (703) 777-7473.

Address all correspondence to **21st Century**, P.O. Box 16285, Washington, D.C. 20041.

Second-class postage is paid at Leesburg, Va. and additional mailing offices.

**21st Century** is dedicated to the promotion of unending scientific progress, all directed to serve the proper common aims of mankind.

Opinions expressed in articles are not necessarily those of 21st Century Science Associates or the scientific advisory board.

We are not responsible for unsolicited manuscripts.

Subscriptions by mail are \$25 for 6 issues or \$48 for 12 issues in the USA and Canada. Airmail subscriptions to other countries are \$50 for 6 issues. Back issues are \$5 each (\$6 foreign). Payments must be in U.S. currency.

POSTMASTER: Send address changes to 21st Century, P.O. Box 16285, Washington, D.C. 20041-0285.

Copyright © 2003

21st Century Science Associates

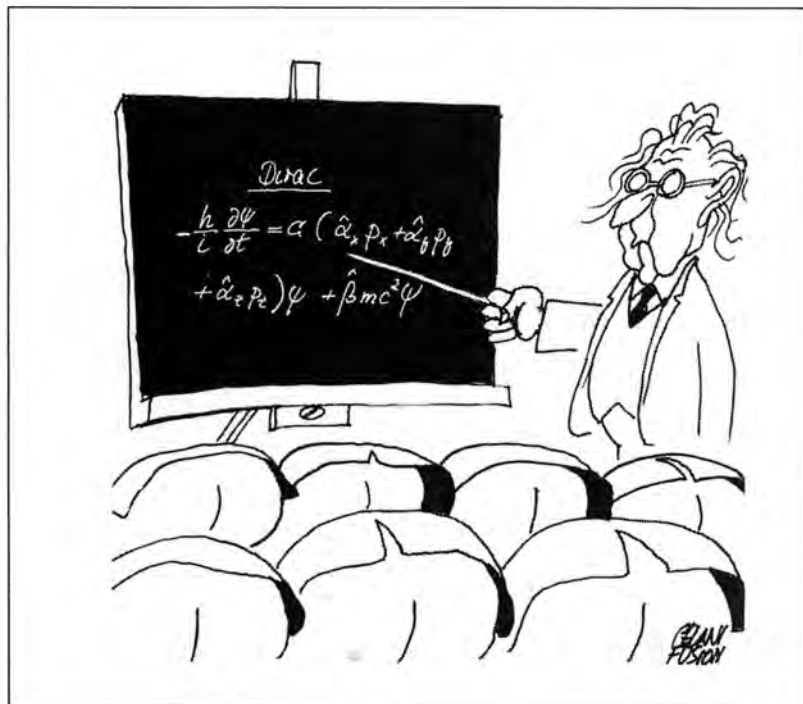
Printed in the USA ISSN 0895-682  
www.21stcenturysciencetech.com

You won't read about it in *Science* or *Nature*, but the big news in science today is the growth of a youth movement, committed to the principle of discovering the truth.

As the articles in our Special Report demonstrate, this process is already well under way. We have now around us, in a social-political and intellectual process that has chosen to name itself the LaRouche Youth Movement, a core grouping of several hundreds of very serious young people in the 18 to 26 age bracket. Around this rapidly expanding core is a very much larger circle of university-age youth, debating the ideas which are being forcefully presented to them by this dedicated cadre of thinkers.

The centerpiece of the educational program for these youth has been the

challenge to master Carl Friedrich Gauss's 1799 proof of the Fundamental Theorem of Algebra. In that revolutionary paper, the 21-year-old Gauss dismisses the earlier proofs of three of the most prestigious figures in 18th Century mathematics—d'Alembert, Euler, and Lagrange. The problem, Gauss notes, is that they have accepted, without proof, the existence of the "imaginary" or "impossible" number, and thus proven nothing. It were necessary, Gauss insisted (then, as always) to establish the physical-geometric basis for the existence of this new type of magnitude, before invoking it in a proof. Hence his construction of the domain of the doubly extended magnitude, in which the new species, known as complex number, may exist.



No more of this!

The truth is, that very few, even among the ranks of professional mathematicians who would claim to know Gauss's proof, have actually mastered this relatively elementary lesson. And from that systemic failing, are derived an entire family of problems embedded in the axiomatic underpinning of modern mathematical physics.

Thus, the first challenge facing anyone from the generation of scientists trained by those methods of lesser intellectual rigor which have prevailed in our lifetimes, is to re-educate oneself, on the principle that nothing is known which is not demonstrable by the methods of physical-geometric constructibility demanded by Gauss. That will be best accomplished, in the course of carrying out the second challenge, which is to take up the awesome responsibility for properly educating this new generation.

Nothing less than a most rigorously Socratic approach will suffice: Nothing can be asserted which is not known. On truthful self-examination, most will find that they possess a great deal of accumulated learning, with huge holes where the actual proof should lie. Because the method of knowing how we know has been abandoned in science education, often on grounds of efficacy, most of what is called scientific knowledge today is no different than articles of faith. That practice must end. The guiding principle must be that every assumption employed must be rigorously examined. No hypothesis, whether it be an imaginary number, or an elementary particle, is presumed valid until the experimental anomaly suggesting its existence has been demonstrated.

The task is challenging, but should not be daunting. The best way to begin, we have found, is to begin. To those with a passionate commitment to the pursuit of truth, there should be nothing more exciting than the prospect of being able to participate in the education of a new generation dedicated to this principle.

Please join us in helping to shape the intellectual leaders of this abandoned, "no future" generation, into the Renaissance generation they wish to become. You have nothing to lose but your pessimism and despair.

—Laurence Hecht

## Letters



### Radiation Expert On Curie

#### To the Editor:

I wish to correct one error in the very interesting article on Maria Skłodowska Curie, which appeared in your Winter 2002-2003 issue. I liked the article very much, especially the part on her role in America, unknown to me. I sent four issues to the Society Maria Skłodowska-Curie in Homage in Warsaw, and four to the headquarters of the Polish Society of Oncology in Krakow. I received positive comments.

The error relates to the history of our understanding of radioactivity. The article states on page 36, "It was Marie Curie's job to explain to the world what this phenomenon [radioactivity] was. . . ." This is not quite true. In their early papers, Maria Skłodowska and her husband proposed a wrong explanation for the essence of radioactivity: They regarded radioactive atoms as a kind of condenser, trapping the radiant energy incoming from the Cosmos.

It was Henri Becquerel, who, in 1901, first suggested that radioactivity is caused by breaking apart of the radioactive atoms.<sup>1</sup> Maria and Pierre strongly objected to this idea in a paper presented to the French Academy, on their request, by its member Becquerel (a sign of his magnanimity).<sup>2</sup> Here they noted that "activity does not vary with time," and assumed that radioactive atoms absorb their energy from an external source. This paper was a continuation of what Maria had written in 1898:

"Interpreting spontaneous radiation of uranium and thorium, one can imagine that all the space is traversed constantly by rays analogous to Roentgen rays but much more penetrating, and that these rays can be absorbed only by certain elements of

great atomic weight, such as uranium and thorium."<sup>3</sup>

What she wrote about all the space being filled with natural radiation (later called cosmic and terrestrial) was lucid, far-sighted, and was proven correct. The explanation of the nature of radioactivity was given in a two-part paper by Ernest Rutherford and Frederick Soddy, in which they presented their theory of radioactive disintegration.<sup>4</sup>

**Zbigniew Jaworowski,  
M.D., Ph.D., D.Sc.**

**Central Laboratory for Radiological  
Protection  
Warsaw, Poland**

#### Notes

1. H. Becquerel, "Sur la radio-activité de l'uranium," *Comptes Rendus, Acad. Sci., Paris*, Vol. 133:977-980 (1901).
2. P. Curie, M. Curie, "Sur les corps radio-actifs," *Comptes Rendus, Acad. Sci., Paris*, Vol. 134:85-87 (1902).
3. Mme. Skłodowska Curie, "Rayons émis par les composés de l'uranium et du thorium," *Comptes Rendus, Acad. Sci. Paris*, Vol. 126:1101-1103 (1898).
4. E. Rutherford, and F. Soddy, "The Cause and Nature of Radioactivity," *Philosophical Magazine*, Part 1: Vol. 4:370-396 (1902); Part 2: Vol. 4: 569-585 (1902).

### A Real Love For Curie

#### To the Editor:

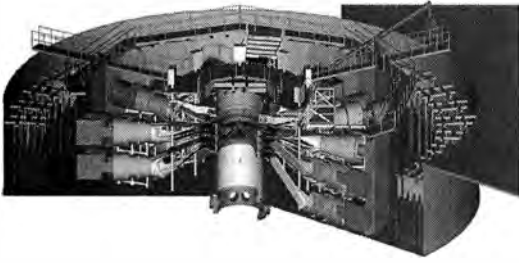
I recently read the beautiful article on Marie Curie in your Winter 2002-2003 issue. On a whim, I picked up the issue and opened it up. Denise did a wonderful job. . . . Almost 20 years ago, I shared an apartment with her and her husband Roger. Around that time, I also did a lot of research on Curie, and submitted some material to your prior group, the FEF [Fusion Energy Foundation]. . . . Denise's article flowed with real love of the subject, and gave an excellent overview. . . .

**Paul Kacprzak**

### Correction

The correct e-mail address for the Krafft A. Ehrlicke Institute for Space Development, listed on p. 44 of the Spring 2003 issue, is

KrafftEhrlickeInst@sbcglobal.net.



Courtesy of Sandia National Laboratory  
*Illustration of the Z-pinch fusion device. The target chamber is in the center of the central cylinder, where the fusion reaction takes place.*

### FUSION ENERGY ACHIEVED IN SANDIA NATIONAL LAB'S ZETA PINCH DEVICE

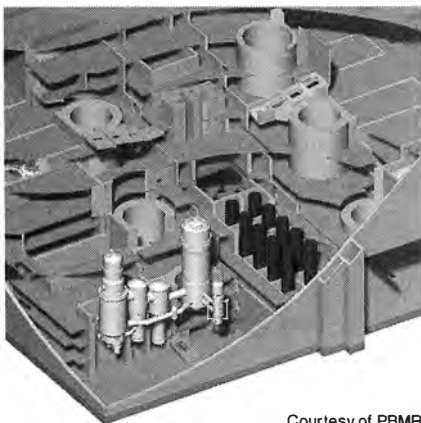
Scientists from the Sandia National Laboratory in New Mexico announced that they had achieved substantial nuclear fusion for the first time on their pulsed-power Z-machine. Dr. Ramon J. Leeper, director of the Sandia effort, reported the details of the experiments at a meeting of the American Physical Society in Philadelphia, April 5-8. "It's the first observation of fusion for a pulsed-power source," Dr. Leeper stated. In the Z-pinch, the energy output of the Z-accelerator-machine is converted to soft X-rays, which then impinge on small pellets, the size of BBs, containing hydrogen fusion fuel. The soft X-rays ablatively drive the implosion of the BB-sized pellets—targets—by burning off a small layer on the surface. The implosion then compresses the fusion fuel to high densities and temperatures like those seen in the hydrogen bomb and at the center of stars.

### CLIMATE SCIENTISTS FIND 20TH CENTURY TEMPERATURES 'NOT SO HOT'

The 20th Century is neither the warmest century nor the one with the most extreme weather of the past 1,000 years, concluded researchers at the Harvard-Smithsonian Center for Astrophysics, after examining and compiling results from 240 scientific studies. The review also confirmed that the Medieval Warm Period of 800 to 1300 A.D. had much higher temperatures in many parts of the world than that of the 20th Century, and that the Little Ice Age of 1300 to 1900 A.D. was a worldwide phenomenon. Many climate indicators were reviewed, including borehole data, glacier advances or retreats, pollen, tree ring growth, fossils, seafloor sediments, and shifting tree lines. The study was funded by government agencies and the American Petroleum Institute.

### KENYA'S LEADING MEDICAL OFFICIALS PROPOSE REINTRODUCTION OF DDT

Leading health officials in Kenya have proposed the reintroduction of DDT to stop the spread of malaria, which now kills 700 Kenyans per day. The campaign for DDT was launched this spring by Kenya's major research institute, KEMRI, whose director, Dr. Davy Koech, said that the country was in a dilemma and must act fast to safeguard the health of the general public. KEMRI's study proposing DDT was supported by top medical officials. The only option in combatting malaria is to turn to DDT, Dr. Richard Muga, Director of Kenya's Medical Services, told the *East African Standard*. Kenya banned DDT in 1986, a ban that the Minister for Environment and Natural Resources, Dr. Newton Kulundu said April 19, may have been out of an exaggeration of its dangers. Countries that have re-introduced DDT have much lower malaria rates. (For more on DDT, see *21st Century*, Fall 2002 articles and [www.21stcenturyscience.com](http://www.21stcenturyscience.com))



Courtesy of PBMR  
*Cutaway view of the plan for a multi-module PBMR complex, with 8 nuclear units.*

### CHIMPS 'SHOULD BE RECLASSIFIED AS HUMANS'? BANANAS!

Some scientists are so upset with the traditional classification of human beings as distinct from animals, that they argue in *The Proceedings of the National Academy of Sciences* that chimpanzees, which share 99.4 percent of human genes, should be reclassified as human beings. "We humans appear as only slightly remodelled chimpanzee-like apes," claims one of the authors.

### SOUTH AFRICA'S PEBBLE BED REACTOR READY FOR CONSTRUCTION STAGE

The South African utility, Eskom, is ready to proceed to the next stage of South Africa's Pebble Bed Modular Reactor (PBMR) project, subject to the required approvals being issued—a nuclear license and the approval of the environmental impact statement. The PBMR is a fourth-generation nuclear reactor design, which is super-safe, meltdown-proof, modular, and mass-producible. In May, the Pretoria High Court struck down a challenge to the project by the environmental group Earthlife Africa. Eskom's chief executive said that the company viewed the PBMR "as a strategic National Demonstration Project with the potential to bring major macro-economic, social, and strategic benefits for South Africa as a whole."

# How It Is, That Every American Shall Come to Understand Gauss

by Sky Shields

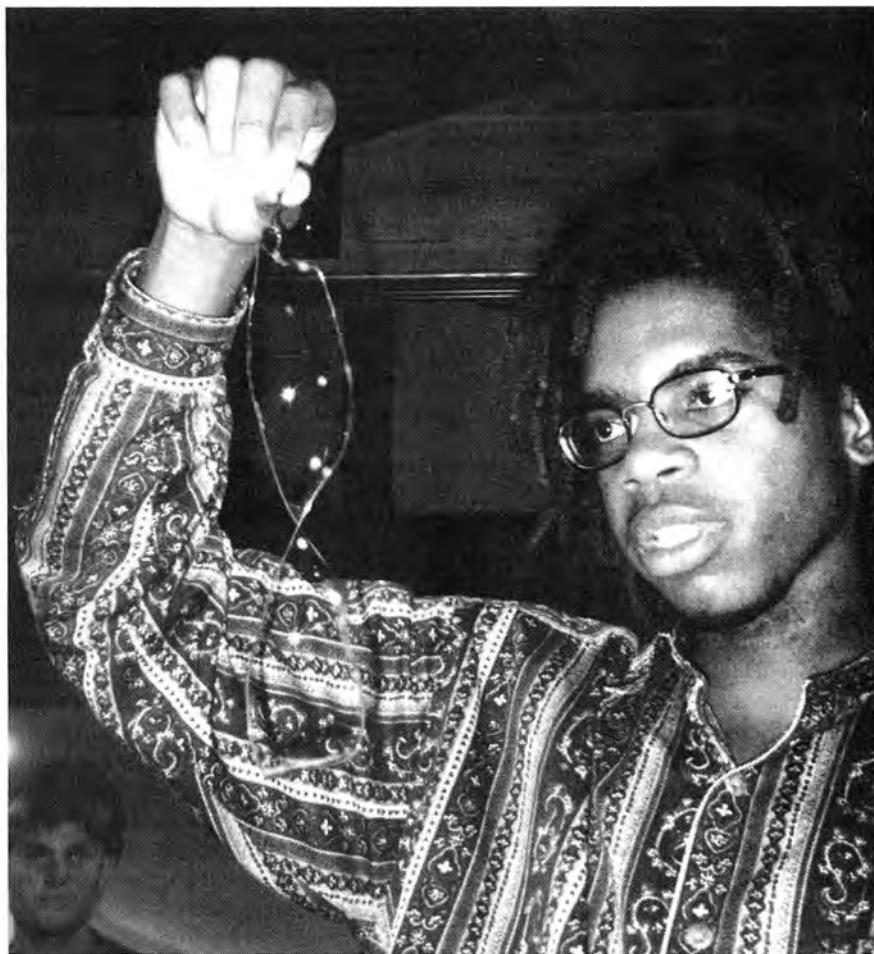
May 22, 2003

The past several weeks featured five, weekend-long educational events for the youthful organizers of Lyndon LaRouche's Democratic Presidential campaign—in Los Angeles, Philadelphia, and three held simultaneously by telephone hook-up in Seattle, Germany, and Mexico. Each of these intensive educational weekends, which we have called cadre schools, began with a short address by LaRouche, followed by a lengthy question-and-answer session with him, probing the deepest issues of philosophy, science, history, and art.

Each cadre school also featured what was termed a "pedagogical festival," where demonstrations of physical scientific principles that had been worked out by the youth themselves were presented. These demonstrations were an inflection point in a long process of intellectual development, which we have carried out for the growing numbers of full-time and part-time activists of the LaRouche Youth Movement.

This process had really begun in earnest, when a small group of us in Los Angeles took up Lyndon LaRouche's challenge to master Carl Friedrich Gauss's 1799 proof of the Fundamental Theorem of Algebra.<sup>1</sup> LaRouche challenged us to "know truth"—to go beyond the ability to repeat taught knowledge (in the way we were instructed in school), to be able to know *how we know*. He chose the mastery of the 1799 proof of the Fundamental Theorem to initiate this process.

In that 1799 proof, Gauss demonstrates that, contrary to the lies of Euler, Lagrange, and the Bush Administration chickenhawks—neither mathematics,



Robert Lucero

Author Sky Shields demonstrates helicoidal minimal surface formed by soap film.

nor the universe, can be reduced to a set of *a priori* axioms and postulates, from which history supposedly unfolds inevitably, apart from mystical interventions by little green men, or the violent fits of arbitrary impositions of will by the Nietzschean mathematicians, and the would-be imperialists who have created them.

Our initial intent was to try to establish, in a small core group, a certain level of competence in, at least, reading the topics contained therein. The plan

was then to disseminate this throughout the youth movement as a whole, in order to achieve the mental, moral, and strategic effects Lyndon LaRouche had called for. This all exploded much sooner than we had intended, however, when the rest of the youth movement, hearing that work on the Gauss paper had begun, insisted on broadening the work group.

It became clear that the problem of working through the Fundamental Theorem was not just a problem of the

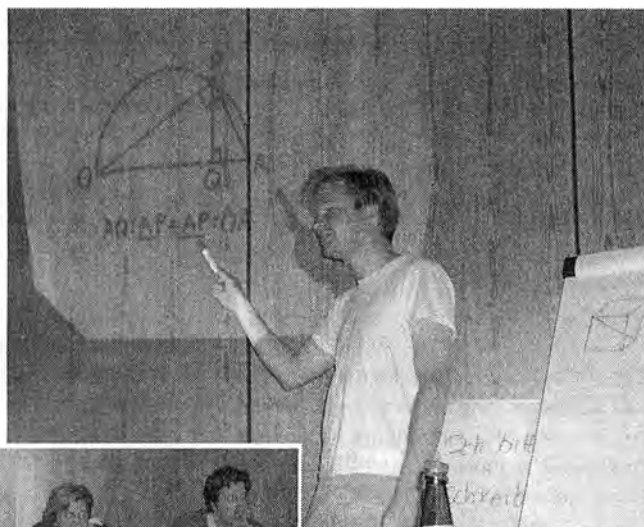
Fundamental Theorem. There existed an entire historical and intellectual context, "a geometry," in which it first had to be situated. The bulk of what we needed in order to situate Gauss's breakthrough properly, in terms of the historical fight as well as in terms of the epistemology, was contained in the pedagogical series "Riemann for Anti-Dummies," assembled by one of our senior advisors, Bruce Director.<sup>2</sup>

In this series, Director and others, as part of a program leading up to mastering the mathematics of Bernhard Riemann—which was required to understand the LaRouche-Riemann method of economic forecasting—have presented a thorough working-through of elements of the work of Riemann's teacher, Carl Friedrich Gauss. For the rest, we've begun a process that shouldn't find a reason to slow down any time in the next 10 years or more.

### What, Really, Is Algebra?

For instance: What is the system, algebra, that the algebraists LaGrange and Euler mystified? Is it really the deductive set of symbol manipulations learned, like seal training, in algebra class? As an antidote to such training, we acquired copies of the original algebra book, the *Hisab al'Jabr w'al Maqabala*, by Al Kwarizmi,<sup>3</sup> to work out what this system, *al'Jabr*, really was, because we understood that it was this *physical* system that Gauss drove to the point of breakdown, in order to force a breakthrough into what he called a "higher space." One group of students began a project of working, chapter by chapter, through Gauss's *Disquisitiones Arithmeticae*,<sup>4</sup> which Gauss worked on concurrently with his Fundamental Theorem paper (both of which were written in his late teens and early twenties). We created an environment where people are often up until two to four o'clock in the morning, working intensely on peda-

*A pedagogical evening in Wiesbaden, Germany, in April 2003, where Los Angeles LaRouche Youth Movement organizer Jason Ross (right) discusses the problem of doubling the cube.*



Kevin Desplanques



gogical projects, in small groups, mostly informally. This comes on top of the regular, scheduled, class sessions each week.

Pushing this process quickly brought out two, important problems: (1) We had far too many people for only one or two people to teach, and (2) people had severe blocks on the subject of mathematics.

The first of these was, of course, a welcome problem. It's a characteristic problem of a healthy economic process. It was resolved by the development of a capability, later identified by another of our advisors, Jonathan Tennenbaum, as a "brigade system" (referring to the education of the French military engineering corps in the Ecole Polytechnique under Gaspard Monge and Lazare Carnot in the late 18th Century). We established a network, initially internal to the West Coast offices (Seattle, San Leandro, and Los Angeles), and which has now spread both nationally and

internationally, for collaboration on pedagogical *method*, as opposed to simply the pedagogical topics.

This question of teaching, or pedagogical composition, effectively cemented the topic of discussion as being a subsuming *idea*, rather than simply the series of predicated facts which could be organized, like notes in a musical piece, to convey that idea. The effect was necessarily to force the adoption of a *producer*, as

opposed to a *consumer*, identity for certain youth organizers. A consumer, such as an average American today, interacts with the world merely in terms of simple object relations. The consumer's world is a series of objects—either of desire or of discomfort—and symbols, such as those of algebra (as presented in any modern textbook) severed from the physical universe, to be manipulated according to a set of rules, in order to obtain desired results.

The producer is capable of seeing an entire developmental process enfolded in every product, where the consumer only sees "things to buy." Whether it is the economic history and human effort which bring a product into being, or the history of the human effort behind the idea from which a mathematics is derived: these should be the real objects of human thought. To the extent that this sense has been imparted throughout the movement, we have developed a far more efficient network of teachers than



we would have otherwise.

### Educating All

The second problem was a much more insidious one. We have an organization that is clearly unique in many respects, but one stands out: LaRouche campaign organizers come from almost every different background possible. There are no requirements to join the campaign, other than a passion to do good for humanity. We are a proof of the principle contained in the Declaration of Independence, "that all men are created equal"—that all humans are born with the exact same capacity for human reason, and the absorption, generation, and communication of creative discovery. Therefore, the people working on the projects cited are, for the most part, not a bunch of "science buffs," but rather people who recognize this as part of a higher, more universal course of study.

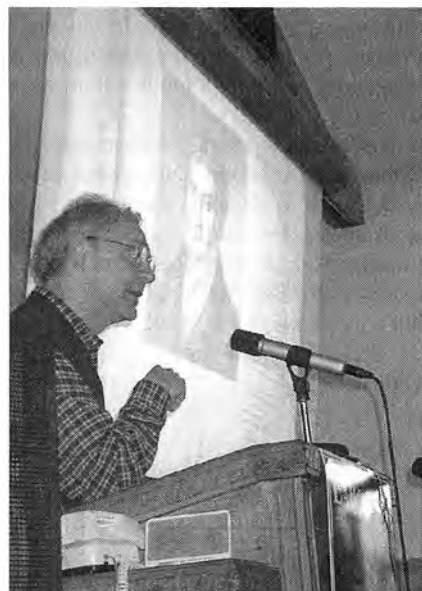
Reinforcing this understanding is not easy. Most people have undergone so much Social Darwinist brainwashing in the course of their education, that they block themselves psychologically on certain subjects. Math is possibly the most common block, but this is true for all so-called "subjects": "I'm not a math person"; "I'm not a history person"; "I'm not artistically inclined"; or, "I'm not into politics," are all considered perfectly normal things to say, by current social standards. But, they are all absolutely absurd.

All human beings, all children, have a natural curiosity in all things. Only some sort of trauma in their youth would serve to sour them on different subjects. Math class is often this traumatic experience. Most math classes in elementary and high schools have the same Darwinist character as a dog breeder's kennel. Instead of actually rediscovering the greatest ideas in human history, and making that process the subject of human mentation, students are trained to perform tricks (admittedly, sometimes spectacular feats of rote calculation) for which they are given treats and good grades. Some make it as prize show dogs, and are then tracked as math studs, to be mated under the watchful eye of a professor or peer review board. Others don't quite make the cut, and are told to study liberal arts (or perhaps home economics).

In the end, nobody ends up knowing mathematics, but a few can perform great calculating feats on command. The rest end up with a different kind of traumatic damage—though both abuses need to be repaired, in order to sustain a functional revolutionary cadre. In this way, our Gauss and other pedagogical work served a dual function, as sort of psychoanalysis for the membership. Solving this second problem, served to aggravate the first, as youth movement members who had been terrified of the science work, say, six months before, finally decided to dive in, and needed to be caught up to the rest.

It was this apparatus that was brought to bear around the Los Angeles Cadre School, and pushed into a phase shift. Jonathan Tennenbaum presented the LaRouche Youth Movement with what he called a "shopping list" of pedagogical demonstrations. Among the included projects were:

- constructions for demonstrating Kepler's determination of the planetary orbits;
- demonstrations of Fresnel's work on light;
- Abraham Kaestner's pioneering work on mathematics, which brought us Gauss, and later Riemann;
- a demonstration and constructions of Leonardo da Vinci and Luca Pacioli's



Brandon Barnett

*Jonathan Tennenbaum talking about Gauss at a LaRouche Youth Movement cadre school in Los Angeles.*

work on the Platonic solids and the golden section;

- a lead-in to Gauss's work on the divisions of the circle;
- apparatuses to demonstrate da Vinci's work on waves, founding the study of hydrodynamics, which led to Riemann's anticipation of shockwaves in air;
- a presentation of the constructive principles behind Brunelleschi's dome in Florence, including least surfaces, and the catenary; and finally,
- a physical demonstration of the Pythagorean comma, and the goldmine of paradoxes within music and the human voice.

This had the equivalent effect of a science-driver economic project<sup>5</sup> for the members of the youth movement, forcing the development of new skills, in particular increasing the capability and experience at physical constructions and demonstrations of principle, including design and execution of the apparatuses involved, a capability which had been limited prior to this.

The idea now is to push this process even further. An intensive cross-continental project, studying the works of Lazare Carnot, Gaspard Monge, and the Ecole Polytechnique has begun. Also, projects have been either proposed or taken up on the geometry and engineering of Gaspard Monge, projective geometry, techniques for identifying a given surface by its local characteristics, Christiaan Huygen's work on light and wave fronts, Leonardo da Vinci's work on perspective and his work on translation of motion, and consistently coming back to mainstays such as Gottfried Leibniz's differential calculus, and the other projects mentioned.

Multiple translation projects, from French and German original texts, into both English and Spanish, are also in the works. It is for this reason that LaRouche has dubbed us, no longer the "No-Future generation," but rather a "Renaissance generation." Much fun will be had, and much trouble caused, in the days, weeks, and months to come!

### Notes

1. Carl Friedrich Gauss, "New Proof of the Theorem That Every Algebraic Rational Integral Function in One Variable Can Be Resolved into Real Factors of the First or the Second Degree" (Helmstedt: C. G. Feckeisen's, 1799). English translation by Ernest Fandreyer,

Department of Mathematics, Fitchburg State College, available through <http://www.theacademy2004.com>

2. This entire series can be found on the website of the LaRouche Youth Movement, <http://www.theacademy2004.com>, in the "Riemann for Anti-Dummies" section.
3. *Robert of Chester's Latin Translation of the*

*Algebra of Al-Khowarizmi* with an Introduction, Critical Notes, and an English version by Louis Charles Karpinski (New York: The Macmillan Company, 1915).

4. Carl Friedrich Gauss, *Disquisitiones Arithmeticae*, transl. Arthur A. Clarke, S.J. (New Haven: Yale University Press, 1966)
5. For more information on science-driver econom-

ic projects, like the Apollo Mission to the Moon, the Manhattan Project, the original Strategic Defense Initiative as proposed by Lyndon H. LaRouche, Jr., and the principle behind them, see Lyndon LaRouche's essays "The Gravity of Economic Intentions: The Science Driver Principle in Economics," and "SDI Revisited: In Defense of Strategy" at [www.larouchepub.com](http://www.larouchepub.com).

# Pythagoras Has One Professor Freaking Out at Exodus to LaRouche

LaRouche Youth Movement organizers have been regularly deploying to college campuses throughout the United States and globally, attempting to provoke a discussion of the sort of ideas required to head off a civilizational crisis of war and depression. We generally succeed, but there have been a few notable exceptions.

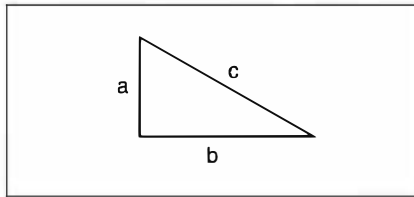
Since we have emphasized mastery of the Pythagorean Theorem (that is, understanding *why* it is true, not simply what the formula is) in our own educational work, organizers frequently challenge students they meet to produce a proof. The purpose is to demonstrate the difference between mere taught knowledge and actual understanding.

A reporter for the San Francisco State campus newspaper, the *Golden Gate*, was apparently provoked by such a challenge. We would have preferred that he try to think through the matter for himself. Instead, it appears he took the opposite approach, and sought the opinion of an "authority," in this case the chairman of the college math department. This "expert's" cited comments seemed so foolish to us, that we had a look at the curriculum he teaches. It proved to be a perfect example of the problem we are criticizing.

First, we cite the campus newspaper report:

"The idea of the missing fraction that represents the hole between one and two is more than 2500 years old, dating back to Pythagoras," says SF State Mathematics Department Chair Dr. David Meredith, who says he once lost a student to LaRouche's 'cult.' He adds that modern mathematics instruction encourages students to learn and seek out new truths on their own, rather than mimicking math as taught."

Figure 1

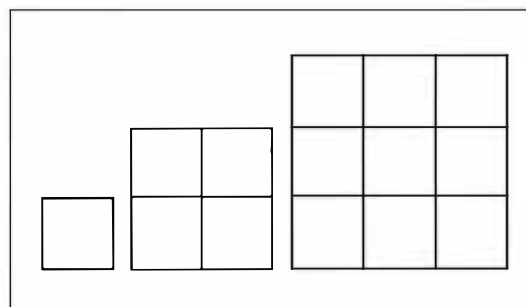


This author obtained the San Francisco State mathematics curriculum from the school's website, to find out what *is* taught there, that Meredith claims allows students to "seek out new truths on their own." This is from the book *Elementary and Intermediate Algebra*, available in the San Francisco State campus bookstore:

"A triangle is a *right triangle* if it has a 90° or right angle. The side opposite the 90° angle is called a *hypotenuse*. The other sides are called *legs*. In any right triangle, if *a* and *b* are the lengths of the legs and *c* is the hypotenuse, then  $a^2 + b^2 = c^2$ " (Figure 1).

That's what the book's authors call "the Pythagorean Theorem." Now, what exactly does that formulation *mean*? Testing it on triangles, by substituting numbers for the lengths, a student would come to see that it seemed to "work" in every case—but why? Because the book says so?

Figure 2



The Pythagorean Theorem—or what's left of it as taught here—has, like other algebraic techniques, such as FOIL (first, outer, inner, last), "completing the square," the quadratic formula, and so on, the same significance to most modern math professors, and the victims of their malicious dog-show training, as a doll with stickpins does to a voodoo priestess: It is a mystical talisman, to be wielded in the same desperate way demonstrated by Euler, LaGrange, and D'Alembert, in Gauss's account of their attempts to prove, using taught symbol manipulation, the Fundamental Theorem of Algebra. The actual algebra (*al jabr*) of Al Quarizmi (or Khowarizmi), which this textbook formulation obfuscates (as it also does the mathematical and philosophical work of Pythagoras and the Pythagoreans), takes a quite different, even antithetical, form.

## The Real Theorem of Pythagoras

First, what does it mean to "square" a number? Is this simply the act of multiplying a given number by itself? If so, what does this have to do with the lengths of the sides of a right triangle?

The answer to this can be found in a general investigation of the properties of squares. Readers who are familiar with Plato's *Meno* dialogue, or who have attempted to solve the problem of doubling the square, know that this cannot be accomplished by simply doubling the length of one side. This action gives a square four times as large as the original; tripling the side gives a square nine times as large, and so on (Figure 2).

One can investigate the relationship between a length of line and the square con-

Figure 3

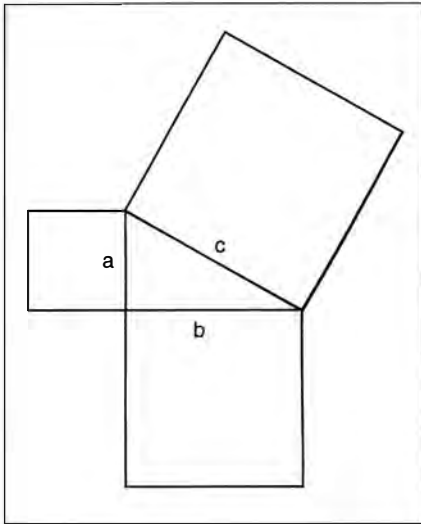


Figure 4

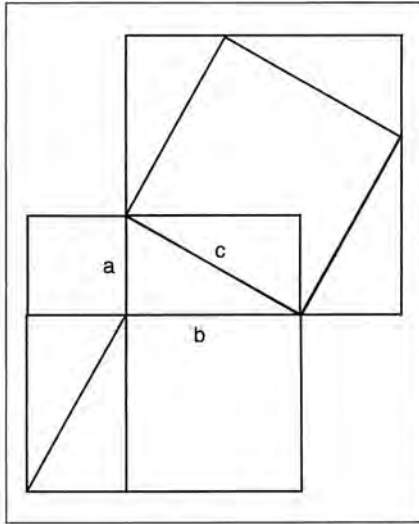
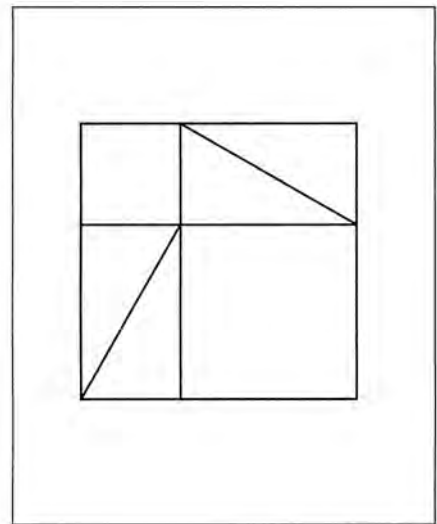


Figure 5



structed on it. It is a shorthand for this *physical geometric relationship*, which is later referred to as “squaring” a number. (Archytas, and later Gauss, demonstrate that this is a special case of a more general physical geometric conception of powers.)

Now, looking back at our triangle, “a squared” would seem to mean the square built on length  $a$ . Our theorem would then look something like the image in Figure 3. But now, we have a new problem—how do you add one square to another, and still have a square? The reader should try different methods for this, before looking at the solution we will provide here.

Now, for a demonstration (this is only one of many possible). Looking at our drawing, we see that several more triangles, each the same as our original, can be seen implicit in it. Draw these all in

(Figure 4). Close inspection will reveal two identical squares in the construction, each with a side of combined length  $a + b$ , and each containing four of the original triangles as part of its area. (One of these identical squares is pictured, by itself, in Figure 5.)

Removing the same area from each of the two identical squares—in this case the four triangles—should give us the same remaining area. But, in the one case we have two squares, the  $a$  square and the  $b$  square, left over. In the other case, we have only one, the  $c$  square, left over. But, because of our construction, these areas must be equal! That is,  $a$  squared plus  $b$  squared must equal  $c$  squared.

“But, you can’t expect people to work through *everything* like this! It would take much too long!” might be the typical argument from one of today’s “new math” professors, or perhaps from a

social climbing, young, aspiring political party hack (“This won’t help me get a high paying job! I just want to make friends and influence people.”)

But the truth is, that it is precisely because of the fact that most of those people whom we consider our political and intellectual leadership in the world today, have *not* worked through problems like this, that we are in the crisis we are in today. We have reached the end of a system, where all the currently accepted rules of economics, social relations, science, and mathematics no longer apply. And only if there is a movement in the world today, centered around rediscovering the method by which discoveries are made (not just consuming their by-products), will we be able to seek out the new ideas that are required to get us out of this mess.

—Sky Shields

## Warning: Social Climbing May Be Hazardous to Your Mental Health

Berkeley College Democrat Nasir Khan was one of those we met on campus, who rejected the challenge to grasp higher concepts. Nonetheless, though clearly exuding pride in ignorance, his published comments give an idea of the kind of debate we have provoked on college campuses. In an article in the University of California at Berkeley College Democrats magazine, the *Smartass*, Khan writes about LaRouche:

“It’s very hard to glean quite what he stands for, since his followers are quite preoccupied with explaining to bystanders what it means to be ‘sublime’ and the ‘universal principles of geometry.’ Don’t believe me? Well, as I decided to find out more about the man one day in an effort to educate myself about a group that claims to share the same party allegiance as myself, I was shocked by some of the things his recruiters told me. First of

all, they wanted me to explain to them the significance of the Pythagorean theorem, and mathematically prove it as being true. I could not, and did not quite understand how it related to politics. . . .”

Perhaps this can help to answer the question on so many people’s minds: Why can’t Democrats seem to muster the intellectual wherewithal to stop a bunch of chickenhawks from starting world war?  
—Sky Shields

# Learning the Science Of Pedagogy

by Riana St. Classis

There is a special difficulty in writing about pedagogy, for its domain is inside the human mind. One can describe the objects used to facilitate it; one can describe the concepts at which particular pedagogies are driving; one can describe its effects; but, pedagogy itself can only be experienced as the reliving of a discovery. I have watched a group of 20-year-olds struggle, yawn,

and sink ever further down in their chains, as if they were being swallowed into a pit of mud, suddenly be-

come alive and animated as if a bolt of lightning went through the room, and, in a flash, reap the fruits of the tedious previous two hours labor, producing energy that would keep them going for the rest of the night in lively conversation, and the production of geometric constructions.

The electric moment when a young woman cries out: "Oh, that's what the catenary has to do with LaRouche's economics! It's a principle of efficiency!" This is the mysterious moment of true pedagogy, of true communication. In that moment she seemingly spontaneously generates the idea that was the generator behind my organization of the pedagogical.

I could have told her, "The catenary, the form that a chain takes when it is suspended between two points, reflects the Principle of Least Action in the universe, and it is through the discovery of such principles that human beings increase their ability to survive on the planet, and this is real economics, LaRouche's economics." I could have said this, and it would have meant nothing. It required two hours of agony for us to have a meeting of the minds, and, after it occurred, infinite possibility opened before us, and no one noticed as the next four hours flew by.

*Riana St. Classis speaking at the Youth Panel of the September 2002 LaRouche conference.*



EIRNS

Lyndon LaRouche recently wrote a paper, titled "The Pantheo-cons: The Weird Religions of Cheney's Empire."<sup>1</sup> In this paper, he elaborates the particular political/cultural crisis we face at this moment, as a specific happening of universal history, using the specific to reveal the universal, general condition of man that this moment reflects. From this standpoint he defines the solution to the crisis, which is dependent on the development of an understanding and usage of a method of truthfulness, a method of knowing, by society or, at least, by a significant portion of society.

Within the first few pages, LaRouche identifies the critical, weakened condition of the minds of the population that allow the operations of a Rumsfeld and Cheney to occur. As LaRouche states in that paper, empiricism and the deductive method, based on arbitrary axioms and postulates, have been applied to religion, and have spawned the various fundamentalisms that run rampant in our society today. The religious fundamentalist's irrational belief in the literal meaning of his religious text is essentially the same as the irrationalism of today's scholars, in both the so-called humanities and hard sciences. The underlying belief is that we cannot know; we cannot know the intentions of either humans or the physical universe. All we can know is what is right in front of our faces.

As I began to understand what this meant, I comprehended what I had encountered in the various university departments in which I did time. What is taken for erudition in today's

Comparative Literature and English departments often amounts to a compulsive disorder, an obsessive fixation on word objects conceived as magic, as somehow powerful in themselves: You cannot know what the author of a text really meant when he wrote it. All you can know is words and how to manipulate them.

This is the same disorder that is revealed in the mathematics and science departments in their slavish obsession with equations and formulae, the true origin of which they are either ignorant or in which they are uninterested. For example, I never knew that quadratic equations were concerned with areas, with squares. Instead of knowing, I merely chanted the rules of operation, the deductive laws, like incantations.

It is this very fixation on sense-certainty, objects as such, that pedagogy undermines, as it directs attention toward the invisible, real universe. Like LaRouche's writings, pedagogy is located in the specificity of history, for each discovery has been made by a unique human personality at a particular moment in time, while it simultaneously elaborates the universal reflected in the particular, and so reveals to us that which remains unchanged in the ever-changing universe.

## Becoming Leaders

Etymological excursions are often used as diversionary tactics, to cover a lack of conceptual comprehension, but I hope to use etymology for the opposite effect, to aid me in unfolding what pedagogy is. The origin of the word "pedagogy" is the Ancient Greek word *paidagogas*, which is derived from the word

Science and  
the YOUTH  
MOVEMENT

for the slave (*pais*) who leads (*agogas*) the children (also, *pais*) to school, and then comes to mean the mode of instruction itself. We retain its implication of leadership. LaRouche's youth movement goes into the marketplace, creating piecemeal extensions of the Platonic Academy.

Considering the derivation of *pedagogy*, think of us making ourselves slaves to the truth, and by so doing, making ourselves free. We are children who must lead, and we must make ourselves leaders. So, what we attempt with the pedagogicals is coherent with the Greek conception of education as shown in Plato's *Meno* dialogue.

At Temple University, the LaRouche youth recently intervened in a speech by a professor, a follower of Leo Strauss, who was speaking on Plato, politics, and knowledge. A young LaRouche organizer questioned the professor about the discovery process of knowing demonstrated in the *Meno*. In the scene to which the organizer referred, Socrates goes through the process of leading a slave-boy to discover how to produce a square that is twice the area of a given square. Socrates says this is not a process of learning and teaching, but a process of reminding someone of something they already know.

Socrates speaks metaphorically, wittily reminding his listeners that a discovery takes place in the individual sovereign mind. You can lead a horse to water, but you can't make him drink. The professor said this scene was merely "ventriloquism." (In other words, the slave was incapable of making a discovery.) Another organizer objected, saying that he uses that same pedagogy all the time with people on the street, and he gets the same discovery every time. All human beings are capable of knowledge, and even a Straussian professor can make a discovery about the universe.

During the LaRouche political organization's national conference on Labor Day 2002, one of the panel discussions presented LaRouche's Youth Movement, and some of us were asked to speak. Sky Shields, a young man from Los Angeles, spoke about the hell of being a physics student imprisoned

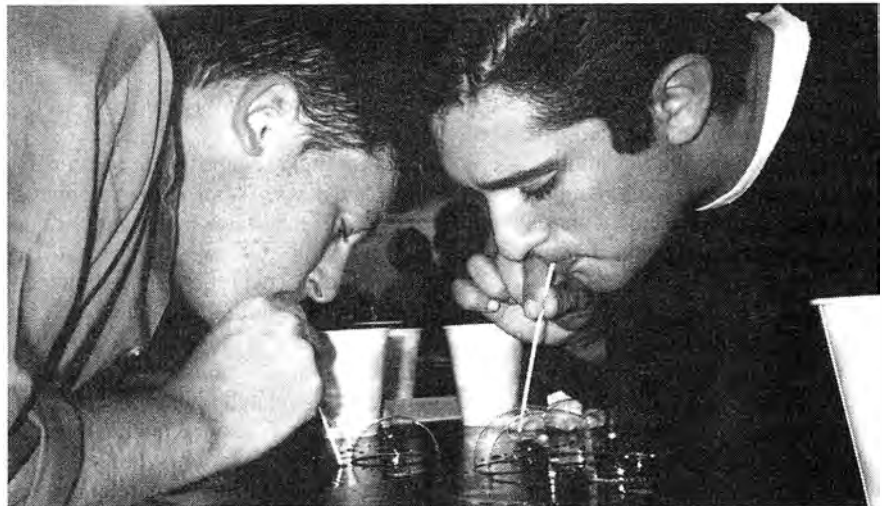
by arbitrary assumptions and the deductive method, unable to apprehend creativity as anything other than a random occurrence. After he spoke, he went to exit stage right, but found there were no stairs there. So Sky leapt from the stage, in a motion both graceful and carefree.

Afterward, one of the older members of the organization commented that in that moment he was struck: "My God, these are only children. We are going to be led by children." Sky was nonplussed, for we do not seem children to ourselves. In the intervening year, I saw what this older member saw in Sky's easy action. Like children, we become ecstatic when we discover, and usually, we are unafraid of playing. But we are,

attended four schools, in the course of getting a degree, the degree my father despaired of my ever getting, despaired because I had showed such promise when I started college.

My first year, I attended the infamous St. John's College, and gave my father his first shock when I informed him that I was not going to pursue the sciences, meaning I was not going to go into medicine. At St. John's, I became enthralled with the Greek language and classical culture, and I decided that St. John's was not rigorous enough for me.

So, I went to the school that had spawned St. John's, the University of Chicago. And there I encountered a Classics Department for the strong, and a school that is the epitome of a



Jason Ross

*Michael van der Nat (left) and Ali Razenagh experiment with soap bubbles at a California cadre school.*

for the most part, undeveloped, unfamiliar with Beauty and classical culture, unfamiliar with what it means to make a discovery, and the true power of our minds. So, we are children leading children. We are developing the principle of leadership in ourselves as we are helping develop it in others.

The first time I met Sky Shields, I had just turned 26 years old, and I was trying desperately to finally finish a bachelor's degree. I had been invited to a weekend cadre school, a student conference, at a camp in Palm Springs, California. I was immediately struck by Sky's patient and relaxed, yet extremely energetic, love for knowledge and for sharing that knowledge. I had spent nine years, and had

Hobbesian world. I asked a next-door neighbor of mine, who was madly studying for a notoriously hard genetics final, why she did not make a study group. She snorted and declared: "If I help someone, she may do better on the test than I. Then she could get into the medical school from which I am rejected."

Thankfully, I ran out of money and had to return to New Mexico. So, I attended the University of New Mexico, a school that cost, in one year, half of what one quarter-year at the University of Chicago had cost. I made my father happy by taking up the sciences again, while I continued studying Greek. But I could never quite find what I was meant to do.

In the end, I wound up at the

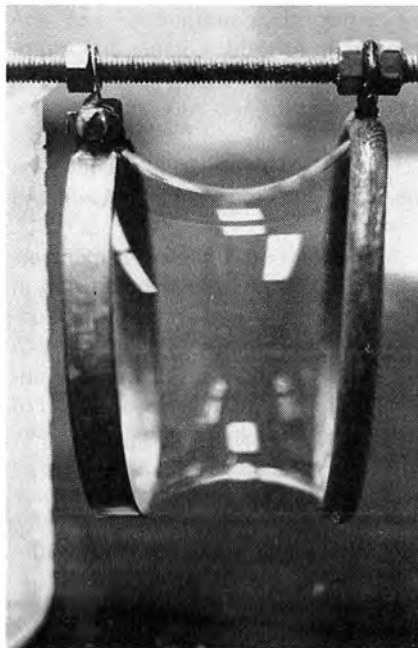
University of Washington with a couple of years toward a Chemistry degree, a couple of years toward a Fine Arts degree, and, when I went to the cadre school, I was one final paper away from getting a Comparative Literature degree.

### Soap Bubbles

We crouched on the concrete floor of the camp restroom, intensely focussed on Sky's activity. Many others had fled from the foul odor emanating from the stalls, but we few did not seem to care; we continued to play, following Sky as he posed one problem after another using soap bubbles. We, and he, were making a tremendous mess, which is why we were relegated to these surroundings.

"When you blow a bubble, why does it always take a spherical shape, no matter what the shape from which you blow it? When you blow successive numbers of equally sized bubbles onto a plate, what configuration do they take? Why? What does this tell us about the nature of space, and what does it show us about the universe? Did you ever explore any of these facts when you were taught about geometry in school? What does that say about your education?"

As a finale, Sky dipped two rings in the soap, put them together and then slowly pulled them apart. A bubble stretched between the two rings, taking a peculiar shape, taking the form of a negatively curved surface called the catenoid. Sky showed us that this is the form you would create if you spun a catenary around a horizontal axis that lay just below its minimum point. Sky



EIRNS/Stuart Lewis

*A soap film catenoid*

took out a chain, and made a catenary. He played with it for a few moments, and told us that it was investigations into the properties of this shape that led Leibniz to discover the infinitesimal calculus, as the solution to Kepler's call for the invention of a means to calculate the non-constant curvature of a planetary orbit, or the related phenomenon of the non-constant curvature of the hanging chain.

### On Squaring the Circle

Nicholas of Cusa's quadrature of the circle is a fundamental discovery, a necessary moment in the history of science,

and it is an effective metaphor for the problem with the deductive method—and with my mathematics education before I met this organization. In approximating the area of the circle by the area of a polygon, one approaches closer and closer to the area of the circle, as one increases the number of sides of the polygon. Yet, the closer one seems to get to the circle, the further away, in reality, one is. For the action of the circle is continuous and without angles; the more sides a polygon has, the more discontinuities and the more angles it will have.

When I was in school, I believed that one day I would know from whence came the equations I used. I would know how they had been conceived, and I would know their real meaning. But the further in school I got, the more unreal the mathematics I used seemed to me. The less I could comprehend how anyone could possibly have come up with it. I thought that this simply meant I was not as smart as they. If I were a genius, I would know.

That day in a smelly bathroom, I became so excited that I almost cried. Finally, after years of mathematics study, I had some sense of where what I had memorized came from, of how it was discovered, and I finally felt that it was discovered by a mind like mine. This event changed the course of my life, my behavior, and the way I saw myself in relation to the universe. But the change itself was only visible in its outward effects.

Sky led me to lead. Later, at our first cadre school in Seattle, I pulled out the soap bubbles and a length of chain. Sky had inspired a desire in me to share what he gave me that afternoon in a post-modern bathroom in a camp outside Palm Springs. Now, everywhere I go, I carry a chain for instant demonstrations of the properties of the catenary, and bubbles for pedagogical purposes. Thus, we travel out to our peers, and change them as we were changed. This is how we change society.

### Notes

1. "The Weird Religions of Cheney's Empire: The Pantheo-cons," by Lyndon H. LaRouche, Jr., appears in *Executive Intelligence Review*, May 2, 2003.

**Richard Sanders**  
*Over 15 Years Experience*  
**Specializing in Scientific & Legal Translations**  
*"I translate ideas, not just words!"*

**Translate from: German, Dutch, French, Italian & Spanish**  
**Translate into: (U.S.) English**

**1-540-668-7141 Telephone**  
**1-540-668-7142 Fax**  
**Email: ricksanders@rcn.com**

# LaRouche in Dialogue with Youth

Here are excerpts from discussions of Lyndon LaRouche with Youth Movement organizers, at cadre schools that took place during February-May 2003. More complete transcripts can be found on the LaRouche website [www.larouchein2004.com](http://www.larouchein2004.com) and the LaRouche Youth Movement website, [www.theacademy2004.com](http://www.theacademy2004.com).

May 10, Lancaster, Pennsylvania

## How Do We Measure Time?

**Question:** I've been thinking about this concept for a while now, about how physical space-time is a multiply connected process. So, I was thinking about this concept of time, and how we have

**different concepts, like the simultaneity of eternity; but, then you can also think of time as a**

**measure of change. So, then, I started thinking about, what are we measuring that change against?**

*LaRouche:* Ah!

**Question:** And then, you get in areas of composition, where now you know you're talking about the Noösphere, and then, there's still this element of time, and the ambiguities that are presented with it. So, I'd like you to comment on what this element is.

*LaRouche:* Okay. Well, it goes to the question of curvature, hmm? I don't know how much discussion among all of you there has been, about this question of Gaussian curvature, and its relationship to the idea of a Riemannian universe. Most of my work, of course, is based on that particular problem, that concept.

Now, as I've described it before, but just to situate this for everyone: If you imagine ancient man, that is, ancient intelligent man, looking at the nighttime sky, on a clear night, and seeing a panoply of stars, and also planets, and some other objects floating around up there, and they would imagine the universe to be, in a sense, like a big spheri-



Chris Lewis/EIRNS

*LaRouche and youth movement leaders at a March 2003 conference in Germany.*

cal bowl, a container which they're in. Now, they don't know how far distant—that is, how far that surface is from where they're standing—but they imagine that, someplace out there, there is a point, a surface, which you can see the inside of, and where all these different objects, stars and so forth, might be moving. And you try to measure the relationship among the movements among those bodies, the way ancient people constructed these astrological schemes; calendar schemes for the annual calendar, things of that sort.

Now, you call that the sensorium, this imagination—you project a sphere, that you're inside a sphere; you're on some normalized point inside the sphere, and you're looking up toward the interior surface of the sphere, in which all these objects are moving about as light points: Is that real?

And then, you find out, that it's not real. It is real, it's a real shadow of reality, but it's not the reality as such. This, of course, is the significance of, among other things, Kepler's discovery. When Kepler discovered that the motion of the planets, starting with Mars, was not circular, but elliptical in form, and discovered two other things. This whole business about assuming that this is the actu-

al surface, on which events are occurring—that goes out the window.

Why? Well, he discovered, in the elliptical function, that the Sun was located at one of the two foci of the relevant ellipse. And he also discovered that the rate of the planet's motion, along the elliptical pathway, was *constantly non-uniform*. And what the measurement was. That proved that there was an operating physical principle, invisible to the senses, but whose effect was, nonetheless, visible to the senses. And therefore, you can not simply say, that, from Euclidean geometry, from looking at the universe from the standpoint of Euclidean geometry, you can come up with a mathematical description of the laws of the universe. That's what he proved, among other things—as others had proved before him.

### The 'Shadow' of the Universe

Now, what does that mean? That means, essentially, that you have a real universe, whose shadow is the universe you think you're seeing. In other words, if you're looking at this spherical sensorium up there, which you imagine you're inside it; you're looking up at it, like the ceiling of the universe; and you think, that the mathematical relationships between the events you're observing, as on that sensorium, are reality.

They're not. But, there is *some* reality to them, isn't there?

What is the reality, which they correspond to? Well, think of them as the *shadows* of something projected upon the sensorium *from outside* that universe. Think of that universe, the one you *think* you're observing, as an imaginary universe—one created by the senses, as an artificial sense, of what you're actually experiencing, but an image which is determined by the way your sense organs are constructed. Now, what is the *real* process, which is causing this effect in your sense organs? Well, that's what Kepler's law meant, Kepler's law of gravitation.

Now, how does this reflect itself? It reflects itself, that the planet is now moving—like Mars—it's moving along the elliptical orbit it follows. At every point you observe it, no matter how finely you divide the points, the rate of motion is changing, relative to sense perception. So, what is regular? What is constant? Well, at every point, on this pathway, you're dealing with a different curvature, which is intersecting the curvature of some elliptical pathway, as if it were touching it at that point. Call it a "singularity"—the intersection of the curvature of the *real* action, as against the *imagined* curvature, which is a shadow of the effect.

Now, to understand the universe, you have to understand the relationship between the two curvatures. The curvature of the function, which is defined by the tangent action, or tangential interference at that point; and the motion within the orbital pathway, as a different surface. The two surfaces give you a sense of mapping of the universe. Now, obviously, the universe is much more complicated then, isn't it? It's more complicated, because you have to look at *all* the curvatures, to see what is really happening in the universe. And you come up with a different kind of universe.

Now, we also have a second thing going on: We have man *in* the universe. To the best of our knowledge, the number of physical principles, in the universe, as a whole, is predetermined. That is, we don't determine the number of principles that *exist* in the universe. We *discover* them, but we don't *predetermine* their existence. But, we're not aware of their existence, until we make the discovery.

All right, therefore, you have a sense of two universes—or maybe three: One is the sense-perception universe, which is only a shadow, as, for example, Plato defines it; then, you have a universe as *you know it*, in terms of principles; but then, there's a *larger* universe, which includes what you know, and what you have yet to discover, which is the real universe. What happens, therefore, when man discovers a principle? Well, man's discovery of a principle, is not simply a matter of observation: It's a matter of *intervention*. Of willful intervention in the universe. When man, who is a creature of *will*, discovers a physical principle, and *uses it*, even though the principle discovered already existed, *man changes the order of effects in the universe*.

So, therefore, we have three universes to consider: the totally imaginary, shadow universe of observation, sense perception; the universe, as we know it, in terms of physical principles, which is good, it's real; whereas the shadow universe is merely a shadow universe, but, it is not complete. We have not yet discovered the universe in full. So, there we are: We say, the process now is determined by man's discovery, and efficient use of, discovered universal physical principles. Ah!

#### A Riemannian Surface

How do we measure the effect of adding a new physical principle, as a discovery, to the repertoire we already had? In Gauss's measurements, or in Riemann's work in general, it's defining what's called a "Riemann surface." A Riemann surface is typical of the case, where you have the intersection of one universe, with the tangential impact of another universe upon it—typical Riemannian surface. In this case, you say, you measure the change in effective action within the universe, as a result of adding the action of this additional physical principle that we discovered.

What that means, of course, in practice is, that relative to man, man's power over the universe increases. This power is expressed in various ways, but it's also expressed very simply in *quickness*. When man discovers new physical principles, and applies them efficiently, the quickness with which man can effect changes in the universe, is increased.

Now, if the quickness of a standard event is changed, if the measuring rod of

time is changed, in terms of practice, then there is no such thing as *universal, fixed, permanent clock-time*. The universe does not go "tick-tock." The universe speeds up. It speeds up, because of the effects of the processes of principles. It speeds up, because man's intervention, with new physical principles, *speeds up the effective measurement of time*. That is, time tends to speed up; time becomes quicker.

So, the idea that people can take a fixed clock-time measurement, and apply that to the universe, and tell me what the actual history of the universe was *relative to man*—they don't know what they're talking about. They may be very good astronomers. They may be good scientists in general, but they still don't know what they're talking about.

So, that's what the anomaly is: that time is not an absolute clock-time, functioning independent of the physical changes in the universe. Time is a reflection of a *direction* and of *relative power* of the processes we're deploying, relative to the universe and relative to man's actions. So, time is essentially, intrinsically, relative. It is not absolute, in the sense of "tick-tock."

## What Is a Thought?

**Question: I was thinking, about thinking, you know: What is thought? Is it a creative form? Are there forms of thought, like, maybe, when I have a conception of something, it's not in the form of language? I'm not thinking in a thought—well, I don't know if the thought is the idea; or, if the thought is the communication through the language of the thought that is produced, so—**

*LaRouche:* Well, that's not such a big problem. It's a big challenge, but it's not formally a big problem. The problem is, that society today is so full of all these assumptions, which people are taught to believe, or induced to believe, that what they ought to recognize at first-hand is blocked by the secretion of all of these assumptions.

You're talking about speaking, as communicating. Talk about music, as a form of communication: What's the purpose of it? The purpose is communication. What do you mean by communication? Well, let's take *human* communication. You have two levels of communication: You





Chris Lewis/EIRNS

Discussion with LaRouche at an East Coast cadre school in November 2002.

have animal communication among human beings—you know, “pass the salt,” for example; that’s animal communication. Then you have human communication, which involves ideas, that is, ideas which exist—they’re real; or they’re conjecturably, possibly real, but their existence lies outside the domain of sense perception, and they can be *known* to sense perception, only as shadows, cast by reality upon sense perception.

So therefore, you’re trying to express a relationship, between a sense-perceptual frame of reference, and an idea. And the function of language is to communicate the *idea*, by the way you refer to the sense-perceptual reference.

Now, what you do, is a sense of irony. For example, let’s take the simple case of the stage: You have the use by Shakespeare of the soliloquy. You have the actors on stage; they’re acting. They’re acting out a part. They’re within a context, which is a play. Then you have the soliloquy, which is performed by the actor, who turns from his role *inside* the play, the context—he turns toward the audience, and he delivers a commentary upon what is going on in the play, or something relevant to it, *to the audience*.

So, you see the principle of communication is thus illustrated: It’s the relationship between the physical referent, and an idea, which is totally offstage, from a

sensual standpoint.

So therefore, the question of speech, the question of music, is how to deliver *ideas*, whose existence is, in a sense, offstage, by means of the way in which you use the stage. So, speech, and music in its literal form, are a stage. Painting, in its literal form, is a stage. The function of Classical composition, whether speech, or drama, or poetry, or painting, is to present ideas, which exist offstage, off the stage of sense perception, and the language which pertains to sense perception.

This involves irony. One of the aids in speaking, as in singing, for the use of irony, has to do with musicality. The *bel canto* trained singing voice, that is, a voice, which has been trained to sing, and to speak, in the Florentine *bel canto* mode, is expressing a natural, physiological potentiality of the human speaking-singing apparatus. And there is no difference, between the speaking and singing apparatus, in terms of this characteristic.

Now, this gives you register shifts; it gives you difference in registration; it gives you differences in coloration, and all devices of color. And every device that exists in music, in song, exists in speech. Ancient Classical poetry is an example of this: Ancient Classical poetry is based essentially upon the use of what is otherwise known, in modern times, as the “Florentine *bel canto* principle,” principle

of speech, to sing poetry. And the Classical poetry is used in that form. The remarkable thing about Classical poetry, as we’ve looked at some of these things, with the aid of some experts in India, on the question of the ancient Vedic Sanskrit poems, is that, some of these poems, for example, contain precise astronomical information. Some of this astronomical information, calendar information, is embedded in this poetry.

The people who have transmitted this poetry by oral tradition, in the lack of a written communication, by oral tradition, are able to transmit this over many successive generations with great fidelity—that is, with a minimal amount of error. And the convergence of all the people who repeat these little hymns, is such that, the culture

replicates the hymns.

In many cases, the person who is reciting Sanskrit, or Vedic—chanters, do not know the language in which they’re reciting. But, nonetheless, they’re able to communicate these hymns, with relatively great fidelity. And thus, the poetic form, as a Classical poem, as known to the Vedic or Sanskrit, is thus shown to be a *medium of communication, in its own right*, which is much more reliable than what we would call “prose speech utterance” today.

And thus, the use of musicality in speech, as in singing, is an essential part of the process of communicating ideas. The significance of this shows *in irony*. Not only metaphor, as such, but irony more generally. You convey a meaning, by a matter of intonation, in such a way, that you convey different levels of *irony*. The *idea*, which is always a tension between the sense-perceptual reference, and the idea which exists beyond sense-perceptual reference, is like the actor speaking offstage; also, at another moment, speaking *onstage*. And therefore, the distinction between the two, enables the human being to communicate ideas offstage—that is, relevant to *ideas* which exist in the domain beyond sense perception, but are using a language, which, in its obvious function, is designed essentially to communicate

references to sense perception.

Sometimes, “pass the salt” can be a statement, which is a poetic idea. Sometimes, it’s just saying, “pass the salt.”

## Man Is Intrinsicly Good

**Question: I have a lot of problems with the statements you’re making. [This refers to LaRouche’s comments on the necessity for infrastructure development.] First of all, I agree that the interior continents must be developed, but if we tried to do the Eurasian Land-Bridge today, we’d have it administered by corrupt Western and Japanese businessmen, Middle Eastern Wahabis, Central Asian warlords, corrupt Chinese bureaucrats, and the Russian mafia. Each would take the resources entrusted to him, for the development of the Land-Bridge, and use it to line his own pockets.**

**Second, you equate budget cuts with genocide. That assumes that the increase in government spending during the ‘90s actually saved lives. Which of course is not true. Most government spending today is wasteful, and should be cut. Your fallacies, Mr. LaRouche, spring from your failure to apprehend the real problem, the sin enthroned in every human heart, and the only solution: personal faith in the blood of Jesus, shed to atone for our sins.**

*LaRouche:* Well, actually, you can’t complain about the morals of other countries, because the worst morals I know in the world are found in the United States, in the U.S. government. And it is not—it was *misspending*, not excessive spending that was the problem. That’s not the problem. The problem was, not enough spending in the right way, and raising prices without producing goods.

And these other countries do not have as much corruption as we have. They don’t have the luxury of being quite as corrupt. So, we’re in a sense better off with them, than otherwise.

Besides, man is not naturally evil. That’s a wrong conception. Man is not intrinsically evil. Man is intrinsically good. However, there’s a little problem here, of getting a person from a new-born condition, into realization of their true

human potential. And so far, in society, very few people really make it. But I know, from long experience, that if you do as I do, and accept the frustration that that incurs, sometimes, you appeal to that within people which is good, naturally good, it’s the best thing in the universe.

And this idea that Christianity deals with man as being intrinsically evil—that is a false belief, which has nothing to do with Christ; has nothing to do with Christianity, the conception of Christ. Just think about the ludicrousness of this argument, about this: Christ came to rescue the evil. This is a Jonathan Edwards-type of crazy idea, which spread among some Protestant cults, and others. You’re saying that God, the Creator of the universe, has bad taste, that he would send His Son to die, for a bunch of creatures which are the lousiest, most evil things slithering across the planet. I would propose to you that God does not have bad taste. And that Christ’s sacrifice for the redemption of mankind as a whole, expresses God’s confidence in the essential goodness of the human individual.

And as Christ and many of the apostles, and others, sacrificed their lives, willingly—not that they desired to sacrifice their lives, but they did it when they had to—*did* it in order to, on behalf, of that intrinsic goodness, which lurks in all mankind.

Our job is to bring forth in man, to inspire them to recognize that goodness. And to recognize it in themselves, and to cling to it, and not to slip into some kind of degenerate kind of behavior, which is typical of people today, including many so-called fundamentalists.

A fundamentalist, for example, who supports a John McCain or a Lieberman, or some of these crazy cults that support George Bush, is actually doing evil. Now, how can they say that their kind of Christianity is what I should listen to, when what I see them doing *is* evil? Whereas I know that mankind, who often does commit evil, is intrinsically good, and that God, through Christ, in particular, has expressed his confidence in the essential goodness of mankind.

And it’s my job, as anyone else who follows that, is to bring forth in people, to the degree possible, the essential goodness which lives within them—not to write them off, assuming that if they get down and crawl, and say what a

dirty little boy they are before the altar, at an altar call—I don’t have any confidence in altar calls. I’ve seen many of them, and I don’t believe them. An altar call is a habit which is expressed by an inveterate sinner, who has an altar call, and then goes out and commits a sin, and then has another altar call. And I haven’t seen it doing much good lately.

Particularly in the case of the President of the United States, who has two defects: One defect is his former drug habit; the other is, he got off the drugs in the way—through one of these fundamentalist things—which turned him into a beast. And that’s the problem.

We have to believe, if you want to defend Christianity, you have to believe in the essential goodness of man. You have to believe in the redemption of mankind. You have to believe in the cause of trying to get other people to participate in that process of redemption of mankind, not out of fear, not out of hate, not out of combat against evil as such. You want to fight evil? Fight Bush. But in the sense of the goodness, that you have one life, and don’t waste it. Spend it wisely. Spend it, to do good.

And most of humanity is like that. They’re reachable. It’s *our* job—especially those who become leaders—it’s our job, constantly to reach, to bring forth the goodness, which is innate to all people.

## Most Education Today Is Pretty Bad

**Question: As a brand-new organizer, I’m having some trouble managing my studies, having so many areas to study: economics, mathematics, philosophy, etc., which are all interrelated, I find myself jumping around a lot, and basically wasting my spare hours or days to study, because I’m skimming over a lot of topics. And, those hours are pretty precious, as a full-time organizer. So, I guess I’m asking for your advice, which is: Where do you think the best place is to start? And why?**

**And, I also have a second part, because I’m obviously finding that most so-called “historical” accounts, are nothing more than propaganda and fallacy, so I’m looking to find a way to research the true history of my Irish and**



EIRNS

*A geometry pedagogical with the LaRouche Youth Movement in Lima, Peru.*

### **Celtic roots, for an historic account of the relationship between religion and the peoples who created them.**

*LaRouche:* Oh! This is fun. Well, of course, there may be some cross there, because, you know Classical Greek was the language of Christianity; it was the language of St. Paul and John, for example—the Gospel of John—which, in a sense, touched the influence of people like Cicero, in ancient Rome. And, of course, affected strongly Augustinus and others. And, from thence, Christianity and that Classical Greek tradition in Christianity, was passed to Isidore of Seville, and it made its way up to Ireland, of all places. And the Irish were the only Christians in sight!

And, the Irish then Christianized the Saxons. And, as I've said, the Saxons, in turn, returned the favor by Christianizing the court of Charlemagne. But, then the Normans came in, and they slaughtered the Saxons, and there's not been a Christian seen in England since—at least that's the Irish version of the story.

This, I think, is the reality of it—is to look at this question of Irish and Classical Greek—it's ideas. Ideas. And, of course, in the Irish, you're looking at the poetry and things like that—the legends and so forth. But of course, there was the Norman influence there, too, so you've got to take into account, the Normans did conquer Ireland, and ruled it for some period of time.

On the other thing—how to organize conflicting studies: My view is, from

experience with this sort of thing, reflecting upon my life's experience with it, would be, that you have to have an independent standpoint—independent of any of the subjects as such, or as classroom subjects—and you have to sort of “look down” on them from this pinnacle, or observation point, which lies above them. Then, you are the master of the experience of the studies, rather than you being a person, buffeted from one island in the sea of this or that, to another. The problem is, when you're buffeted about.

And, most education today, in most universities and schools, is pretty bad. It's gotten much worse, as I've observed over the recent generations. I thought it was bad, when I went there—but, it's much worse today. So, really, you have a problem; you have a cultural problem in society, in which it's working.

So therefore, you have to have an independent standpoint, a sense of personal identity and knowledge, which stands above and outside the confines of any of the subjects as taught. Then, you look at each of the subjects as taught, *clinically*, as an observer of those subjects, from the standpoint of where you find your own identity. It's the only way to deal with this. What I've done, and developed over the course of my life, I quickly developed *my* point of view, *my* sense of personal identity, as opposed to my exposure to this horrible thing, called the education to which I'm being subjected.

## **How Do You Use Your Emotions?**

**Question:** Hello Mr. LaRouche. I have a question on the fact that the survival of civilization has always depended on Renaissance thinkers, thinking outside sense perception and popular opinion. But, if you're going to be a Renaissance thinker, you have to be equipped with reason, and not be emotional. And so, what our parents bestowed upon us, is that it's okay to be emotional, it's okay to act on your emotions, and do whatever you feel like doing.

**So, my question is, how do you use and develop your emotions as a useful instrument in this mission, since the world depends right now, on your organization, on our Youth Movement, and how to get this Youth Movement to not act on emotions, when small things come up, but to see ourselves as sovereign individuals and be of use to mankind?**

*LaRouche:* Well, this power to deal with these kinds of problems, was addressed by Classical art. Now Classical art is not something that somebody invented. Classical art is actually a sort of secretion of the human being, a natural secretion.

Any paradox in life, whether the paradox of sense perception, where you find that, in some moment, things don't work the way you would have thought they would from habits. And you realize there's something out there, besides what your sense perceptions tell you. At that point, you suddenly have a sense of *irony*—about metaphor, of irony. Now this means that, the most important experiences in life, are of this type. Things that evoke a sense of irony and metaphor, that the world is not what habit instructs you to believe it was. That's the message you find important to communicate.

These things are called *ideas*—genuine ideas; artistic ideas. So man tries to develop ways of communicating things which obviously are important to society, and to the individual and to others. Out of this comes art. It comes in the form of Classical poetry, which is an

evolution of a combination of the natural qualities of the human speaking-singing voice, which has natural peculiarities. Which are used, as a way of communicating, in composing poetry. This is true in music. It's true also in painting, great painting, great art.

Why would a Greek spend so much time discovering what was implicitly the catenary principle, in order to get out of tombstone carvings—as a kind of sculpture—into a kind of sculpture, which *captures a moment*, a frozen moment of actual motion, as the great Classical Greek sculpture does. Or, the great paintings, for example, of Leonardo da Vinci, where this principle is explicitly developed by him, as this new conception of perspective, in the later period of his work as an artist.

So, this irony, this need to communicate *important* ideas, as opposed to simple, animal-like experiences causes mankind to concentrate on this kind of question, and this kind of *experience*, which is important to governing civilization.

Now therefore, the person who is a slave or a serf, who is trained *never* to do anything different than he's been trained to do, he's not supposed to change. He's not supposed to change what he does. He's supposed to do it! Like any good animal, who gets into the stall in time, at night, and out in the field in the day, when ordered to do so. And, to the slaughterhouse, too, when desired. So, that kind of person will trod along through life, never changing, and walk all the way into the slaughterhouse, screaming at the end, but not knowing why they got there.

Whereas the person who's alert, who develops ideas from experience, from ironies, *realizes* that the process of behavior, of society *must be constantly changing*. There are discoveries constantly being made, which must be shared, by aid of Classical art. And that's it.

Now, what happens, when we come to great crises, like the one now, and people are finding out that, it's going deeper than might be apparent from the news reporting; they're finding out the system's com-



Samuel P. Dixon/EIRNS

LaRouche giving the keynote address at a cadre school in California, August 2002.

ing apart and dying. Who believes that the market is going up? Who believes that? Maybe a few idiots, who are brainwashed into believing that they have overheard saying that. But everybody knows things are collapsing. Any ordinary person out there knows that.

So, now we're in a period of crisis. And, the apparent thing is: *We cannot continue to do what we have been doing*. So, up to that point of perception of a crisis, many people, because they have *not* been well-developed, in Classical culture and so forth, science, have been content to go along and get by in life; especially as you get older, when you get into middle age, you say: "I don't want to change my habits. I don't want to change. Don't try to change me. I'm going to be like this always." And they go on, stumbling along, through life, with habits they've already acquired—and a few picked up, here and there, added. But no sense of change. Then, you get to a period of crisis, and the population is *stimulated* to realize, that nothing is working! And suddenly, they begin to look for ideas, which take them outside pre-established habits.

That's the way it works. That's where we are now. The problem is, in doing what we're doing, is that we ourselves have to supply the ideas, which these people need. And therefore, we have to

have an impassioned concern, for trying to recognize what their problem is; what is the thing they don't understand? What is it that confuses them? What are they anxious about, in terms of ideas? Is there a solution? And trying to put them through the experience, of discovering for themselves, what the ideas are that are relevant, and what the solution might be.

That's our job. And, it really is the same thing, as great Classical art. And it's something we should have *learned*, if we had been more generously exposed to a tradition of great Classical art, already.

## Gauss's Mathematics Vs. Newton

**Question: Hi Lyn. This is Ian in Seattle. And I have a question about the mathematics of Gauss. I've read a little bit of what you've written on him, as far as the teachings of Gauss and Riemann and Leibniz, contrasting those of Euler and Lagrange and Newton. I was wondering if you could contrast those for me, so that I can maybe understand why the one, Gauss's teachings are so much more important, than the others? And what so specifically had gone wrong with Newton, Euler, et al.?**

*LaRouche:* Well, first of all, the root of this thing, is empiricism. Empiricism was

invented by Paolo Sarpi, the tyrant of Venice, from the latter part to the last two decades of the 16th Century and the first decades of the 17th Century. Paolo Sarpi, among others, had a great influence on, to some degree, France; but, especially on England, where his influence is most notorious, upon Francis Bacon and Thomas Hobbes.

Sarpi was most famous through a student of his, who was also a household lackey of his: Galileo Galilei, who was quite a faker in his own right, who was the teacher of mathematics and so forth, to Thomas Hobbes.

Now, the purpose of this teaching, was that Paolo Sarpi explained it as being based on the doctrines of a fellow called William of Ockham. And so, it was the so-called Ockham's Razor, was stripping out from science and knowledge, all those things which pertained to principle. Eliminate all principles, and substitute, instead, a set of so-called "reductionist" axioms and postulates and definitions. And allow nothing.

All right, now the effect of this, was to reduce knowledge to a *statistical* interpretation of sense perception. Now, I had earlier, the second question that I received this morning, there, from Seattle, was on this question about curvature. Now, imagine that, here you have the spherical sensorium of the observation of the heavens, of the night sky. And, imagine that you can see nothing but those points, as such. You now run a statistical interpretation of those points, which you see displayed, as events, or singularities, on the sensorium of this oval, this sphere, in which you're contained. Then, you are in the realm of empiricism.

Whereas science is based on rejecting that. Remember, now, before all these crap artists came along, you had the case of Kepler, among others; you had Leonardo da Vinci, before Kepler; you had Nicholas of Cusa, before Leonardo; you had Brunelleschi in the same period as Cusa. So, science was already developed! You had the principle of least action, as discovered by Fermat, in his work. You had the work of Pascal.

Along, in the middle of this, comes Descartes, comes all these things—this Cartesian model, which was used for Newton. And, Newton was a plagiarist. Newton's work on astronomy was all fake. He plagiarized an English transla-

tion, essentially—an English publication, of Kepler's *New Astronomy*, with the assistance of some people who worked with him. And, then he faked the results. And that became known as the Newtonian system.

So, what the problem here is, that these guys were all involved in faking! What's the effect of the faking? If you have a society, in which some faking is not allowed, in which people are actually discovering universal principles, experimentally, proving them, then you have a society in which the individual member of society knows what it means to discover a principle, which lies outside naive sense impression; does not rely upon statistics, but relies upon the experimental ability to *demonstrate the efficiency of the principle discovered*. Then, you have a society, which is progressive.

Now, if you have a society, which is not so trained, then what do you have? You have a bunch of dumb sheep: who will do as they're told, follow orders, know nothing better, and just do it, like human cattle. The objective of this process, is to produce human cattle.

Now, in the case of Euler and Lagrange: Euler was not stupid, but he was a fanatic. Newton was probably not too intelligent, actually. He specialized in black magic. But, Euler was a very skilled, very intelligent mathematician, from a *formal* standpoint; from tricks with arithmetic—for example, his discovery for the mathematical model for the knights' moves in chess is famous. But, he was evil. It wasn't that he was stupid, he was evil. And he *deliberately* created a fakery on the question of the complex domain. Euler's student, his protégé, who succeeded, and then later went to become the protégé of Napoleon Bonaparte, faked it also.

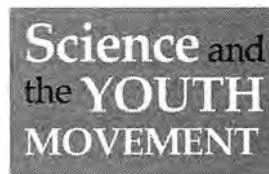
#### Gauss Exposes the Fakers

So, Gauss simply made a demonstration from the standpoint of simple proof, that this was fake—it's fake. And that's what Gauss proves; he proves that it's fake; that these guys are fakers. And, by doing so, demonstrates what I said in answer to the first question today, from Seattle: That we actually live, not in a sensorium, which is some kind of a big sphere—we're looking at the dots, the lights on the points of the sphere. But, rather, what we see of these events, as singularities, are actually tangential

points, of intersection of a *real* process, with the imaginary process, which is the spherical system.

And, by studying the curvature of patterns of certain events—Gauss used three, to demonstrate the orbit of Ceres—by taking a pattern of several of these events, and discovering the curvature, of the tangency, associated with the observation of those events, he now discovers the real universe.

So, the complex domain, actually pertains to this concept of the universe of *reality*, which lies outside the simple sensorium. So therefore, you have what we call "the complex domain." And Gauss's essential discovery was to prove, by these and related works, and by his work in astronomy, to *prove* the principle of the complex domain, on which all competent modern physical science is based. Anything contrary, is incompetent.



## A Method of Truth

**Question: Hi, this is Tirana, and I wanted to ask you: You speak a lot about the difference between truth and opinion, and even say you've touched a lot on the progression of principles in human history. And, I wanted to ask you, when you are approaching studying history, and studying actually what happened, history is easily manipulated. And, I was wondering how do you approach that, or develop a method of truth for actually knowing what's going on in history, so that you can make a link between the Straussian roots of the Chickenhawks, and things like that? I'm wondering how you approach it?**

*LaRouche:* Once you accept the fact, that human knowledge is of this form of discovery of universal principles, for example, when I was walked into my first class in geometry in secondary school, I was against it, from the start. Because it was obvious to me, that from the first days in the class of that course, that it was based on a fraudulent assumption. It was based on the assumption, that you could have a scheme of geometry, which ignored *physical reality*. For example—well, I won't go into that; I've

talked about that a number of times.

But anyway, so the point was, once you look at reality from the standpoint of the nature of man, as being unlike an animal, man's ability to discover principles, which we can prove are physically efficient, which exist *outside* the domain of sense perception, but by knowing these principles, we then control the way we act, in a way to change the world of sense perception. Now, that's reflected, of course, by man's ability to increase our potential population-density, from an ape-like level of several million individuals, to billions now.

So, history, therefore, is a determination of the progress of man, and man's ability to survive *in* the universe, and to discover what the *physical* actions are, and the kind of social relations, which were essential to that progress. That, to me, is history.

That, I think, was the actual ancient root of history, with what we know of Thales, and what we know of Pythagoras, and that school and so forth, which I think is made clear to us by Plato.

Most people who've studied history competently, work from a sense of Plato's dialogues—that is, in modern European civilization—and therefore, the concept of history comes to us largely from Classical Greece, as in Thucydides, for example; *The Peloponnesian Wars*, is an example of this. But, actually, then looked at, from the standpoint of *modern* scientific cultures, which give us the ability to compare man's *physical* mastery of the universe, with man's mastery of the challenge of the social processes, with which that occurs.

---

Feb. 1, 2003, by telephone to East and West Coast cadre schools

---

## Nuclear vs. Solar Power

**Question: This is John from the Los Angeles region. My question is, why should we have nuclear power, versus solar power, and how exactly the gang-counter-gang operations work, with a lot of these modern leftist movements? So, that's my question.**

*LaRouche:* Okay. Because solar power is idiocy. Actually, solar power is nuclear power. Where do you think you get solar power? From nuclear fission and fusion, in the sun.

You want to eliminate nuclear power? No solar power.

Also, this whole idea of energy is crazy. You know, I believe in Don Quixote when it comes to windmills. We need Don Quixote now, for a useful mission! He's an important character of fiction, but now he can be an important character of reality. He can get out there with his lance, and knock some of these things down, and get this ugliness off the landscape, eh? These ugly things, these monsters up there, sitting up there snarling, killing birds. They kill birds! Bird-haters! [laughter]

Now, the point is. . . Now, this goes back to a piece of scientific idiocy, which was understood already—the problem was understood by Plato, already. The concept of *power*, as opposed to that idiot Aristotle's concept of energy. So, when people talk to you about nuclear energy, or solar energy, they're Aristotelian idiots, who shouldn't be talking. They should be monkeys, and not talk. They can chatter, but not talk.

Because, the issue here is power.

Now, power is reflected in various ways in terms of energy, relative to what people call energy. Power has two features, generally, descriptively, in the form of energy. This is not where power comes from, but this is what power reflects, in terms of energy language. One, is energy flux density. What is the *intensity* of energy, apparent energy, per square kilometer, cross section area of motion? It's called energy flux density.

Now, compare the energy flux densities of various modes of power generation. Solar power is the least efficient. As a matter of fact, the use of solar power is insane. Because solar power has a very important use on this planet: Light, light. What we want is more vegetables. We want more foliage. We want the deserts to bloom. What we want to do, is we want to get areas which are too hot, to cool down. We want more moderate weather. We want to turn the deserts into areas where people can live, under normal conditions.

How do we do that? We increase the biomass. Increase the amount of growth.

Now, for example, trees will absorb about 10 percent of the solar radiation hitting the Earth's surface. It's very good. Take 10 percent of the solar energy, in a certain area; convert it into trees. You

moderate the climate, both for winter and summer. You take an area which is a quasi-desert area, or desiccated area, and you convert it into a place where people can live. You convert areas which are useless, into areas where you grow food. So therefore, we want to manage what we're getting in terms of solar, heat radiation. We want to manage it, for the benefit of living processes on the Earth, including man.

For example. If we plant enough trees in the high plateau, or relatively high plateau, of southern India, we would probably lower the average temperature in the summer time, by 5 to 10 degrees. They need trees. Mrs. Gandhi had a program for putting in these semi-hybrid mango trees, and they're planting them all over the place, developed at the Delhi Agricultural Institute of India.

You know, the Indian people—I don't know if you know what mangoes are, really know what they are—but when the mango crop harvests in India, everybody shuts down, and they'll take all the mangoes in sight, and if they've got a bathtub, they fill a bathtub with water, get naked, get in the bathtub with the mangoes, and eat. Because a ripe mango is a very popular thing. This is particularly true in Bengal.

But, a mango would be treated by the Indian farm family, as a family heritage. The tree comes, these special trees, come to fruit in three years. And then they fruit every year. And the fruit is delicious. So obviously, if you give a farmer help in planting these trees, and maintaining them, the farmer's family is going to protect those trees, and they will be assigned to the children to maintain them. Because these trees are now a family heritage. of something they *like*. They're not going to chop those trees down for firewood, as they did before—what happened in turning the Deccan area into a semi-desert.

### Enhance the Biosphere

So, we've got our Western land. You've got the great American desert. Look at southern California. Look at what's happened to the aquifers. This is insane! Look at Northern Mexico; what we're letting happen there is insane. The conflict between Texas and Northern Mexico over water, is *insane!* And therefore the thing with the solar radiation, is to organize its use, in such a way, as to

enhance the biosphere. Be kind to Mother Nature. Enhance the biosphere. Don't waste solar energy, trying to power television sets.

All right. Now, therefore, the other aspect is, that if we use. . . . We waste a lot of money, by taking gasoline as a fuel all over the landscape. This is insane! Why should we do that? We don't need to have gasoline as a fuel, or diesel oil as a fuel. We don't need that. If we have a high-temperature gas-cooled reactor. . . . Let's take a very specific type of a nuclear reactor. The so-called UNIK model—developed by a friend of ours, who is now deceased, Professor Schulten—which works. This model is a self-regulating reactor, which operates in a range of between 120 and 200 megawatts. That is, as the reactor

idly, and make many of them, in an area? These things are easy to put in. . . they're self-regulating.

Now, but with these kind of reactors, we can turn water into a fuel! Very simply. You use high-temperature reaction to disassociate water, producing a hydrogen, or hydrogen-based fuel. You can use fuel cells, you can use other vehicles, you can convert from the use of gasoline, or diesel fuel—which is a highly inefficient fuel, relatively speaking—to a much more efficient fuel, which is a hydrogen, or hydrogen-based fuel.

So now, instead of carting oil all over the county, with pipelines and natural gas lines and so forth, you use natural gas where you have it in excess, as a chemical feedstock, for fertilizers, things

lot of waste. Boiling oil generates waste. You can't really be too efficient with that. Coal is terribly wasteful. Hauling fuels all over the country is very costly, and very wasteful. Don't do it.

So, why not have a new system, which can generate the fuels where we need them, and have them available on a standard, in every part of the world, or in every part of the United States, in particular.

So, therefore, there is no problem with it. If you're afraid of nuclear energy, die. [laughter] Why? Because you have nuclear reactions going on in your body. Radioactive potassium reactions, which are an essential part of life. You don't like radioactivity? Don't lean against a brick wall. You'll get more radiation than from a nuclear reactor. A brick wall will do it all by itself.

So, this whole idea. . . . What happened is this, very simply. To sum it up: 1964, there was an attempt to turn the United States from being the great producer nation of the world, per capita, per square kilometer, into a parasitical consumer society, which would live by sucking the blood of other parts of the world, and destroying our own people, and turning them into a bunch of dummies, which has been done with our education system now. So, as a part of that, they attacked technology.

Now, the first attack was not on nuclear energy. The attack on nuclear energy happened after 1972. But the rock-drug-sex-counterculture, a key part, a leading edge of the campus radical movement of the mid-to late 1960s, was essentially based on "end of technology": "Destroy technology. Go to a consumer society." Which means a parasitical society, like the Roman Empire. And the attack on nuclear energy, was determined to stop progress.

Take the other case, the case of DDT. There was never any reason to ban DDT. The campaign against DDT was a complete fraud. People are dying today, because DDT was banned. It was one of the most efficient, most harmless types of insecticide available. You have people dying of West Nile virus, because of a lack of DDT. This was done to stop technology. It was done as part of the war against technology, to transform us from a producer nation, into an imperial consumer society, a predator preying



Brendon Barnett/EIRNS

*Elkee Spies, Ryan Eleck, and Sylvia Spaniolo work with Platonic solids to construct the Moon model of the nucleus, at a Los Angeles Cadre School, April 2003.*

becomes hotter, it tends to shut down the rate of reaction. So, it keeps the rate of reaction within a certain range.

With a high-temperature gas-cooled reactor, you can generate in an area, or say, a complex of them. . . . Instead of putting up a 1.2 gigawatt reactor, you put up a bunch of 200 megawatt reactors, and you put them up quicker. Because the big thing about the large reactors is, you have to pour concrete, and you have to cure the concrete. So, therefore it will take you many years, up to 5 to 6 years, to complete the reactor, and you have to spend and invest all the capital in it. Why not build smaller reactors, which you can complete more rap-

like that. You take petroleum, and you shift the use of petroleum to chemical feedstocks, which is what it's most useful for. Burning petroleum is very inefficient. Use it as a chemical feedstock, the benefit to humanity is much greater per ton consumed.

You would turn the Middle East into production, a chemical factory, to produce feedstock, which would be used by the world, rather than burning the stuff up, and polluting the atmosphere. Much better. Then you would produce the hydrogen-based fuels, in your local region, so you wouldn't be carting this stuff all over the place. The problem with other methods, is, they generate a

upon the rest of the world.

And therefore, this campaign against nuclear energy, was a massive campaign of brainwashing. And someone who's afraid of nuclear energy, and prefers solar or something, they have to be a brainwashed zombie. And they should be told that. Because only by knowing they're brainwashed zombies, can they free themselves of the slavery.

## What Is Evil?

**Question: How are you doing, Lyn. This is Delante, from the Baltimore-Washington region. This might be riding off what you addressed for Rob, but I think most of us are here to change the conditions of this world; and, throughout history, you have dark ages and renaissances, and revolutions that are created by youth movements. And, as we say that empires always fall, however, even in periods of history where the course of civilization had a high potential of discovering truth, they've also fallen backwards as well.**

**At one of our East Coast Monday night meetings, we were discussing the potential of destroying the intentions of evil, in its entirety, and having a perpetual revolution. Which gets to the question of, what is evil? Can you address that?**

**And also, as a bonus, I would love to hear from you on the question of making spiritual exercises.**

*LaRouche:* That's why I've treated Plato as spiritual exercises, and why I started from this Gauss example. Because the Gauss problem in 1799 goes directly to it. It goes to it in two ways: It goes to it, because it deals, identifies as the target of Gauss's attacks, a method expressed by, especially d'Alembert, Euler, and Lagrange, *which is the essence of evil*, as we experience evil in modern science, as empiricism; as the denial of the existence of the *human*, in knowledge, by insisting that everything is mechanistically more or less determined, as reductionists define it.

Now, the other reason I use that, is because it refers to a previous state of society, that is in pre-Euclidean Greece, in which the Pythagoreans and others, especially as indicated by Plato, demonstrate exactly the same principle, which Gauss addresses positively, in his attack on

d'Alembert, Euler and Lagrange: That is, the principle of cognition. Or, what becomes in mathematics, the principle of the complex domain. This is already fully understood, in a different frame of reference, that of constructive geometry, by the Pythagoreans, Plato, and so forth. Contrary to Euclid, contrary to all the formalists.

So, what's happened in modern society: We have changed, under the influence of empiricism and related kinds of reductionist belief, into a degenerate culture, including mathematical-physical culture, which is degenerate, in the by and large.

There are a few exceptions here and there, and they're very important to us. But, my concern, also, is to use that, is to say, "Look, there is no difference, in terms of knowledge, in terms of the nature of man, between physical science, properly defined, and Classical art, as properly defined. There is no duality, between science and culture, as it's commonly put—doesn't exist. If you say, "Culture exists independently of, and contrary to science," that's not true! Absolutely false. Because the nature of human ideas is the same. Therefore, if you have an idea in culture, it is of the same essential nature, as in physical science.

The only difference is, is in what we call physical science, we're concerned with the treatment of the relationship between the individual mind and nature, outside of man—man's relationship to nature, as seen by the individual member of society. Whereas, in what we call culture, we're dealing with man's relationship to *man*, in society's dealing with what we might call the environment.

So therefore, the questions have a different form, but the notion of the idea is the same. And the notions of the ideas about man's relationship to nature, are, by their nature, transformable into expressions of society's relationship to nature, and of man's natural relationship to man.

So, that's where we stand. Once we have that conception of man, and my belief is that our youth movement can achieve that—that is, not instant knowledge of everything in the universe, but knowledge of *that*, as knowledge, rather than opinion or "repeat after me" sort of opinion. Knowledge of that gives our members, especially our youth, a sense of an independent, personal identity, a

social identity—what is denied most of these youth, and that's what they're clamoring about, is the fact that their parents' generation *accepted* a *degeneration* of the notion of man, as an identity, and imposed that condition upon their children, who are in the 18- to 25-year group now.

What do you have now? As I said, you have the American patchwork family, of the "now" and "no future" generations. How many marriages in the family, or quasi-marriages? How many changes of sex, from time to time? How many step-sisters and step-brothers, in that family relationship? What kind of relationships, wandering in and out of the whole family structure? What changes and conditions of community are occurring in that? What sense of abandonment, or adoption, are involved in that?

So, what you have is the generation of the no-future generation has been subject to economic conditions, to a condition of meaninglessness, to a threatened state of existence, to an impaired sense of identity, in which the young people of that generation *require*, a solid, hard sense of "*this is my personal identity.*" And my intention, my principal intention, with the youth movement *is that*: Is to point to things, which will enable young people, working together and solving their joint problems, as opposed to just their individual problems, to bring their *individual problems* under control, by having a joint experience of the *solution* to the individual problems of each.

## Prostitution in Science

**Question: I have a question about knowing and about learning [the more education you get], the less creative initiative you have. And, I see that's the case with a lot of people. Some people would just stay in school for their whole lives, or something like that. But, I've worked on various research projects, including, discovering the genetic root of cardiomyopathy and various other things, like researching the nervous system. And, I was wondering why these research programs aren't as effective as they could be; or why you think that the M.D.-Ph.D.s that I work with, don't have the creative ability, so they can come up with the idea of discovering the root of these principles?**





Michelle Rasmussen/EIRNS

*Founding meeting of the Scandinavian chapter of the LaRouche Youth Movement in Copenhagen, December 2002.*

*LaRouche:* This very problem is, of course, one of the contributing reasons why I answered the question, some years ago, at a conference—a side session—on youth organizing, at a conference in Virginia: On what do we do, since the universities stink, how do we get an education? I said: Well, let's start with Gauss in 1799, exposition on the issue of the fundamental theorem of algebra, and proceed from that to history.

The point there, of course, is, that what Gauss did—he did something very important at that point, in this paper: He attacked the two most influential and dangerous mis-leaders in scientific work in that time—Leonhard Euler and Joseph Lagrange. And the curse of science to the present day, is that the ideas, the empiricist system, or its positivist outgrowth, as represented by Euler and Lagrange in that matter, the anti-Leibniz forces of Euler and Lagrange, has been the curse of all scientific work to the present time.

Most scientists, today, even if they're competent in some degree, are fundamentally *incompetent* in the most fundamental principles of science. And, what Gauss does—young Gauss, the student of Abraham Kaestner—attacks d'Alembert, Euler, and Lagrange, on this issue, the basic issue, and defined the complex domain, even though the com-

plex domain was *implicitly* defined before then, even by Kepler, and before Kepler by the Classical Greek geometers. That is, the pre-Euclidean, Classical Greek geometers, typified by the Pythagoreans, and the School of Plato. This is the ancient Classics.

Now, as Plato emphasized, the idea of discovery is based on a very simple, and what should be obvious principle of, among other things, biology. And, if you don't understand this principle, how can you know anything about human biology? What's raised by Plato, is the point that, you do not know the universe, from the experience of your senses. The senses are something, which you get from sense organs, which are part of your biology—just like the sense organs of any dog, any monkey. So, human knowledge is not based on sense perception. That only qualifies you to get you into a zoo cage, as a monkey, or ape.

That, Plato makes the point, and then explains it; he brings it up in the analogy, the heurism in *The Republic*: That what we call sense perception, is a result of biological tissue inside the human body. What we think we sense, with the mind, is not what happened. What we sense, is the effect of something on these sense organs, which radiate, like shadows, something they were stimulated by.

The question is: What is outside your

skin, which tickles your sense organ, which then causes your mind to say, "What is it?" "It's an experience." Yes, the experience is true. But, it's the experience of your sense organ, not the experience of the world outside your skin.

That's the beginning of knowledge. That's the beginning of science.

Now, how do you know, what exists outside your skin? How do you know what exists beyond the scope of what your sense organs reflect to your mind? You have to find an aperture. What is the aperture? The aperture is called "a paradox," an ontological paradox. You find that the sense organ, sense-certainty picture of the shadow, is not consistent. There's something wrong about it; there's an error. And, the case, what we did again; I did yesterday, by aid of the work of Bruce Director, in the presentation on the question of the Kepler's discovery of gravitation. I just touched on one aspect of that. It's much more complicated than that.

But, the aspect is, that Kepler noted, that in the Aristotelian effort to derive physical principles of the universe, from sense-certainty only, as did Copernicus and then Tycho Brahe; in the attempt to do that, they assumed, that simply observing mathematically—shall we say, "statistically"—that a certain regularity of pattern, which means essentially circular motion or linear motion: To assume, that that the principle lay in the regularity of this motion, looked at from the circular or linear standpoint.

Now, what Kepler observed is, that, by more precise normalization of the observations of the Solar System, observed that the orbit of Mars was essentially *elliptic*, *not circular*. Secondly, that the rate of motion, along the pathway, the trajectory of the orbit, was not uniform motion, but was *non-uniform* motion. Also, that the orbit was not around the center of the ellipse, but around one of the two centers of the elliptical point.

Now, therefore, you have the motion conform to one thing. If you take the area from the position of the Sun, to the perimeter of the orbit; and look at the motion a short distance after that; draw another line from the Sun to the perimeter of the orbit. Now, look at the elliptic area, so defined by that measurement. And Kepler determined, that the area, the amount of area subtended by

motion, was always an expression of equal time. That is, that it was equal area, equal time.

Now, this meant that there was a harmonic organization between the two extremes. You have A and B, two points of the ellipse, central points of the ellipse. One of these points, let's call it A, which for us is generally the Winter season, we're the shortest distance from the Sun; then you have from that, to the Summer season, which is the longest distance to the Sun for us, in the Northern Hemisphere.

Now, you take the two areas, and compare them. Harmonically, they define a harmonic relation. And, he later, in his following book, expanded on this, to show that the organization of the Solar System conformed to something which had to do with these harmonic relations;

which Gauss demonstrated, then, at the beginning of the 19th Century, by showing—what happened is, that when Kepler had predicted the existence of a former, disintegrated planet, in an area between Mars and Jupiter—that actually, there was such a disintegrated planet, which is called the Asteroid Belt, which has, harmonically, the characteristics of the missing planet defined by Kepler.

So therefore, you had with Kepler, the definition of a universal principle, what? In which the principle itself, corresponds to nothing which is intrinsically visible. You don't see gravity. You don't touch it. You see the effects. Ah! Sense perception. The sense organs can react to the effects of gravity, but they don't "see" gravity as such.

That's a principle. Science is based on this notion of the Platonic method.

Now, what happens with the case of the empiricists, with both Aristotle earlier, and with the Aristotelian method used by Claudius Ptolemy, by Copernicus, by Tycho Brahe, there is no principle. There is no universal principle. It's all confined within the interpretation of sense certainty, as being the primary reality. Anything outside sense certainty, is some mysterious thing, which has nothing to do with the physical reality. It's out there.



Doug Mayhew/EIRNS

*LaRouche Youth Movement press conference and rally at the State Capitol, Harrisburg, Pennsylvania, addressed by Youth Movement leader Brian McAndrews.*

Whereas, in this case, we see that what is invisible, to the senses, *can be known by the mind*, by examining a paradox, such as the paradoxes addressed by Kepler, in treating the Solar System.

#### **Overthrow-rejection of Aristotelians**

This means an overthrow-rejection of Aristotle. It means the overthrow-rejection of Galileo. It means the overthrow-rejection of *all* the empiricists, including Euler and Lagrange. This is the method, of course—the method of Kepler, is also the method of Leibniz, on a higher level. So, what happened in the 18th Century, the so-called Newtonian faction (Newton was essentially a bum, who stole everything, that he ever discovered; he was half-true, and he couldn't get it right even then); so, the Newtonian faction, typified by Leonhard Euler, and Lagrange—Lagrange was a protégé of Euler—attacked Leibniz by saying, "There is no such thing as this infinitesimal. There's nothing outside regularity!"—outside the regularity of what might be called a "Cartesian manifold." That is, the definitions, axioms, and postulates of a Cartesian manifold.

So, what Gauss attacked them for, was this: That, no: There are principles outside the domain of the Cartesian manifold, which actually control the uni-

verse. And, therefore, you can not derive laws of the universe, physical laws, consistent with a Cartesian manifold. There's a different universe, which is the real universe, whose paradoxes are reflected upon our sense-certainty, which he called the "complex domain." And, it was the denial of the existence of the complex domain, as *real*, by Euler and Lagrange, which is the problem.

Now, this is a problem of *method*. The problem of method is denying the existence of efficient forces, in the universe, reality which exists outside sense-certainty; which we know only by the Platonic method of examining the paradoxes of sense-certainty, and discovering and proving the efficient principles, which cause these aberrations from so-called assumed sense-certainty.

The prevalent method of mathematics and mathematical science, as taught in the English language and other languages, today—the empiricist method, the positivist method—is to assume, that if you have a sufficiently sophisticated mathematics, *you don't need physics*. That everything that happens in the universe, can be derived from a mathematics, based on a certain set of *fixed* definitions, axioms and postulates. The problem is, that the physical scientist,

who does experiments, and does important experimental work, *before* being accredited with this discovery, which may be a genuine discovery, is forced to re-state what he has discovered, in terms defined by Euler, Lagrange, and such successors of Lagrange as Augustin Cauchy, or Clausius, or Boltzmann and so forth.

So therefore, the problem, today, in science, is that the scientist is a prostitute, and there are very few exceptions to it. Every scientist, who does something competent, can get himself certified, or paid, only if he prostitutes himself! He must, having discovered something in one way—validly, by experimental methods—now, has to turn around and prove, that he could have discovered that in a completely different way, consistent with his assumption of sense-certainty. And, it's that *moral* corruption, which pervades in science today, in the teaching of science, which is the source of the problem you referred to.

## How Did You Get Here?

**Question: Hey, Lyn, this is Jason. So, looking back at how the youth movement originally got created, which was you, about 60 to 70 years ago, that was based on, you had read Leibniz, and you, as a young man, attacking Kant based on Leibniz. Now I don't really know exactly what the intention was, what the center was, when the [Baby] Boomers were being organized, back a number of years ago, but now we've got Gauss, and this constructive siege on the Ivory Tower, I was kind of wondering, how we did we get here? How did we wind up, how did you, how did this become the center of things, how did you get here?**

*LaRouche:* It's very simple. It really is awfully simple when you look at it, as I can look at it from the inside.

Very early, I knew that my parents lied. And everybody else lied. It was obvious, you know. You have, company comes—I don't know if you ever had an experience like this, but company comes to visit the parental household. And everybody is very lovey-dovey, a nice conversation—"Oh, we must do this again." And the minute the guests are out of the house, the parents start to gossip about the guests who just left.

You said, "Uh-uh. I got honest parents, huh? Very sincere people."

Then you get into school, you get into classmates, and even as a young child, or playmates, as a young child, and you find they're all lying. Most of the time, they're lying. They're not telling the truth. They're trying to cultivate, they're trying to project other people's opinion of them. They don't care what they are. They're most of the time concerned about what other people, they think, other people think about them. So, they have a very weak sense of inner identity.

Well, I resented that. I didn't like any part of that, and I always got into a lot of trouble. I got whopped on the side of the head frequently on this issue, but I decided I would stick to it. Better to get whopped in the head, than be a person who depends upon reflection as a spectator of himself. Don't make a spectator of yourself, huh?

So, anyway, so I just got into one thing after the other. And when I would get run into something I didn't agree with, didn't believe, I didn't have to disagree with it. If I didn't believe it myself, if I didn't know it myself, I refused to believe it. So I had great troubles with schools, because they kept telling me things I knew were not true, and in later life, I realized I was right most of the time.

But that was easy, because, as I later discovered, they lied most of the time, so it was not difficult for me to make that kind of judgment.

So, I just took a sense of mission, and had that kind of sense.

So, coming into the wartime period, I was in India, in service, coming out of Burma. I sensed a mission. I became involved in the cause of Indian independence. It was a mission. I came back. I found that my fellow soldiers were morally degenerating, under the influence of Trumanism, which was later called McCarthyism. So I first put my bets on Dwight Eisenhower, who I encouraged to run for President. He sent me a nice letter saying why he wouldn't, at that time. But, then I got involved with socialists, because they were the only ones who were fighting McCarthy.

And then, after McCarthy was defeated by Eisenhower, I looked at the socialists, and I said, "What a bunch of dummies! What am I doing here?" And got out of there.

Then came the 1960s, the Missile crisis, the assassination of Kennedy, and the rock-drug-sex counterculture began to run amok, and I decided I had to do something about it. I'd been a management consultant, which I liked doing, because I'm an economist. So, therefore, naturally I liked this stuff, and the clinical aspect of the reality of what goes on in a firm. When people tell me about business, they say they took a course in business, I say: "You don't know anything about it. I was there. And what they tell you about business, is all a big lie. It's much simpler than that. It's more complicated, but it's also simpler."

So then, I decided I had to do something. So, I ended up teaching a course at one location, a one-semester course, and I began doing it elsewhere. In the middle of things that were happening. I knew where the world economy was headed, the U.S. economy was headed. I was right. And I became more and more involved. And one day, I found, gradually, that what I had started to do, was not something I had taken over, but it had taken over me. And I've been at it ever since.

### A Sense of Mission

So, I've had many missions along the way, but it's that simple. I wander through life with a certain, shall we say, tropism, a certain disposition, which I can trace back to childhood, early childhood, even pre-school childhood. A stubborn cuss, who would never accept what I didn't believe, and could not be beaten into believing it, or appearing to believe it. They tried to beat me into believing it, I would disbelieve it all the more violently, and all the stronger. Because if they were beating me, they were wrong.

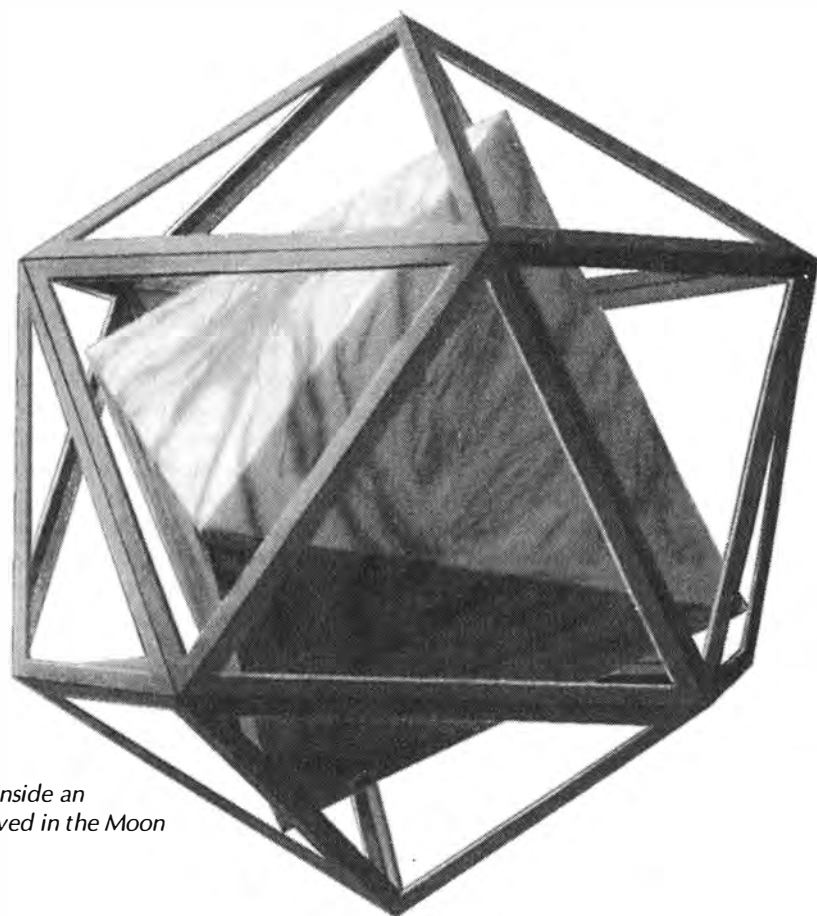
So, . . . that's the way it happened. And it was very fortunate, because by having this kind of attitude, I missed a lot of the mistakes that other people make, who try to adapt too easily to the garbage that's floating around them.

I think that's—Jason, what else can I say?—I mean, that's me, in a nutshell. That's the whole. I just keep getting grabbed up by missions, and the mission grabs me, and I'm not running the mission, the mission's running me. I'm not running for President. Working as a shadow President of the United States has taken me over; I haven't taken it over.

# The Elements, The Solar System, and The Prebiotic Principle

by Laurence Hecht

*A new look at the geometric model of the atomic nucleus proposed by Robert J. Moon, a physical chemist in the anti-Bohr tradition.*



*An octahedron nested inside an icosahedron, as conceived in the Moon model.*

Illustration by Christopher Sloan

**T**he coincidence of the Moon nuclear model—taken as a topological ordering principle for the 92 elements—with the Kepler ordering of the planetary orbits, has not been sufficiently explored (see accompanying article, page 31, for summary of the model). My recent experimental-constructive investigations, pursuing the placement of neutrons in the vacancies allowed in the Moon-model geometry, confirm the validity of the Moon model in accounting for a variety of otherwise anomalous features of nuclear chemistry. These include, especially, the leading anomalous features of the ordering of the isotope species, sometimes referred to as “magic numbers,” and related peculiarities of the nuclear

transmutations, which are explained under the Moon nuclear model in a way that should begin to supplant the patchwork quilt of Ptolemaic formulations employed in the “standard model” approach to nuclear physics.

I will elaborate these matters, still under investigation, in greater detail in a subsequent report. Meanwhile, certain more general considerations, bearing on the question raised in a number of Lyndon H. LaRouche’s recent works,<sup>1</sup> of the relationship among the distinct, but multiply connected domains of biotic, abiotic, and cognitive, have come to light in the course of this work. I confine myself here, largely to these general considerations.

Kepler's ordering of the planetary orbits, as derived in his 1596 *Mysterium Cosmographicum*<sup>2</sup> proceeds in the sequence:

- octahedron
- icosahedron
- dodecahedron
- (a discontinuity marked by the tetrahedron)
- cube.

The Moon nuclear model describing the ordering principle for the 92 elements, proceeds in the sequence:

- cube
- octahedron
- icosahedron
- dodecahedron
- (a discontinuity marked by the partial formation of a second, twinned dodecahedra/icosahedra shell)
- cube
- octahedron. . ., etc.

If, in Kepler's model, a cube is inscribed within the sphere which designates the orbit of Mercury, and, within that cube, a sphere, which designates the region of immediate influence of the Sun, it is seen more clearly that the orderings are virtually the same!

Knowing what we know of the significance of the Platonic solids as a topological ordering principle, and of the principle variously expressed as *microcosm-macrocosm*, or Leibniz's *monad*, it would be both foolish and irresponsible to acquiesce to the crude empiricism and radical indifferentism of contemporary scientific discourse, either in giving ground to the argument that these are merely matters of "coincidence," or, in failing to recognize their crucial importance, because they are "merely" of a topological, as opposed to metrical, nature. The demand of present-day ignoramuses, most often of mathematical-physics training, that one must "prove it—show me how it corrects a measurement of some existing (non-understood) fundamental value," is what is to be avoided here. Even a scant familiarity with the actual history of scientific progress, will show that all important discoveries of physical principle proceed by identification of an appropriate transfinite ordering principle governing crucial anomalies. As with Kepler's solar system, so with Mendeleev's explicit rejection of the Galileo-Newton universe, in his recognition that the atomic masses of the elements do not obey a continuous function, but are *periodic*.<sup>3</sup>

### The Prebiotic Principle

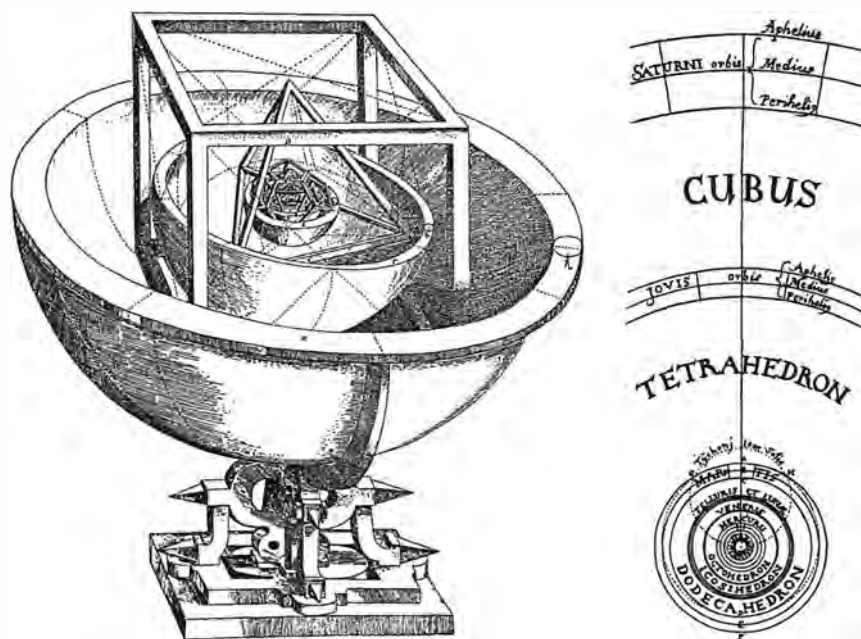
By *prebiotic principle*, I mean, in first approximation, the evidence that something resembling life is present in the developmental process governing the elements and nuclides. Familiarize yourself with the *Aufbau Prinzip* (con-

struction principle) of the nuclides, as determined by the Moon model, and you will recognize, as I did recently with a Eureka-like shout: "These are individuals!" That is—as I discovered through several weeks of concentrated, hands-on experience—in constructing the Moon model structure including the neutron placements, no attempt to extrapolate (as by a preconceived notion of directionality) the configurations of successive elements, or their isotopes is possible.

The configuration of each successive element, and even of each successive isotope, introduces some new topological relationship, reflecting the fact that the nested array of Platonic solids (and the subsumed sequence of cyclic solids defined by the edge midpoints) is governed by a multiply connected topological ordering.<sup>4</sup> The reason for the failure of earlier efforts to derive such an *Aufbau Prinzip* was the rejection of Kepler's Pythagorean-Platonic conception of ordering. Thus are all efforts to construct the nucleus out of such reductionist notions as the close-packing of spheres (Pauling, Monti, et al.), Goepfert-Mayer and Jensen's shell model, and the even more ivory-tower-like approach of the standard-model theory, doomed to failure.

As an aid to adducing a clearer conception of my use of the term *prebiotic*, note the following two points.

First, the periodic table can be seen as a kind of menagerie of the sort which Geoffroy-St. Hillaire and the young Cuvier worked with in Paris of the 1790s. The periodic table is the zoological laboratory, where creatures of the sort Leibniz called *lesser monads* are to be found and studied. The key to their classification is the Moon nuclear model. The individuality of each nuclear species (element), and its varieties (isotopes), is the strongest indictment of the crude form of atomism—decisively rejected by both Lavoisier and Mendeleev—in which each element is seen merely as the agglomeration of successive numbers of elementary parts. These are individuals. Hence, the first hint for use of the term *prebiotic*.



Kepler's ordering of the planetary orbits and the Platonic solids, reproduced from his 1596 *Mysterium Cosmographicum*.

The second point brings us to another crucial feature of what Leibniz called his Monadology, one also referenced by Nicholas of Cusa under the headings minimum-maximum principle and microcosm/macrocosm: Namely, the evolutionary principle for these species of lesser monads (and here, as with the case of biology, one must avoid being drawn into attempts to explain evolution by plausible “mechanisms”), is the topological relationship governed by the dodecahedron and golden section. The same principle expresses itself in living processes. Thus, we have the identical topological organizing principle expressing itself in events on an astronomical, visible, and *microphysical* scale. The first and last lie in the domain of abiotic process; the middle lies in the domain of living.

The identity of topological ordering principle in the astronomical and biological domains has been known since the time of Kepler. In his beautiful paper inspired by Braun and Schimper’s 1828 discovery of the law of phyllotaxis, Gauss’s American devotee Benjamin Peirce extended that identity, by demonstrating the appearance of the Fibonacci series in the relationships of the periods of successive planets—a relationship he humorously dubbed the “vegetable principle” in the universe.<sup>5</sup> Dr. Moon’s nuclear model demonstrates that same principle of golden-section-ordered topology, as governing the microcosm. No atomic nucleus is without it. Thus, the abiotic domain is suffused with a principle which finally finds its fuller expression in the biotic. Hence, again, the term “prebiotic.”

#### Schroedinger’s Confusion on Crystallization

An apparent confusion, overemphasized by Schroedinger’s treatment of the topic, arises in the study of crystallography. Schroedinger attempted to illustrate the distinction of living from nonliving, by reference to the distinction between crystal growth and the growth of a biologic organism.<sup>6</sup> The former appears as a process of agglomeration of identical parts (although that conception itself breaks down upon closer examination), exhibiting the six-fold symmetries of cube and octahedron. The latter is a developmental growth, characterized by differentiation, and exhibiting the five-fold symmetry of the icosahedron-dodecahedron and the divine proportion. In Schroedinger’s formulation, the former is entropic, the latter non-entropic. However, once the evidence demonstrated by the Moon nuclear model is taken into account, the superficiality of the Schroedinger treatment is seen.

Beneath the surface of the molecular or ionic chemistry, which is usually taken as determining the crystalline forms, lie the nuclear processes which are determining, even if our present understanding cannot elaborate exactly how. There are no ions or molecules, and therefore no electronic chemistry, without nuclei. And there, in the nucleus, the evidence of an ordering principle common to living processes appears again. It is not life, but it expresses the principle in an inchoate form; it is prebiotic.

Crystallization is a most interesting phenomenon, and a most important one in the history of scientific progress. It is Schroedinger’s misevaluation of the similarity and differences between crystallization and organic growth which is misleading. The problem arises, in part, from an artificial separation of nuclear “physics” from chemistry, a problem which reflects

a deeper epistemological sickness within the body of science. No form of chemical combination, including the crystalline state, can be properly understood apart from the understanding of the nucleus. Thus, recognizing the validity of the Moon nuclear model as a topological ordering principle for the microcosm, we would see the crystalline form as an intermediate expression of that. Crystals, then, are like the hair and nails of the prebiotic microcosm. To attempt to conclude fundamental facts from the study of crystallization, in itself, would be like studying animal physiology, while restricting one’s investigations to the fur and scales of the beast.

Yet, even such an approach, properly carried out, could yield fruit, for there is no place in the universe where the hand of creation will not show itself. Two types of anomalies associated with crystalline growth are noteworthy in this connection.

First, is the recently discovered phenomenon, observed in the case of metal alloys subjected to extreme conditions, of the appearance of quasiperiodic crystalline forms of five-fold symmetry. Second, and more curious, are certain anomalous conditions of the crystalline state, noted by Pasteur, which also suggest a higher, non-entropic organizing principle. Here, for example, we find the selective rotation of the plane of polarization of light by chiral crystals. The specific handedness of the crystals formed by the living substance is only one expression of this anomaly. The prebiotic principle is equally revealed in the paradoxical fact that the solution of such chiral crystals, itself, acts, in part like a crystal, rotating the plane of polarization of the incident light, but also, in part like an anisotropic substance, in that the same rotation occurs *irrespective* of the direction of incidence of the light.

In this most paradoxical phenomenon, one finds a hint of an ordering principle which must lie outside the ordinarily conceived laws of crystallization. A closer consideration of an even more elementary feature of crystallization suggests the same thing. For, ask yourself, why do the faces of a growing crystal remain flat? The usual explanation, that the rates of growth in particular directions are somehow favored, leaves something to be desired. One is led to the view that the solution from which the crystal grows is itself a “quantized space.”

A fuller treatment of the topic would require an examination of the seeming appearance of entropy under certain exceptional conditions. We leave this for another time. Our treatment of crystallization demonstrates the type of approach to be used. Leibniz’s works on dynamics had already shown the absurdity of the Newtonians’ introduction of the entropy concept into physics. The introduction of this concept into chemistry, by Clausius, Maxwell, et al. comes from a foolish interpretation of statistical gas laws. What can properly be adduced from such considerations are the notions of *atomicity* and *quantum of action*. The first was so adduced, as Ampère reports his independent discovery of the Avogadro Law in the 1814 “Lettre a Berthollet,”<sup>7</sup> by consideration of Mariotte’s (Boyle’s) Law and the calculus of probabilities; the second, by Planck’s considerations of the anomalies of blackbody radiation. The relevant, special importance of Ampère’s much overlooked 1814 work, is that Gay-Lussac’s Law of Simple Proportions, and chemical combination in general, is given a geometric treatment, under which the laws of crystallization are naturally subsumed.

Had Ampère's methodological approach taken hold, instead of the bookkeeping representation of chemical formulae which still persists in spite of all contrary evidence, the silly representation of entropy could not have arisen. Clausius would probably have drowned himself in a large fishbowl, like Thomas Gray's favorite puss, grasping for the gold prize. I suspect the actual law of entropy is this: Let a fool suspect that he has got his hands on the "ultimate particle," and he will surely wear it down with rubbing.

### On Elements and the Solar System

The correspondence of topological ordering principle in the Moon and Kepler representations, bears also on the general topical areas: the origin of the solar system, and the synthesis of the elements.

Before entering into this admittedly still very conjectural topic, I think a word of warning is necessary. Most efforts to account for the origin of the solar system, as with cosmology in general, are marred by the introduction of *ad hoc* assumptions which extend far beyond what scientific evidence would permit. Once these assumptions are granted, the formulations of an ivory-tower mathematical-physics are applied, to produce a plausible "model" resembling the desired result. The same flaw is introduced in most approaches to the problem of the synthe-

sis of the heavier elements; there is too much air, and not enough ground. It is an important part of one's self-inoculation against such hoaxes, always to keep in mind that theories of origin, and cosmology in general, have ever been closely associated with the needs of an oligarchical ruling elite.

That said, several things are suggested by the correspondence of the Moon and Kepler models. Here follow some scant, early reflections on the subject. At first sight, the solar system, in its gross structure, appears to be an incomplete expression of the same ordering principle governing the elements. Where there are 92 principal singularities on the latter and 148 more of derived nature, the solar system shows only a mere nine principal orbits, and some moons, these all restricted largely to a single plane. Yet, in some way the opposite must be the case—the solar system, which is the more developed form, must be the more developed expression of the ordering principle. The fact that all matter within this solar system is composed of huge numbers of tiny nuclei, each built upon the same plan as the structure in the large, is one expression of this, and also a beautiful embodiment of the macrocosm/microcosm principle.

Certain features of the two systems, however, are the same. The appearance of the discontinuity following the dodecahedron corresponds in the one case, to the distinc-

**Periodic Table of the Elements**

	Periodic Table of the Elements																Inert Gases									
																	O									
	1A											2						10								
1	1 H 1.00797											2 He 4.00260						10								
	IIA												3	4	5	6	7	8	9	10						
2	3 Li 6.941	4 Be 9.01218											5 B 10.81	6 C 12.011	7 N 14.0067	8 O 15.9994	9 F 18.99840	10 Ne 20.179								
	11	12											13	14	15	16	17	18								
3	Na 22.98977	Mg 24.305											Al 26.98154	Si 28.086	P 30.97376	S 32.06	Cl 35.453	Ar 39.948								
			IIIB	IVB	VB	VIB	VIIB	VIII			IB	IIB														
4	19 K 39.098	20 Ca 40.08	21 Sc 44.9559	22 Ti 47.90	23 V 50.9414	24 Cr 51.996	25 Mn 54.9380	26 Fe 55.847	27 Co 58.9332	28 Ni 58.70	29 Cu 63.546	30 Zn 65.38	31 Ga 69.72	32 Ge 72.59	33 As 74.9216	34 Se 78.96	35 Br 79.904	36 Kr 81.100								
	37	38	39	40	41	42	43	44	45	46	47	48	49	50	51	52	53	54								
5	Rb 85.4678	Sr 87.62	Y 88.9059	Zr 91.22	Nb 92.9064	Mo 95.94	Tc 98	Ru 101.07	Rh 102.9055	Pd 106.4	Ag 107.868	Cd 112.40	In 114.82	Sn 118.69	Sb 121.75	Te 127.60	I 126.9045	Xe 131.30								
	55	56	57	72	73	74	75	76	77	78	79	80	81	82	83	84	85	86								
6	Cs 132.9054	Ba 137.34	*La 138.9055	Hf 178.49	Ta 180.9479	W 183.85	Re 186.207	Os 190.2	Ir 192.22	Pt 195.09	Au 196.9665	Hg 200.59	Tl 204.37	Pb 207.19	Bi 208.9804	Po (210)	At (210)	Rn (222)								
	87	88	89	104	105	106																				
7	Fr (223)	Ra 226.0254	†Ac (227)	Ku	Ha																					
													58	59	60	61	62	63	64	65	66	67	68	69	70	71
													Ce 140.12	Pr 140.9077	Nd 144.24	Pm (147)	Sm 150.4	Eu 151.96	Gd 157.25	Tb 158.9254	Dy 162.50	Ho 164.9304	Er 167.26	Tm 168.9342	Yb 173.04	Lu 174.97
													90	91	92	93	94	95	96	97	98	99	100	101	102	103
													Th 232.0381	Pa 231.0359	U 238.029	Np 237.0482	Pu (244)	Am (243)	Cm (247)	Bk (247)	Cf (251)	Es (254)	Fm (257)	Md (258)	No (255)	Lr (256)

1 H 1.0079	atomic number
atomic mass	

tion of the small, earthy inner planets from the large gas giants beyond the asteroid belt; in the other case, to a rough distinction between light and heavy, abundant and rare, elements. The four shells, cube-octahedron-icosahedron-dodecahedron, represent the domains of Mercury, Venus, Earth, Mars, with the hydrogen-rich Sun at center, and this must in some way correspond to the nucleosynthesis. Thus, imagine the surrounding space as a great solution within which the solar system crystallizes, not by the laws of solution chemistry, but by the underlying principle expressed in nucleus and solar system.

As I contemplate these things, I see reflected in the pentagonal Plexiglas face of my model of the Moon nucleus, the wind-blown leaves of a large maple tree (pentagonal leaves, if you have ever examined them), and through them a very blue, spring sky. There, in the momentary contemplation of a single image, the multiply connected domains of prebiotic, living, and creative express themselves in unitary simplicity, and conspire to produce a feeling of spiritual pleasure.

*The author is the editor-in-chief of 21st Century. This article was written April 27, 2003.*

#### Notes

1. See, for example, Lyndon H. LaRouche, Jr., "The Weird Religions of Cheney's Empire: The Pantheo-cons," *Executive Intelligence Review*, May 2, 2003, pp. 12-35.
2. Johannes Kepler, *Mysterium Cosmographicum*, (New York: Abaris, 1981), As Kepler remarks in notes added 25 years after the first publication, the germ of all his subsequent work, leading to the discovery of the principle of universal gravitation and the *Harmonies of the World*, is contained in this early (1596) work of his.
3. D. Mendeleeff, "The Periodic Law of the Chemical Elements," (Faraday Lecture, June 4, 1889), in D. Mendeleeff, *The Principles of Chemistry*, Third English Edition (London: Longmans, Green, 1905; New York: Kraus Reprint, 1969) Vol. II, Appendix II.
4. I discovered this in an investigation of the reason behind the magic numbers 50 and 82. Each represents a different anomalous feature of the Moon model construction. For example, the reason for the extraordinary stability of 50-Sn (tin) is the completion of the first pentagonal ring (the "scalloped salad bowl") of the twinned dodecahedron. One would have expected this structure to appear at atomic number 51, when five protons have been added to the 46 of the first completed structure. The completely unexpected nature of this particular *individual* (50-Sn) derives from the fact that the proton from the underlying icosahedron on the face of the first complete (46-proton) structure "pops up" to form the fifth proton in the ring on the twinned structure. This explains both the reason why tin expresses itself in the greatest number of stable isotopes (10) of any element, and also the extraordinarily anomalous, "forbidden" transmutation of 49-indium-115 into 50-tin-115.  
Similarly, in respect to the "magic number" 82. In the careful construction of the elements of the Lanthanide series (itself an anomaly, the gross features of which are readily explained by the Moon model), it is seen that the structural anomaly producing the "magic" number of 82 neutrons arises from the need to locate the octahedron within the partially completed dodecahedral and icosahedral "salad bowls." Because of the skew positioning of the octahedral vertices within the face of the icosahedron, the protons forming at the octahedral vertices lie on a sphere which is almost equivalent in radius to the midsphere of the icosahedron, upon which the neutrons lie. Thus, in the formation of some of the first members of the Lanthanide series, the addition of protons, which, in the general case, will create more neutron positions, actually eliminates some neutron positions. This is the reason that successive even-numbered elements in the series continue to show 82 neutrons in their stable isotopes.
5. B. Peirce, "Mathematical Investigations of the Fractions which Occur in Phyllotaxis," *Proceedings of the American Academy for the Advancement of Science* (1849), pp. 444-447.
6. Erwin Schroedinger, *What Is Life?* (Cambridge University Press, 1944).
7. André-Marie Ampère, "Lettre de M. Ampère a M. Iecomte Berthollet sur la détermination des proportions dans lesquelles les corps se combinent d'après le nombre et la disposition des molécules dont leurs particules intégrantes sont composées," *Annales de Chimie*, Tome 90 (30 April 1814), pp. 43-86 + 2 planches.

# What Is The Moon Model Of the Nucleus?

In 1986, Dr. Robert J. Moon, the University of Chicago physical chemist and veteran of the Manhattan Project, conceived a new model for the atomic nucleus, which could account for many of the otherwise anomalous properties of the elements and isotopes.<sup>1</sup> Moon's was the first comprehensive attempt, since Dmitri Mendeleev proposed the Periodic Table in 1869, to find a new principle governing the ordering of the elements.

Dr. Moon had been a key participant in a mid-1980s seminar series, which was conducted by Lyndon H. LaRouche, Jr. with some of the leading non-Establishment figures in plasma physics, biophysics, and related disciplines. The seminar series was a crucial part of LaRouche's efforts at the time to push forward his proposal for the Strategic Defense Initiative, partially adopted by President Ronald Reagan in 1983, as a science-driver project.<sup>2</sup> The method of Johannes Kepler, in his discovery of the principle of Universal Gravitation and founding of modern experimental science—as distinct from the crude empiricism of Galileo and Newton—was a frequently visited topic in these discussions.

Sometime in the spring of 1986, at the prompting of Charles B. Stevens, a leading collaborator of LaRouche on science matters, Dr. Moon undertook a concentrated study of LaRouche's epistemological writings, supplemented with a reading of Kepler's *Mysterium Cosmographicum*. A lifetime of immersion in physical chemistry and nuclear physics, which had begun with his youthful apprenticeship to William Draper Harkins at the University of Chicago, came to fruition that spring in the still quite fertile and imaginative mind of the then 74-year-old Moon.

I first saw the Moon model of the nucleus early in the summer of 1985. Moon had inspired a retired machinist friend, George Hamann, to build a set of nested Platonic solids in the ordering and sizes specified. Using that model, made from used aluminum printing plates, Dr. Moon first showed me the construction of the atomic nuclei for the 92 elements. In Moon's model, the ordering principle for the protons is represented by the vertices of a nested structure of four of the five Platonic solids (Figure 1). Eight protons, corresponding to the Oxygen nucleus, occupy the vertices of a cube which is the first nuclear "shell." Six more protons, corresponding to Silicon, lie on the vertices of an octahedron, which contains, and is dual to, the cube. The octahedron-cube is contained within an icosahedron, whose 12 additional vertices, now totalling 26 protons, correspond to Iron. The icosahedron-octahedron-cube nesting is finally contained within, and dual to, a dodecahedron. The 20 additional vertices, now totalling 46 protons, correspond to Palladium, the halfway point in the



periodic table (Figure 2).

Beyond Palladium, a second dodecahedral shell begins to form as a twin to the first. After 15 of its 20 vertices are filled at Lanthanum (atomic number 56), a cube and octahedron nesting fill inside it, accounting for the 14 elements of the anomalous Lanthanide series.

Next, the icosahedron forms around the cube-octahedron structure, completing its 12 vertices at Lead (atomic number 82), which is the stable, end-point in the radioactive decay series. Finally, the dodecahedron closes, and the twinned structure "hinges" open, creating the instability which leads to the fissioning of uranium (Figure 3).

The completed "shells" of the Moon model, correspond to the elements whose stability is attested by their abundancy in the Earth's crust: Oxygen, Silicon, and Iron. These elements also occur at *minima* in the graphs of atomic volume, and of other physical properties (viz. compressibility, coefficient of expansion, and reciprocal melting point) as established by Lothar Meyer in the 1870s to 1880s. Palladium, which is an anomaly in the modern electron-configuration conception of the periodic table—because it has a closed electron shell, but occurs in the middle of a period—is not anomalous in the Moon model. Further, all four closed-shell elements in the Moon model occur at maxima on the graph of paramagnetism (versus atomic number), as reported by Harkins.<sup>3</sup>

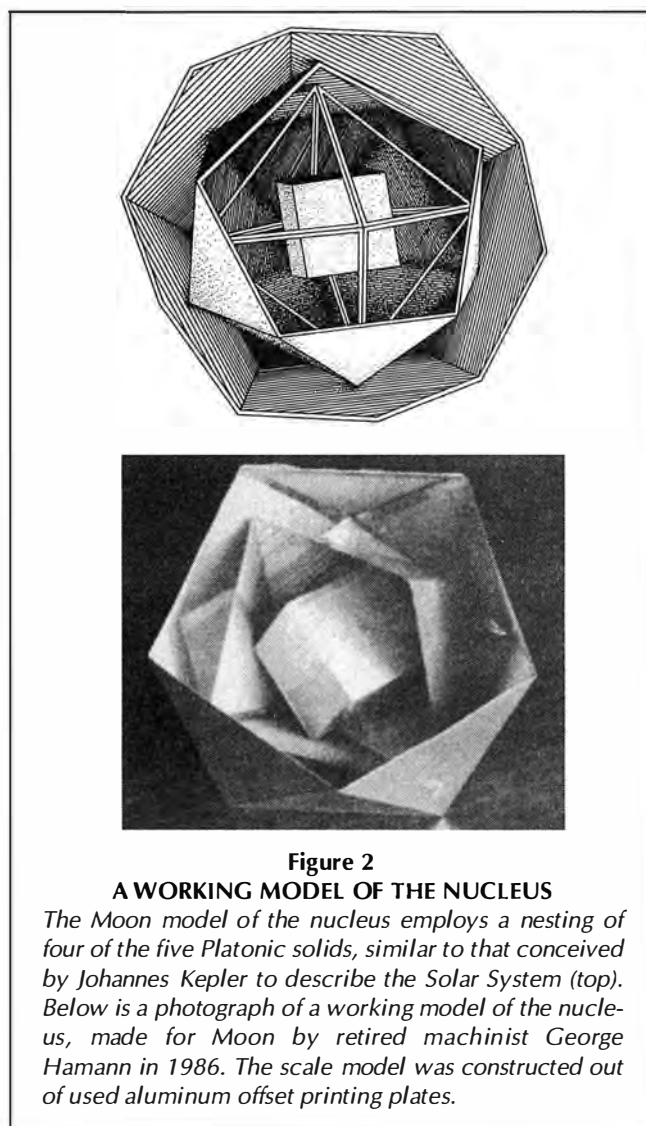
The Moon model is thus consistent with much of the same experimental data which underlie the periodic table of the elements, and explains additional features not explained by

the modern, electron-configuration presentation of the periodic table. However, it seems to be inconsistent with the evidence from spectroscopy (upon which the electron-configuration conception rests) which suggests the periods of 2, 8, 18, and 32; it also appears, at first, inconsistent with the older "law of octaves," which was developed to explain the phenomena of chemical bonding, and was subsumed in Mendeleev's conception.

### An Ordering of Neutrons

From the period of my first exposure to Moon's nuclear model, I was of the opinion that the two apparently contradictory orderings (electron and proton) must be governed by some higher principle, which was in some way contained in the Moon conception. Moon encouraged such speculations, pointing out that the theory of electron orbits (the "extra-nuclear electrons," as he insisted on calling them), had always suffered from an aseptic separation of the electron from the nucleus.

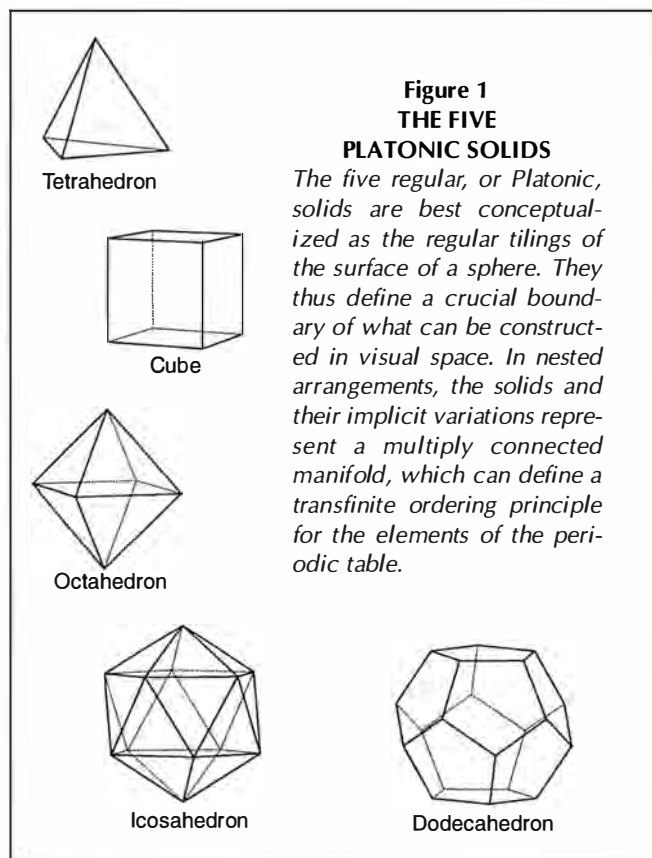
During his lifetime, I worked out an ordering principle,



**Figure 2**

### A WORKING MODEL OF THE NUCLEUS

The Moon model of the nucleus employs a nesting of four of the five Platonic solids, similar to that conceived by Johannes Kepler to describe the Solar System (top). Below is a photograph of a working model of the nucleus, made for Moon by retired machinist George Hamann in 1986. The scale model was constructed out of used aluminum offset printing plates.



**Figure 1**  
**THE FIVE**  
**PLATONIC SOLIDS**

The five regular, or Platonic, solids are best conceptualized as the regular tilings of the surface of a sphere. They thus define a crucial boundary of what can be constructed in visual space. In nested arrangements, the solids and their implicit variations represent a multiply connected manifold, which can define a transfinite ordering principle for the elements of the periodic table.



Philip Ulanowsky

Dr. Moon around the time that he conceived of his model of the nucleus.

using the edge midpoints and unfilled faces of his nested configuration, to determine the otherwise undetermined distribution of the neutrons in the nuclei.<sup>4</sup> In any Platonic solid, there are three implied spheres of differing radii. The unique characteristic of the Platonic solids is the existence of a circumscribing and inscribing sphere. Intermediate between these, there is a sphere, sometimes referred to as *midsphere* (Figure 4). For the two pairs of dual Platonic solids (cube-octahedron and icosahedron-dodecahedron), the midspheres pass through the vertices of the two related Archimedean solids, that is, the cuboctahedron and icosidodecahedron. (These cyclic, Archimedean solids, are formed by connecting the midpoints of either of the Platonic solid duals.)

The existence of this subsumed ordering principle of the cyclic Archimedean solids, within the multiply connected ordering of the nested Platonic solids, suggested the appearance of a new physical singularity in this region. So, this third

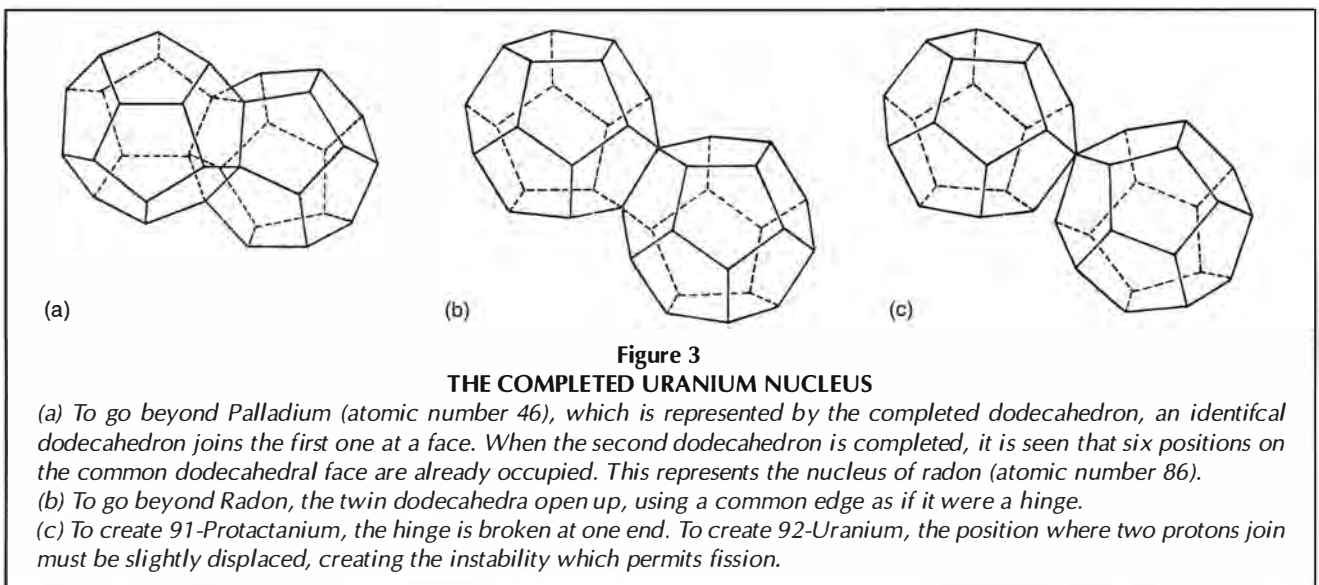
set of spheres was to be the primary location for the neutrons, in my extended conception of Moon's model. I assumed the addition of the fifth Platonic solid (tetrahedron) as the structure of an alpha particle at the center of the nucleus, and distributed the neutrons at the unoccupied edge-midpoints of the set of solids. When I did so, I found that the neutron "shells" closed at the electron-shell singularities (2-Helium-4, 10-Neon-20, 18-Argon-40, 36-Krypton-84), specified in the modern periodic table (See table, p. 34).

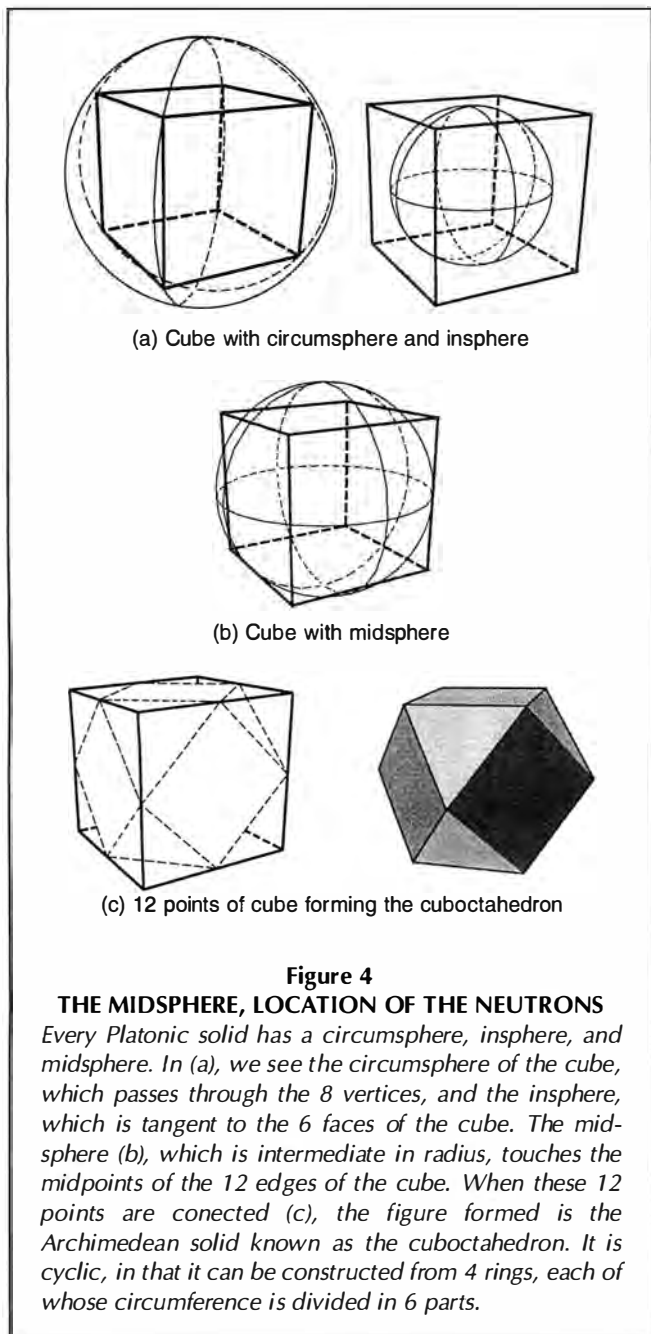
This suggested, for the first time, a relationship between the ordering of the nucleus and that of the electron shells. However, I could not see a cause for a relationship between the supposedly neutral neutrons, and the extranuclear electrons. The difficulty suggests some error of assumption, which must be contained in the oversimplification provided by the Rutherford-Bohr model.

Three years ago, aided by my recent study of the Ampère-Gauss-Weber electrodynamics, I made an attempt to establish a physical cause for the Moon model structure, by imagining the protons as occupying a set of current rings, like the Ampère *magnetic molecule*, which rings were arranged to correspond to the symmetries of the nested solids.<sup>5</sup> This did not prove entirely satisfactory.

More recently, at LaRouche's suggestion, I dropped the effort to explain the Moon model in terms acceptable to existing physics practice, the thinking being that there is something new here, which, by its nature, could not be explicable in the old terms. Rather, I concentrated on looking at some of the key anomalies in the existing view of the ordering of elements and isotopes, and examined how the Moon model, considered as a valid ordering principle for the nuclear structure, could resolve them. With that in mind, a suggestion by Dr. Ben Soldano proved useful. In noting to him, the seemingly paradoxical coincidence in ordering between the neutrons and the extranuclear electrons, referred to earlier, he suggested looking at the nuclear transmutations, such as the *K-capture*, and electron and positron emissions.

That soon led me back to an examination of the so-called



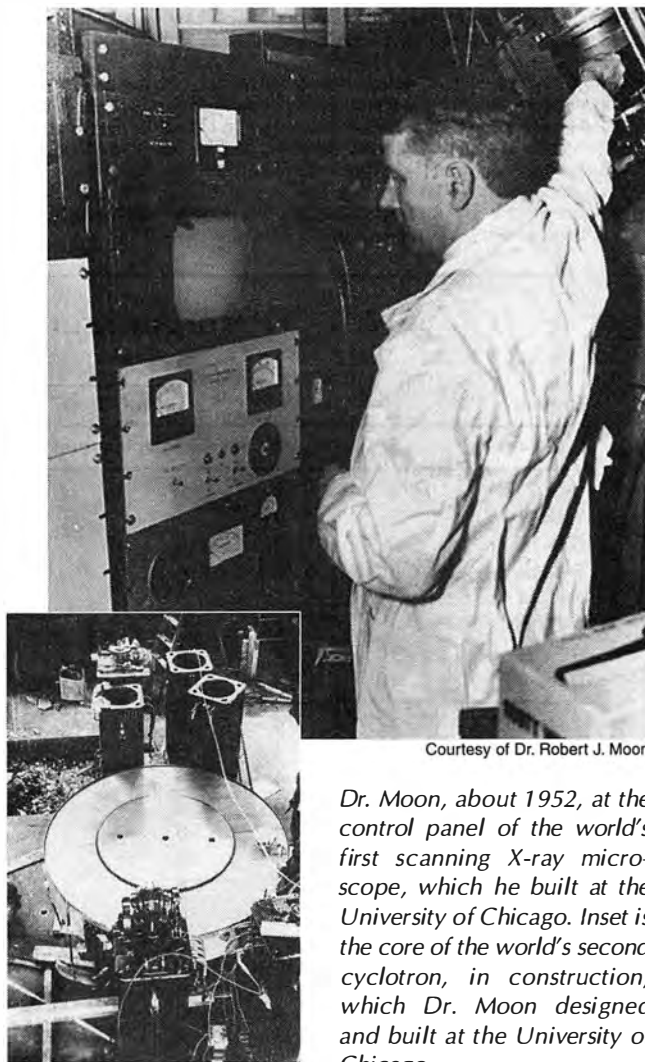


**Figure 4**

**THE MIDSHERE, LOCATION OF THE NEUTRONS**

Every Platonic solid has a circumsphere, insphere, and midsphere. In (a), we see the circumsphere of the cube, which passes through the 8 vertices, and the insphere, which is tangent to the 6 faces of the cube. The midsphere (b), which is intermediate in radius, touches the midpoints of the 12 edges of the cube. When these 12 points are connected (c), the figure formed is the Archimedean solid known as the cuboctahedron. It is cyclic, in that it can be constructed from 4 rings, each of whose circumference is divided in 6 parts.

*magic numbers*. Rather than accepting the usual interpretation of spin-orbit coupling and other tenuous concepts to explain these phenomena, I simply viewed the magic numbers as a catalogue of anomalies, of unusually stable isotopes and “forbidden” transmutations. I looked, in particular, at the magic numbers 50 and 82, wishing to see how the complex geometry of Moon’s nested nuclear model might favor that number of protons or neutrons. This required a more exact construction of the Moon model representation for some of these heavier nuclei, than I had previously carried out. The results were rewarding. A summary description is provided in Note 4 to the main article here (p. 30). These could be taken as preliminary confirmation of the extended validity of the Moon’s nuclear



Courtesy of Dr. Robert J. Moon

*Dr. Moon, about 1952, at the control panel of the world’s first scanning X-ray microscope, which he built at the University of Chicago. Inset is the core of the world’s second cyclotron, in construction, which Dr. Moon designed and built at the University of Chicago.*

hypothesis, respecting the otherwise unexplained reason for the distribution of the isotopes, the second “tier” of the periodic table.

—Laurence Hecht

**Notes**

1. Robert James Moon (1911-1989) began studies at the University of Chicago at the age of 16, in 1928. Wishing to solve the problem of controlled thermonuclear fusion, he went to Arthur Compton, then chair of the Physics Department, who sent him to the chairman of the Department of Physical Chemistry, William Draper Harkins. Harkins had challenged the Bohr orbital model of the atom as early as 1917, arguing (1) that no known chemical system was flat, like the proposed Bohr orbits which form the basis for modern quantum mechanics; and (2) Bohr’s system limited itself to radiation phenomena, although the chemical knowledge of the atom was much broader. Moon earned a doctoral degree in Physical Chemistry, under Harkins, and then one in Physics, and taught in both departments at the University of Chicago. In the mid-1930s, Moon led construction of the second cyclotron in the world, with many improvements over the first device constructed by E.O. Lawrence (Moon, R.J. and Harkins, W.D. *Science*, Vol. 83, No. 244 (1936). During the Manhattan Project, he solved the problem of the carbon moderator, making the first atomic pile possible. After the war, he constructed the first scanning X-ray microscope, and pioneered in optical biophysics studies on the action potential in nerves. Moon’s study of the electrodynamic theories of André-Marie Ampère and Wilhelm Weber, led him to reconsider the usual interpretation of the Rutherford scattering data, which ignores the variation in force between charged particles as a result of relative velocities and accelerations.

Calculations based on the Weber Electrodynamics Law, forced Moon to re-conceptualize most of what is, still today, taken for granted in atomic and nuclear physics.

From 1974 onward, he was a key collaborator of Lyndon H. LaRouche, Jr. A founding member of the Fusion Energy Foundation, from 1984-1986 he edited its *International Journal of Fusion Energy*. He was a member of the advisory board of *21st Century Science & Technology*, until his death in 1989.

See: "Interview with Dr. Robert J. Moon" (in two parts), *Executive Intelligence Review*, Oct. 30, 1987, p. 31 and Nov. 6, 1987, p. 18; and Laurence Hecht, "The Geometric Basis for the Periodicity of the Elements," *21st Century*, May-June 1988, p. 18.

2. Dr. Ben Soldano, whose challenge to the assumption of *equivalence* (of inertial and gravitational mass) has still got the Establishment experts on General Relativity running for cover when he approaches, later compared the seminar series to the Solvay Conferences of the 1920s, in their potential importance for shaping the future of science.

3. W.D. Harkins and R.E. Hall, "The Periodic System and the Properties of the Elements," *J. Amer. Chem. Soc.*, Vol. 38, No. 2 (Feb. 1916), p. 169.

4. Hecht, *op. cit.*, pp. 25 ff.

5. Laurence Hecht, "Advances in Developing the Moon Nuclear Model," *21st Century*, Fall 2000, p. 5.

### PROPOSED NEUTRON DISTRIBUTION CHART

Element	N=	Alpha particle	Edges of				
			Tetrahedron	Cube	Octahedron	Icosahedron	
2-He-4	2	2	Complete period				
3-Li-7	4	2	2				
4-Be-9	5	2	3				
5-B-10	5	2	3				
6-C-12	6	2	4				
7-N-14	7	2	5				
8-O-16	8	2	6	Complete proton shell			
9-F-19	10	4	6				
10-Ne-20	10	4	6	Complete period			
11-Na-23	12	4	6	2			
12-Mg-24	12	4	6	2			
13-Al-27	14	4	6	4			
14-Si-28	14	4	6	4	Complete proton shell		
15-P-31	16	4	6	6			
16-S-32	16	4	6	6			
17-Cl-35	18	4	6	8			
18-Ar-40	22	4	6	12	Complete period		
19-K-39	20	4	6	10	0		
20-Ca-40	20	4	6	10	0		
21-Sc-45	24	4	6	12	2		
22-Ti-48	26	4	6	12	4		
23-V-51	28	4	6	12	6		
24-Cr-52	28	4	6	12	6		
25-Mn-55	30	4	6	12	8		
26-Fe-56	30	—	6	12	12	Complete proton shell	
27-Co-59	32	—	6	12	12	2	
28-Ni-59	31	—	6	12	12	1	
29-Cu-64	35	—	6	12	12	5	
30-Zn-65	35	—	6	12	12	5	
31-Ga-70	40	—	6	12	12	10	
32-Ge-73	41	—	6	12	12	11	
33-As-75	42	—	6	12	12	12	
34-Se-79	45	—	6	12	12	15	
35-Br-80	45	—	6	12	12	15	
36-Kr-84	48	—	6	12	—	30	Complete period
37-Rb-85	48	—	6	12	12	18	
38-Sr-88	50	—	6	12	12	20	
39-Y-89	50	—	6	12	12	20	
40-Zr-92	52	—	6	12	12	22	
41-Nb-93	52	—	6	12	12	22	
42-Mo-96	54	—	6	12	12	24	
43-Tc-98	55	—	6	12	12	25	
44-Ru-101	57	—	6	12	12	27	
45-Rh-103	58	—	6	12	12	28	
46-Pd-106	60	—	6	12	12	30	Complete proton shell

How Johannes Kepler's examination of "nothing," produces something to think about.

# Six-cornered Snowflakes and Five-fold Symmetry

by Ralf Schauerhammer

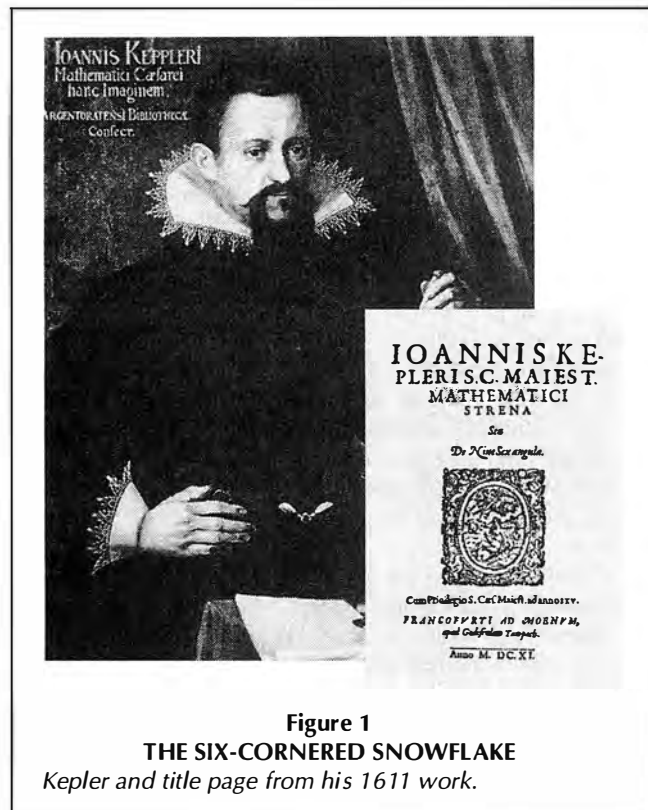


Figure 1

## THE SIX-CORNERED SNOWFLAKE

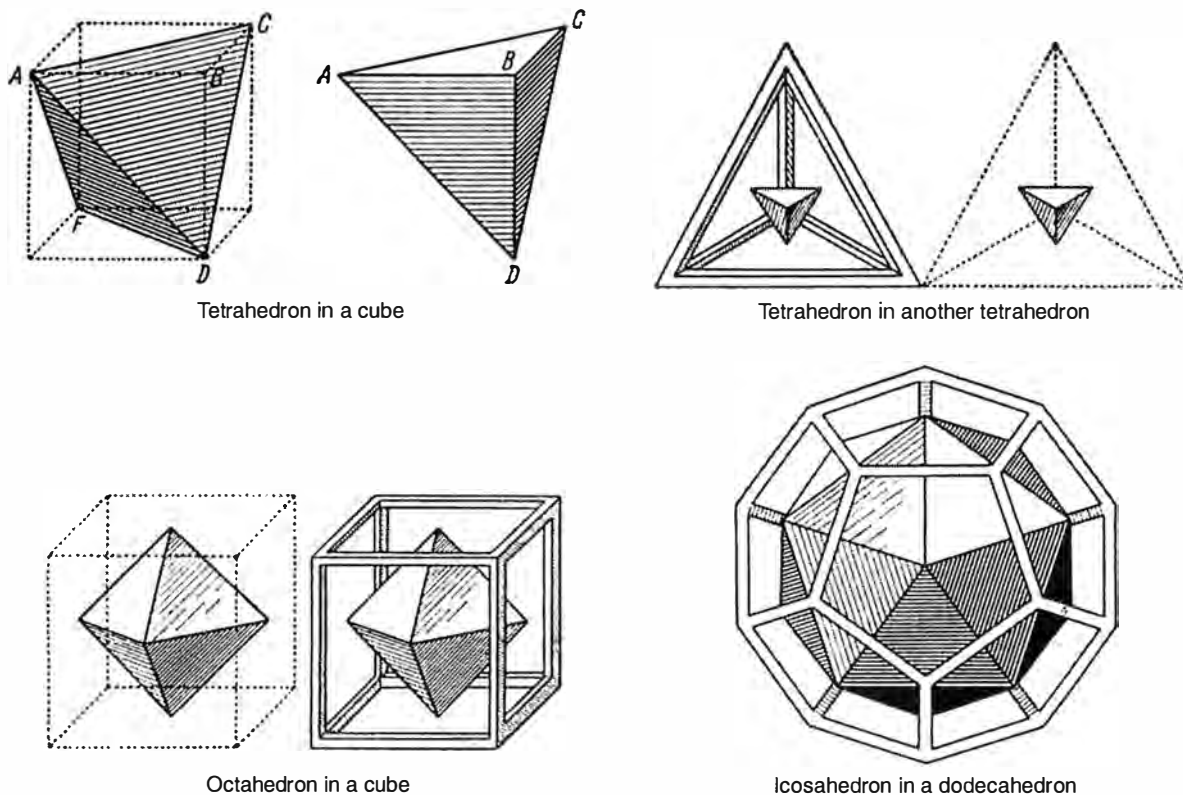
Kepler and title page from his 1611 work.

Johannes Kepler was not only a creative scientist, but an interesting and humorous man. This is especially evident in a little paper he wrote for his patron, Wacker von Wackenfels, in 1611, titled *A New Year's Gift or On the Six-Cornered Snowflake*. There, in the introduction, Kepler writes:

Yes, I know well how fond you are of Nothing; surely not so much because of its minor value, but because of the funny and delightful play, which one can have with it, as with a merry sparrow. Therefore, I imagine that for you a gift should be the better and more welcome, the more it approaches to Nothing.

With these words, Kepler starts a play of thoughts, which is still of interest today. Everybody who knows it, will take it from time to time in his hands, like a good poem, and re-read it. And just as I had taken this little work, to re-read it, and think about a way to tempt the readers of this magazine into exploring Kepler's work, another creative, interesting, and humorous man was to celebrate his 80th birthday—Lyndon H. LaRouche, Jr.

For a long time I had been thinking about what to present to a modest and joyful man like Lyndon LaRouche on his 80th birthday. Finally, my good friend, Kepler, gave me some advice: "You know, he especially likes Nothing!" And so, it was obvious what I should do for a present: Take a stout-hearted jump onto Kepler's shoulders, and continue writing on the topic of "Nothing."



Tetrahedron in a cube

Tetrahedron in another tetrahedron

Octahedron in a cube

Icosahedron in a dodecahedron

Figure 2

**THE FIVE PLATONIC SOLIDS AND THE 'COUPLES'**

Only five Platonic solids can be built from the regular (equal-sided) planar figures—the square, triangle, pentagon. These solid figures form two “couples” or duals (the cube with the octahedron and the dodecahedron with the icosahedron), and one single (the tetrahedron), which Kepler called “hermaphrodite.”

Johannes Kepler understood very well in his little work *On the Six-Cornered Snowflake* how to present “Nothing.” He starts out with a beautiful pun about *Nichts* (which is the German word for nothing) and *Nix*, which is the Latin word for snow. (In dialect and lax, everyday German, the word *nichts* is pronounced like *nix*.) Kepler writes: “If you ask a German about *NIX*, he will answer *NIHIL*, if he knows only a little of Latin.”

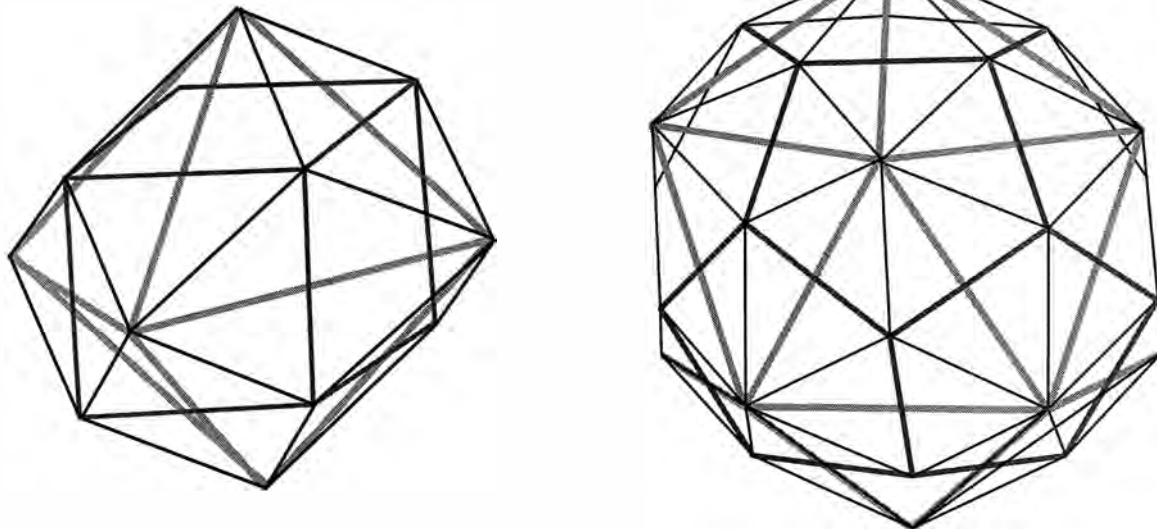
Recently I learned that Kepler’s pun is actually threefold, because “Nix” also refers to a ghost living in the water. I was not sure if this was a joke, so I checked into the matter. And indeed, in Kepler’s time the word *Nix* referred to a male ghost living in the water, who (according to the tales of sailors), looked like a hippopotamus or a seal; the romanticists later transformed this being into the female *nixie*, the mermaid. Be that as it may, it is definitely true that Kepler, in his *On the Six-Cornered Snowflake*, investigates which “ghost” sports about in the water and transforms it once in a while into *Nix*.

Historians have written a lot of clever things on Kepler’s *On the Six-Cornered Snowflake*, and call it the work that founded the science of crystallography, for example.) So it seems that “nothing” can be said about it any more. And it is exactly this “nothing” that I will now take on.

**I. The ‘Nothing’**

The nothing begins with the fact that Kepler’s relationship to Plato’s *Timaeus* dialogue is unappreciated. This is strange, because Kepler refers explicitly to the Platonic solids, which Plato uses in his *Timaeus* to construct the elements. Plato rejects the simple notion of the atom of Democritus, and Kepler agrees with Plato, when he writes in the beginning of his *Snowflake* paper, that the Epicurean concept of atoms is “really nothing.” This is no accident, because Kepler’s *Six-Cornered Snowflake*, like Plato’s *Timaeus*, deals with the question: What kind of transformations create the elements, or “atoms”? What “action” produces, from the water vapor continuum, the discontinuous snowflake in its specific geometrical shape?

It is totally wrong to say that Plato, in his *Timaeus*, takes up the so-called number magic of the Pythagoreans to explain the four elements, with the aid of five Platonic solids. The Platonic solids are rightly named after Plato, because the existence of these solids, and the fact that there can only be five of them, was first discovered by Plato’s friend Theaetetus. The Pythagoreans knew only the tetrahedron, the cube, and the dodecahedron; that is, only three regular solids. Therefore, it is not plausible, that they created an elementary theory of four



**Figure 3**  
**KEPLER'S RHOMBOIDS**

*The two rhomboids Kepler discovered (the "small" rhomboid made out of 12 faces, includes the cube and octahedron; the "big" rhomboid made out of 30 faces includes the dodecahedron and the icosahedron). These are both metaphors of the creative idea of Theatetus.*

elements on the basis of the three figures known to them. It was about 150 years after the Pythagoreans that Plato's friend Theatetus, was the first to construct the octahedron and the icosahedron.

Now another nothing: Kepler's discovery of the two regular rhomboids—the "small" 12-faced rhomboid (the rhombic dodecahedron, which was known to the Greeks) and the "large" 30-faced rhomboid (the rhombic trikontahedron)—represent exactly the new idea, which Theatetus brought to light: Each of these rhomboids is the envelope of two Platonic solids, the octahedron and the icosahedron, which Kepler calls "married couples." (Today they are known as "duals.") The octahedron is the wife of the male cube, and the icosahedron is the wife of the dodecahedron. The sharp corners of the women touch exactly the centers of the faces of the men, and vice versa; the sharp corners of the men touch exactly the centers of the faces of the women.

If one looks at a couple, not from the outside, but from the inside center, one sees a harmonic ordering of the angles from the center to the edges of Kepler's rhomboids, unifying the couple. Now, one also sees why Theatetus had to discover both Platonic solids together.

The reason that it is justified to call the regular solids "Platonic solids," can be found in the *Timaeus* dialogue. Here, for the first time, their deep physical meaning is expressed. Plato's objection to Democritus' atoms (which Democritus defined as the smallest, indivisible building-blocks out of which all matter is composed) is easy to understand, if one looks into the history of modern science.

Two-hundred years ago, the word "atom" was used to designate the tiny building-blocks of matter, which could not be bro-

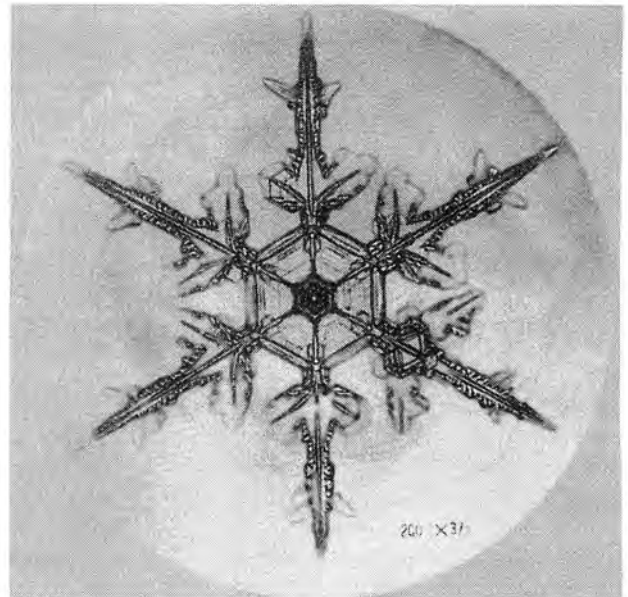
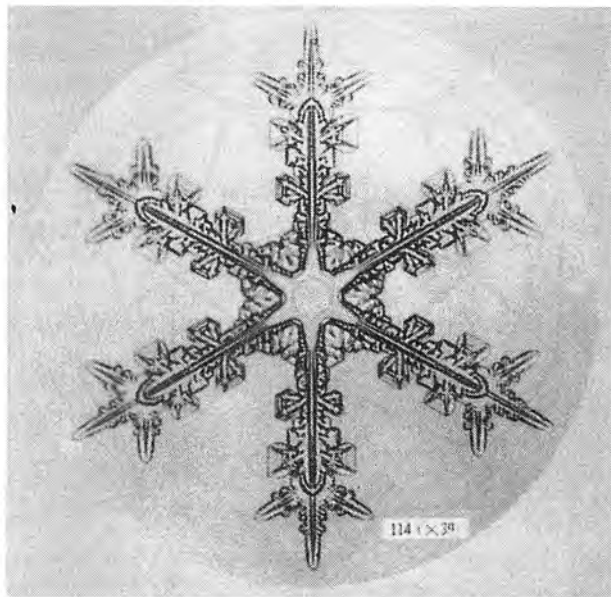
ken down further by chemical reactions. But later, about 100 years ago, in the course of the discovery of radioactive radiation and the associated nuclear reactions, those smallest building-blocks suddenly were no longer "atoms." They could be divided into something, called "elementary particles," which were smaller than atoms. Later, even these elementary particles were decomposed, using the tremendous amounts of power applied through accelerators. So there was need of a name for yet another kind of "atom," called fundamental particles.

So we see, that the word "atom" can be meaningful only if it is related to a specific transformation, an action applied in a chemical test-tube, nuclear reactor, or accelerator.

For Plato this "atom-paradox" was already clear 2,400 years ago. That is the reason he rejected Democritus' concept, and in the *Timaeus* dialogue, he described the processes that transform the elements—earth, water, air, and fire into each other. Today we call Plato's "elements"—that is, these "atoms" in relation to physical transformation—the "physical conditions" or states of matter: solid, fluid, gas, and plasma.

The relationship of the cube, icosahedron, octahedron, and tetrahedron describe the lawful geometrical constraints of those transformations. Therefore, Plato explains how those solids can be transformed into each other by a triangular construction of its regular faces. The new idea that Plato expresses in the *Timaeus*, with the help of the Platonic solids—that is, the way to make an universal physical principle of transformation geometrically knowable—today is called "natural law." And the next person who made a decisive step in developing this idea further was Johannes Kepler.

Now comes the icing on the *nix*, which belongs to this nothing. Here we have four elements, but five Platonic solids! What



**Figure 4**  
**SNOWFLAKES CAPTURED BY CAMERA**

*How much Kepler would have enjoyed seeing these photographs of snowflakes, which modern technology makes possible today.*

about the fifth solid, the dodecahedron? For this, Aristotle "invented" a special type of matter, the insensible ether, floating around in the spheres of heaven that are unreachable by man. This wrong conception is still also imputed today to Plato. But Plato states explicitly in his *Timaeus*, that ether is only a fine kind of air; that is, not a special type of element. So what is the role of the dodecahedron?

Let's look into the *Timaeus*. There one reads, "Since there remained a fifth figure, God used it for the cosmos as its ground-plan." Aha! Not the ether, but the "ground-plan" of the cosmos is related to the dodecahedron. The philologists indicate, that the Greek word that Plato uses for "ground-plan" in this context is hard to translate. In Plato's *Republic*, they say, Plato uses the same word for the "basic outlines" that the "blissful state" must have according to the "divine model." So, the dodecahedron contains this universal quality, and its transformation serves the cosmos as "ground-plan."

The dodecahedron is thus something exceptional. And whoever has tried to construct the Platonic solids from scratch, knows this: Once you get the dodecahedron, the rest is child's play. Plato, however, did not think simply in terms of geometrical construction, but in terms of different qualities of universal processes: The elementary transformations relate to four regular solids, and the underlying "ground-plan"-transformation relates to the dodecahedron. The dodecahedron is the "father" and the tetrahedron, cube, octahedron, and icosahedron are the children of the cosmic transformation-process.

## II. More Nothing

You see, until now, I have managed to say nothing about Kepler's *Six-cornered Snowflake*. But now I can no longer

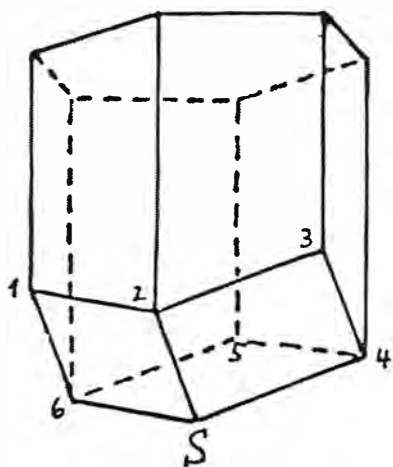
avoid entering into this little work. Hopefully, I shall succeed in finding essentially nothing.

Kepler investigates here, what is the "specific cause" of the fact that snowflakes always have the shape of a six-pointed star? What "action" generates from the "continuous stream" of water-vapor those "singular little stars" of precisely this form? Kepler does not give, as he promises in the beginning, an answer to this question! He can get by without doing this, only because he chooses not to simply solve this question, but instead to investigate it mainly for the methods to research and answer such type of questions. If Kepler had not done this, he would not have been able to stick to the "nothing."

The correct method is to find possible principles for the "action" which expresses itself in specific geometric forms. For example, Kepler looks at the rhombic form of the seeds of the pomegranate fruit. To explain this, material necessity is sufficient, because the seeds are compressed in the bounded space of the fruit, and the specific rhombic form results from the need for close packing.

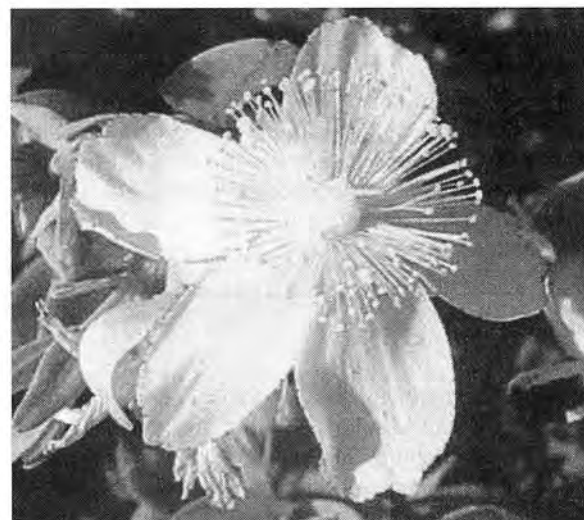
But the same geometric form can be found in the bottom of the honeycomb, where no compression can be assumed, and thus another explanation must be found. Here, the action implies that there is within the bee an instinct, which directs its action toward an aim. The bee itself does not know this aim, which the Creator embedded in its action, but man's reason is able to perceive and to know it: This form of the honeycomb minimizes the work needed to build it. Incidentally, in passing, Kepler explains to us the connections among the Final Cause, the Leibnizian terminology Final Cause/Efficient Cause, and the Principle of Least Action.





**Figure 5**  
**A HONEYCOMB CELL**

The bottom of the cell of a honeycomb has three rhombic faces. In this way, each face can be used very economically. The same is true for the bottom of the set of honeycombs lying on the opposite side. Three of these rhombic faces form one corner of Kepler's "small" rhomboid.



**Figure 6**  
**FIVE-FOLD SYMMETRY, CHARACTERISTIC OF LIFE**  
*In nearly all blossoms, there is five-fold symmetry, carrying "the colors of life," as Kepler said.*

In the case of the snowflake, unlike the pomegranate and the honeycomb, both of the above principles of action fail. In the clouds, for example, there can be no limitation of space; as for an instinct to act, there are no bees there. So what kind of water-ghost is it, that generates those snow-crystals up there? What kind of "instinct" does such a water-ghost have to follow?

I will not answer this exactly. I prefer to indicate what Kepler reports about the essential difference between six-fold and five-fold geometry, as it is expressed in flowers, for example. The basis of this five-fold geometry is the "golden proportion," implicit in the dodecahedron and the icosahedron. This beautiful form characterizes the "anima (soul) of the plants" and is an emblem of its "capability of procreating." The non-living snowflake expresses a six-fold geometry. But why this specific one?

The snow-crystals are generated exactly at the place, where there is a back and forth, a battle between cold and warm. Kepler mentions, in this regard, the six-cornered ice-crystals on broken windows of steam-baths in wintertime. Now I want to quote from thesis 8 of Kepler's *On the Safe Foundations of Astrology* (Von den gesicherten Grundlagen der Astrologie):

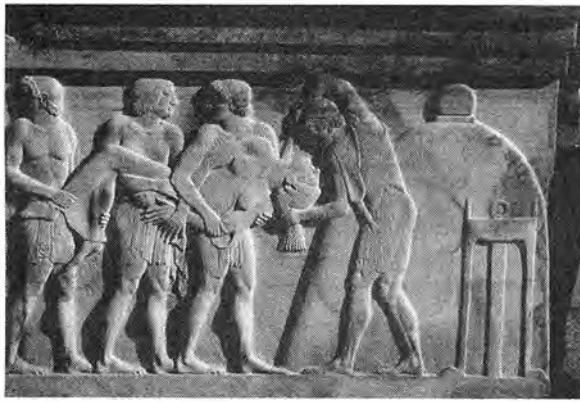
That everything that participates in the material is, as far as it participates in it, by its nature cold. However, everything that is by its potential warm, owes this quality to a living force, be it a force of itself or of that from which it originated.

So, Kepler says, the warmth rises from the quality of a "liv-

ing force." The coldness acts not by itself, but it is absence of living warmth, the same way that evil is only the lack of good.

But back to Kepler's *On the Six-Cornered Snowflake*, and there to a place where he nearly gives the answer about what the water-ghost *nix* does in creating six-cornered snowflakes. Kepler says:

I namely believe that warmth, which possessed the matter until then, is now overcome by coldness. As it acted until then in ordered fashion, so it now bends in its order to retreat and gives way and holds composure in those . . . six-fold ordered feathery structures . . . and takes care, not to be killed in action



**Figure 7**  
**THE DEATH OF POLYXENA**

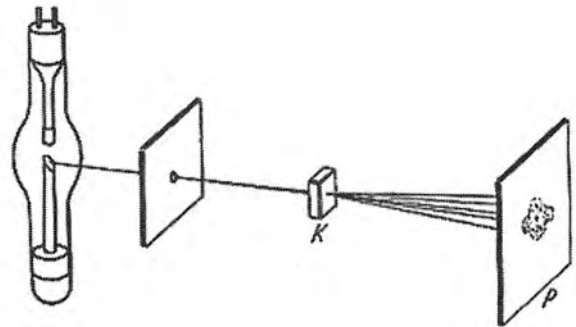
Kepler refers to the dignity of the death of Polyxena, the youngest daughter of the king of Troy, who was murdered by the Greeks after they conquered the city (an event depicted here). The poet Euripides reports her last words:

"Greeks, you who have destroyed my city, I will die ready. Nobody should touch my body, because I will courageously offer my throat. Leave me unbound and kill me! By the Gods! Leave me die as a free being! . . . In dying still she was concerned only that she would fall with dignity, concealing what has to be concealed from men's eyes."

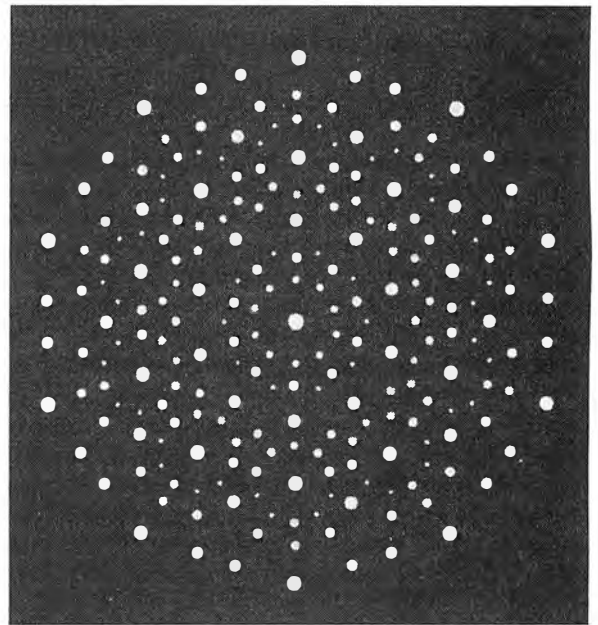
without honor and dignity.

Not without dignity! That is, for the commentators of Kepler's writings an absolute nothing, and for that reason, I have to say something about it. "Not without dignity": Doesn't this mean, that you are overwhelmed by a physical power, but still do not give up your essence? So, in acting with dignity, we see a higher principle, pointing beyond an individual existence. To act with dignity is possible only for a moral being who is capable of free will—man. Kepler knew this with certainty. So his metaphor expresses the idea that there must be a higher principle that connects warmth and coldness. Only this "connectedness" can explain that there is (in addition to the five-fold geometry, which is obvious in the "immediate design of the plant" and in the "play of form-giving reason") an ordered geometrical form of non-living matter, which we can see exemplified in the six-cornered form of the snow-crystal.

This explains why Kepler states, for example, in his *On the Safe Foundations of Astrology*: "Where there is matter, there is geometry!" This is a statement to which Plato also would subscribe. Aristotle, however, as Kepler explains in his *World Harmonics*, "cannot acknowledge the archetypal character and meaning of the quantitative figures [because] . . . he denies the creation of the world." The reason for this is that the geometric figures can be meaningful, only if there exists a "Creator, who created the matter." "Geometry," says Kepler, "gave God the images to shape the world."

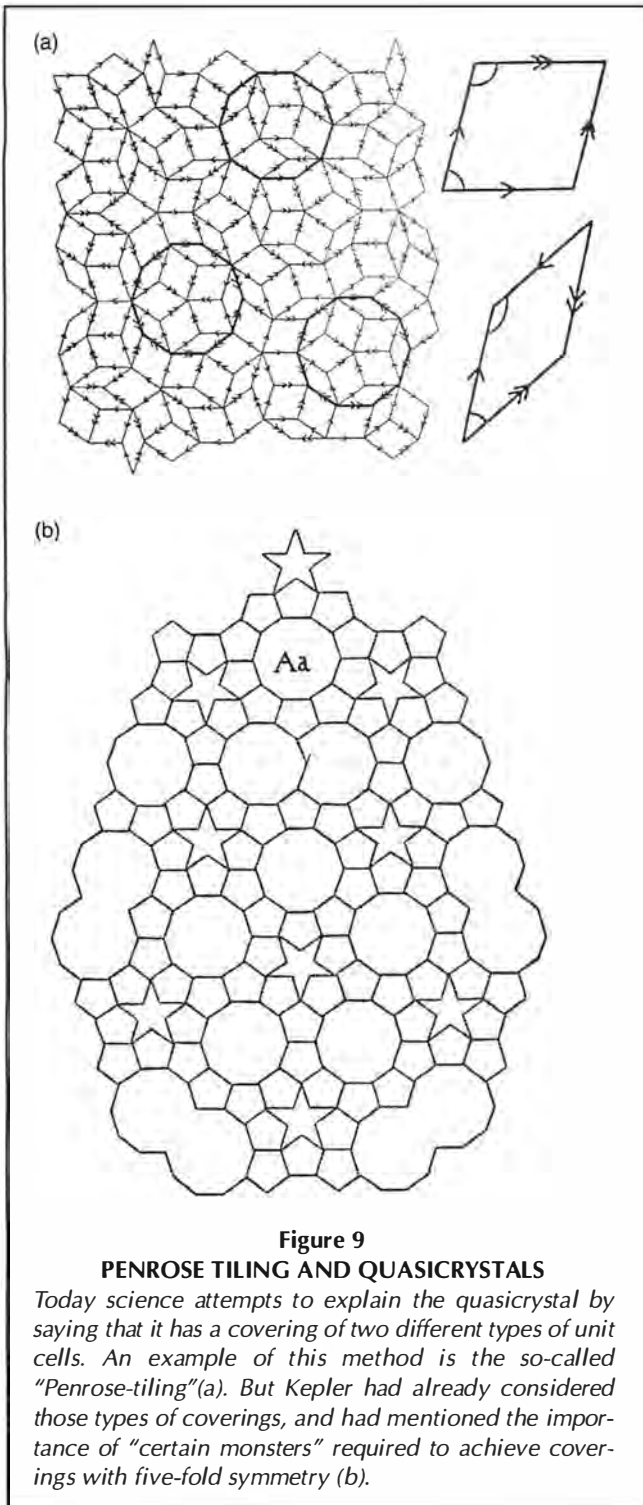


**Figure 8 (a)**  
**SCHEMATIC OF APPARATUS TO X-RAY CRYSTALS**  
On the suggestion of the physicist Max von Laue, in 1912 a crystal was investigated for the first time with X-rays. The resulting pictures showed symmetrically ordered spots of light. From the order of these spots on the screen, one can adduce the six-fold spatial order of the crystal.



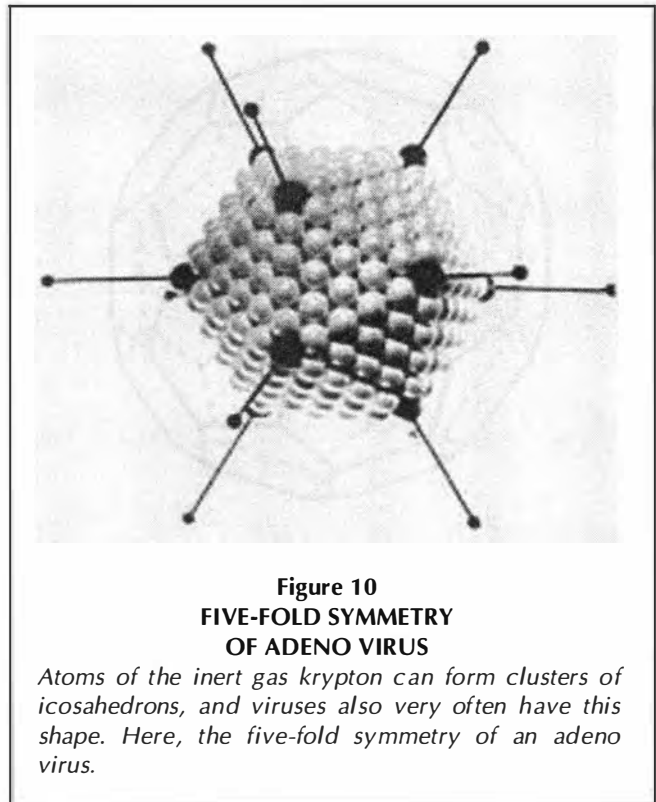
**Figure 8 (b)**  
**THE FORBIDDEN SYMMETRY OF QUASICRYSTALS**  
When, in 1987, for the first time X-ray images showed a five-fold symmetry within the crystal, it was called a quasicrystal, because theory forbids this kind of order for "normal" crystals.

This is no affront to God, no limiting of God. The intended action of creative reason is geometric! This is the "connectedness" of active reason and living, as well as non-living, matter, which we found earlier in the example of the instinct of the bee. In the bee, it expresses itself without the bee knowing it in a specific geometrical form, a form



expressing a Final Cause, associated with a least-action principle.

For the commentators of Kepler's *On the Six-Cornered Snowflake*, such an idea means totally nothing, because they think like Aristotle. They deny all cognitive processes, they admit nothing but the laws of "causality," and they explain everything else just as "chance" or as "result of sto-



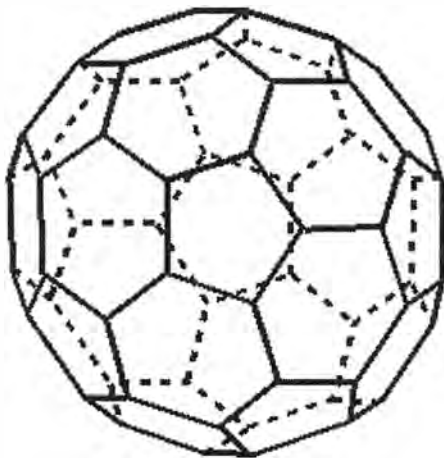
chastic processes." Then, having done this, they attempt to describe by "laws of evolution," "self-organizing structures," or "fractals," what they before condemned as unknowable.

In contrast, I believe to have found in Kepler's *On the Six-Cornered Snowflake* an explanation why the universe can be known by the creative process of human cognition: Because the essential characteristic of the universe, which Kepler metaphorically tries to express, is exactly the idea of the threefold-connected phase space—connecting in a unique way the qualitatively different principles of action of the noosphere, biosphere, and non-living matter. This is likely the real key to the nothing of Kepler's *On the Six-Cornered Snowflake*.

### III. Quasi Nothing

At the very end of his little work, Kepler states, that he has "knocked on the door of chemistry." Since that time, we have opened that door widely, stepped through it, and reached further doors behind it. Therefore, we can spin the thread of Kepler's investigation further, always taking care that nothing will be the result.

As mentioned above, some of Kepler's thoughts in the *Six-Cornered Snowflake* gave rise to an entire area of science known today as crystallography. This field of science investigates the kind of regular forms that fill Euclidean space completely, without any gaps. A generalization of Kepler's six-fold form was developed, and as Kepler had said, the difference of this shape from the five-fold form was found to be a very basic one: No crystal can have a five-fold symmetry. For many years we were able to "look into" crystals with strong X-ray lamps, and we have never found a five-fold crystalline



**Figure 11**  
**THE FULLERENE**

*The fullerene, the most simple of which contains 60 carbon atoms, can be conceived of as two-dimensional crystals in a space of constant positive curvature.*

structure.

Then, 15 years ago, something very surprising happened—something which could not be explained very well until today. While X-raying an aluminum-manganese alloy, whose crystallization had occurred extremely rapidly, a five-fold crystal geometry was found for the first time—something that mathematically should not be possible to exist. Solid bodies had been divided strictly into amorphous and crystalline, and now something new had appeared, which could be neither. The new substance could not be amorphous, because it showed a global internal order, yet it could not be a crystal, because of its forbidden five-fold geometry. This “impossible” thing was then named a quasi-periodic crystal or, for short, a “quasicrystal.”

When I saw a quasicrystal for the first time, I immediately thought of Kepler’s *World Harmony*, where he developed the concept of a quasicrystal (in Book II, Paragraphs 29-31). If one looks at “certain monsters” that Kepler used in his attempts to tile a plane surface with five-fold and ten-fold symmetric figures, one sees directly the “Penrose-tiling” used today to describe those quasicrystals. You see, Kepler is not only the founder of crystallography, but of a much deeper concept of matter.

The spatial order of atoms in quasicrystals is comparable to the decimal representation of a transfinite number, for example  $\pi$ . The number  $\pi$  expresses, the relation of the radius of a circle to its circumference, which geometrically defines  $\pi$  precisely as a number. If this actually infinite idea of  $\pi$  is expressed in the potentially infinite series of decimal figures, one obtains a one-dimensional quasi-crystal. This series of figures is not chaotically random, because it is defined by a “transcendent” geometrical idea; but it is also not regular in a repetitive way, as are the “number-crystals” created by the rational numbers. The question, however, remains, what kind

of “instinct” do the atoms of the quasi-crystal follow to orient to this “actual infinity”?

Since Kepler’s time, our possibilities of physical observation have improved tremendously. During the time of Kepler, there was not even a microscope, while today we can see down to the scale of atoms with the scanning tunnelling microscope. We can observe how atoms form clusters, and see how, for example, 13, 55, 147, 309, 561 . . . atoms form an icosahedron. We also can see directly that viruses have the shape of icosahedrons; for example the hepatitis-C virus or the inner core of the HIV/AIDS virus, which each forms an icosidodecahedron.

Shortly after the discovery of quasicrystals, in 1985, the so-called fullerenes were discovered. The most simple form of the fullerene consists of 60 carbon atoms, organized in such a way, that each one sits in a corner of a truncated icosahedron. The name of this figure was coined by Kepler, who continued his “research in quasi-crystals” with this figure (Book II, paragraph 28 of the *World Harmonics*). One can conceive of this order of 60 carbon atoms in this specific icosahedral structure as a type of crystal in specifically curved space; that is, in the surface of a sphere.

If I try to imagine which kind of *nix* is playing its tricks with these atoms, to lure them to “live” in specific geometries, I get the impression that matter in its smallest parts actually likes curved space very much. And it seems, that only if this living principle of curved space is overpowered from outside, do such small parts of matter “bend” in ordered fashion” and, not “without honor and dignity,” take on flat crystal-forms. If these small parts of matter get a chance to retreat, they still contain the trace of this curvature within them, and become, for example, those interesting quasicrystals.

One can, for example, also imagine that icosahedral clusters of 13 atoms are compressed like the seeds of the pomegranate, or as one can compress little balls of wax in the palm of the hand. This interaction from outside degenerates the symmetrically even distribution of the central angles of the clusters in such a way, that 6 of the 12 outer atoms are pushed into one plane, and 3 on top and 3 below it: In this way, the “curved” icosahedron-structure transforms into the crystal structure of closest packing, characterized by a lattice of parallel planes. Yes, one might even think that atoms like to organize in microscopic space in the highest multiplicity of regular orderings. If this were the case, they would prefer even negatively curved space, to be able to form seven-fold crystals, for example, and even more interesting ones.

But this is still nothing, compared to what kind of space the elementary particles might like to form, that is, the type of space inside the atoms. And it was Dr. Robert Moon, who stated, in the very sense of Plato’s *Timaeus*, that there we do find the order of the Platonic solids. Nothing follows.

*Ralf Schauerhammer is an editor of the German-language science magazine Fusion and a leader in the LaRouche political movement in Germany. He is co-author of The Holes in the Ozone Scare: The Scientific Evidence That the Sky Isn’t Falling, published by 21st Century. This article first appeared in the German-language Fusion, Winter 2002, and was translated by the author.*



# MAGLEV

## The New Mode of Transport For the 21st Century

by James Powell and Gordon Danby

**M**aglev is a completely new mode of transport that will join the ship, the wheel, and the airplane as a mainstay in moving people and goods throughout the world. Maglev has unique advantages over these earlier modes of transport and will radically transform society and the world economy in the 21st Century. Compared to ships and wheeled vehicles—autos, trucks, and trains—it moves passengers and freight at much higher speed and lower cost, using less energy. Compared to airplanes, which travel at similar speeds, Maglev moves passengers and freight at much lower cost, and in much greater volume. In addition to its enormous impact on transport, Maglev will allow millions of human beings to travel into space, and can move vast amounts of water over long distances to eliminate droughts.

In Maglev—which is short for MAGnetic LEVitation—high speed vehicles are lifted by magnetic repulsion, and propelled along an elevated guideway by powerful magnets attached to the vehicle. The vehicles do not

physically contact the guideway, do not need engines, and do not burn fuel. Instead, they are magnetically propelled by electric power fed to coils located on the guideway.

Why is Maglev important? There are four basic reasons.

**First**, Maglev is a much better way to move people and freight than by existing modes. It is cheaper, faster, not congested, and has a much longer service life. A Maglev guideway can transport tens of thousands of passengers per day along with thousands of piggyback trucks and automobiles. Maglev operating costs will be only 3 cents per passenger mile and 7 cents per ton mile, compared to 15 cents per passenger mile for airplanes, and 30 cents per ton mile for intercity trucks. Maglev guideways will last for 50 years or more with minimal maintenance, because there is no mechanical contact and wear, and because the vehicle loads are uniformly distributed, rather than concentrated at wheels. Similarly, Maglev vehicles will have much longer lifetimes than autos, trucks, and airplanes.

*The inventors of the world's first superconducting maglev system tell how magnetic levitation can revolutionize world transportation, and even carry payloads into space.*

*The Maglev 2000 can operate in the open air, or in underground tunnels. Using a low-pressure tunnel will make it possible to get from Los Angeles to New York in 1 hour.*

**Second,** Maglev is very energy efficient. Unlike autos, trucks, and airplanes, Maglev does not burn oil, but instead consumes electricity, which can be produced by coal-fired, nuclear, hydro, fusion, wind, or solar power plants (the most efficient source now being nuclear). At 300 miles per hour in the open atmosphere, Maglev consumes only 0.4 megajoules per passenger mile, compared to 4 megajoules per passenger mile of oil fuel for a 20-miles-per-gallon auto that carries 1.8 people (the national average) at 60 miles per hour (mph). At 150 mph in the atmosphere, Maglev consumes only 0.1 of a megajoule per passenger mile, which is just 2 percent of the energy consumption of a typical 60-mph auto. In low-pressure tunnels or tubes, like those proposed for Switzerland's Metro system, energy consumption per passenger mile will shrink to the equivalent of 10,000 miles per gallon.

**Third,** Maglev vehicles emit no pollution. When they consume electricity, no carbon dioxide is emitted. Even if they use electricity from coal- or natural-gas-fired power plants, the resulting CO<sub>2</sub> emission is much less than that from autos, trucks, and airplanes, because of Maglev's very high energy efficiency.

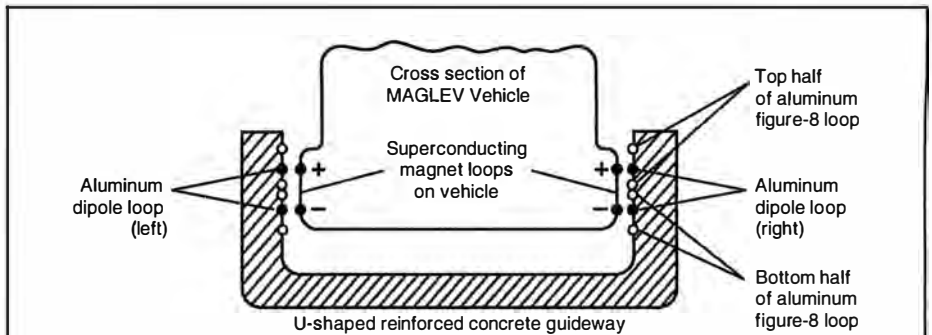
Maglev has further environmental benefits. Maglev vehicles are much quieter than autos, trucks, and airplanes, which is particularly important for urban and suburban areas. Moreover, because Maglev uses unobtrusive narrow-beam elevated guideways, its footprint on the land is much smaller than that of highways, airports, and railroad tracks.

**Fourth,** Maglev has major safety advantages over highway vehicles, trains, and airplanes. The distance between Maglev vehicles on a guideway, and the speed of the vehicles, are automatically controlled and maintained by the frequency of the electric power fed to the guideway. There is no possibility of collisions between vehicles on the guideway. Moreover, since the guideways are elevated, there is no possibility of collisions with autos or trucks at grade crossings.

#### How Does Maglev Work?

Maglev has been a dream since the early 1900s. Eile Bachelet proposed to magnetically levitate trains using attached alternating current (AC) loops above conducting metal sheets, such as aluminum, on the ground. Other ideas followed, based on conventional electromagnets and permanent magnets. However, all these proposals were impractical. Either power consumption was too great, or the suspension was unstable, or the weight that could be levitated was too small.

The first practical Maglev system was proposed and published by us in 1966.<sup>1</sup> It was based on Maglev vehicles carrying lightweight superconducting magnets that induced currents in a sequence of ordinary aluminum loops mounted along a



**Figure 1**

#### SCHMATIC OF MAGLEV VEHICLE IN U-SHAPED GUIDEWAY

*In this Maglev system, which is similar to the one in Japan, the vehicle has superconductor loops (approximately 600 kiloamp turns). The guideway has aluminum loops at normal temperature; their loop currents are generated by magnetic induction as vehicle loops move past them. The induced currents in "figure-8" guideway loops levitate and vertically stabilize the vehicle.*

*The left and right dipole guideway loops are electrically connected to form a circuit. Net flux and current in the circuit is zero when the vehicle is centered in the guideway. If the vehicle moves left from the center, the magnet force develops to push it back to the center.*

guideway. These induced currents interacted with the superconducting magnets on the vehicle, levitating it above the guideway. The levitated vehicle is inherently and passively stable against all external forces, including cross-winds, and the centrifugal forces on curves, whether horizontal or vertical. If a cross-wind tries to push the vehicle sideways, an opposing magnetic force is automatically generated that holds the vehicle on the guideway. If the vehicle is pushed down towards the guideway, the levitation force automatically increases, preventing contact. If an external force lifts the vehicle away from the guideway, the levitation force decreases, and the vehicle drops back towards its equilibrium suspension height.

The levitation process is automatic, as long as the vehicle moves at a speed above its lift-off speed. Below this speed, which is in the range of 20 to 50 mph depending on design, the finite electrical resistance of the aluminum loops on the guideway decreases the induced currents to the point where the magnetic force is too weak to levitate the vehicle. The vehicle is supported at low speeds by auxiliary wheels, or by locally powering the guideway. These lower-speed sections of guideway are very short and are needed only when a vehicle accelerates out of a station or decelerates into it.

Our 1966 paper sparked intense interest in Maglev in many countries. It was quickly realized that superconducting magnets made Maglev practical. Basically, superconducting magnets are extremely powerful and lightweight permanent magnets. Because they have zero electrical resistance, even when they carry currents of hundreds of thousands of amps, their power consumption is zero, except for a very small amount of electric power for the refrigerators which keep the superconductor at cryogenic temperature.

After our 1966 publication, Maglev programs started in the United States, Japan, Germany, and other countries. Sadly, U.S. Maglev development stopped in the early 1970s

(although it has since recommenced—more on that later), when the Department of Transportation decided that High Speed Rail and Maglev were not needed in the United States because auto, trucks, and airplanes would suffice for the indefinite future.

However, major development programs continued in Japan and Germany. Japan focused on superconducting Maglev, and now has a commercially ready passenger Maglev system based on our original inventions. Japan Railways operates Maglev vehicles at speeds up to 350 mph on their 20-kilometer guideway in Yamanashi Prefecture. Japan Railways vehicles operate in the open atmosphere and in deep mountain tunnels, both as individual units, and as linked sets of up to five units. A Japan Railways vehicle on the Yamanashi guideway is shown here.

The basic features of superconducting Maglev are illustrated in Figure 1 for a U-shaped guideway similar to the one in Japan. The set of passive, null-flux aluminum loops on the sidewalls of the guideway levitates and laterally stabilizes the moving vehicle. The vehicle is magnetically propelled along the guideway by a second set of aluminum loops on the sidewalls, called the Linear Synchronous Motor (LSM). The LSM loops are connected to a power line through electronic switches. When energized, the AC current in the LSM loops pushes on the superconducting loops attached to the vehicle, causing it to move along the guideway.

The LSM propulsion acts like a conventional rotary synchronous motor, except that it is linear instead of cylindrical. It pushes the Maglev vehicles at a constant speed that is fixed by the frequency of the AC current in the LSM loops, regardless of whether there are head or tail winds, or the vehicles are climbing or descending a grade. The spacing between vehicles always stays the same, making collisions impossible. Linear Synchronous Motor propulsion is very efficient—more than 90 percent of the electric power fed to the LSM loops ends up as drive power to the vehicles.

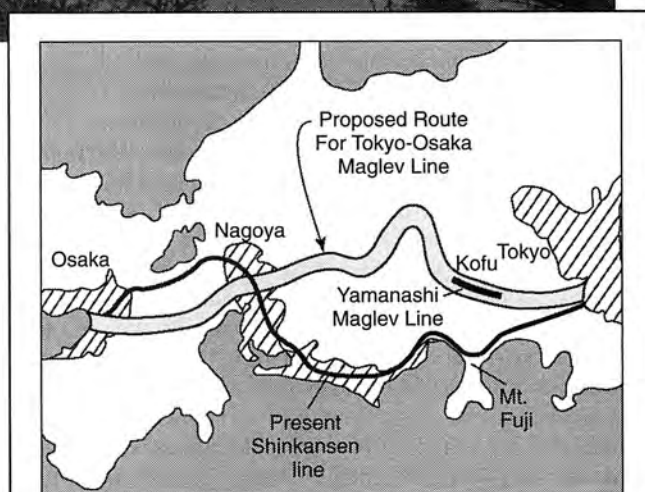
Japan Railways plans a 300-mile Maglev route between Tokyo and Osaka, to carry 100,000 passengers daily with a trip time of one hour (Figure 2). More than 60 percent of the route would be in deep tunnels through the mountains in the center of Japan. The proposed route would open this region, now sparsely populated, for development. Japan has spent more than \$2 billion in developing its Maglev system, and Japan Railways' Maglev vehicles have clocked over 200,000 kilometers on the Yamanashi guideway, carrying tens of thousands of passengers.

### Germany's Transrapid

Germany has followed a different path to Maglev. Instead of using superconducting magnets, the German Transrapid system uses conventional room-temperature electromagnets on its vehicles. The photo on page 46 shows how the electromagnets are attracted upwards to iron rails at the edges of a T-



Japan Railways

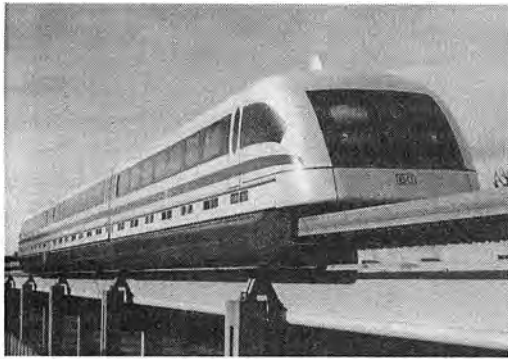


**Figure 2**  
**PROPOSED ROUTE FOR**  
**TOKYO-OSAKA MAGLEV LINE**

*The wide gray line is the 300-mile proposed Tokyo-Osaka line in central Japan. The thin line is the present railway line. The location of the existing Yamanashi Maglev line is shown (near Kofu).*

*Pictured above is a Japan Railways' vehicle on the Yamanashi guideway*

shaped guideway beam, providing the magnetic force needed to levitate the vehicle. However, in contrast to superconducting Maglev, which has an inherently stable magnetic levitation force, the Transrapid magnetic levitation force is inherently unstable. In superconducting Maglev, as the vehicle gets closer to the guideway, its magnetic repulsive force becomes greater, automatically pushing it away from the guideway. In electromagnetic Maglev, as the vehicle gets closer to the guideway, the magnetic attractive force becomes greater, automatically pulling it closer to the guideway. To prevent the



Transrapid

In the German Transrapid system, electromagnets are attracted upwards to iron rails at the edges of a T-shaped guideway beam, providing the magnetic force to levitate the vehicle.

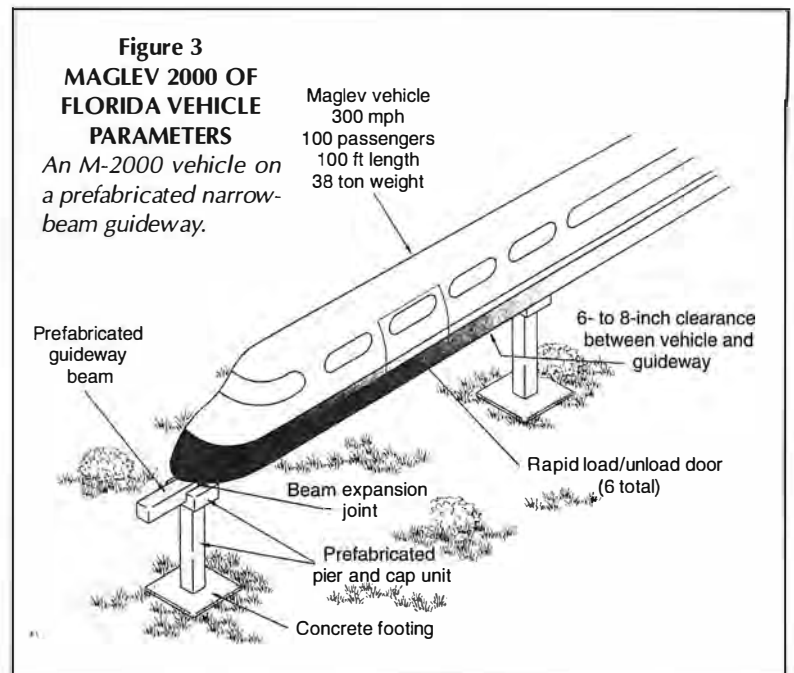
high-speed vehicles from being drawn up to and into contact with the guideway, and to overcome this inherent instability, Transrapid uses a servo control system that continuously adjusts the magnet current, on a time scale of thousandths of a second, to maintain a safe gap between the vehicle electromagnets and the iron rails on the guideway.

Because the electromagnets consume substantial amounts of electric power to generate their magnetic field, the gap between the Transrapid vehicle magnets and the guideway must be small, on the order of one-third of an inch. In contrast, vehicles that use superconducting magnets are 4 inches or more away from the guideway. Transrapid vehicles have also logged hundreds of thousands of kilometers on their test track in Emsland, Germany, and carried tens of thousands of passengers at speeds up to 280 mph smoothly and safely. The world's first commercial Maglev system went into operation recently in Shanghai, China. The 30-kilometer Transrapid route carries passengers between the center of Shanghai and its airport.

In our view, superconducting Maglev systems are better than electromagnetic or permanent magnet ones. The much greater clearance of the superconducting systems enhances safety and greatly mitigates the problems of snow and ice buildup in colder regions. Large clearance also permits greater construction tolerances, substantially reducing the cost of the guideway. Second, because a superconducting Maglev system can carry heavy trailers and freight as well as passengers, its revenue potential is much greater. Finally, the inherent very strong stability of superconducting Maglev systems helps to guarantee that safe operation is maintained at all times.

Implementing the first-generation Japanese and German Maglev systems has been hindered by the \$40 million to \$60 million per mile cost of their guideways. Assuming a daily ridership of 30,000 passengers—high for the United States—a \$50 million per mile Maglev route with a net revenue of 10 cents per passenger mile (ticket revenues minus operating and maintenance costs) would take 50 years to pay back its construction cost.

Highway and air transport systems have historically been—and continue to be—heavily subsidized by the U.S. government. Indeed, investment by government into more efficient



modes of transport increases the productivity of the whole economy, and thus pays for itself in added economic output. However, because of the current large budget deficits, the weak economy, and even weaker economic thinking, a new mode of transport like Maglev is unlikely to be supported by the present government unless it can pay back its cost within a few years. Moreover, if Maglev systems can be paid back quickly, they will attract private investment.

To achieve this fast payback capability, we are now developing a second-generation superconducting Maglev System that will be much less expensive to build, and that will produce much greater revenues by carrying piggyback trailers and automobiles. This second-generation system is described in the next section. Initial levitation tests of the system will be carried out this year at our Maglev-2000 of Florida facility, with funding from the U.S. and Florida Departments of Transportation.

### Moving People and Freight

The second-generation Maglev 2000 system achieves four major innovations over the first-generation Japanese and German systems:

- (1) Much lower guideway cost—\$12 million per mile, compared to \$40 million to \$60 million per mile.
- (2) Much faster payback times—5 years instead of 50, by carrying piggyback trucks.
- (3) Electronic switching of vehicles at high speeds from the main guideway to off-line stations for loading and unloading.
- (4) Ability to use existing, conventional railroad tracks for Maglev vehicles.

Key to these innovations are three fundamental Maglev-2000 inventions:

- Mass-produced, low-cost, prefabricated guideway beams and piers.
- Quadrupole magnets (with two pairs of North-South poles, at right angles to each other), which enable vehicles to



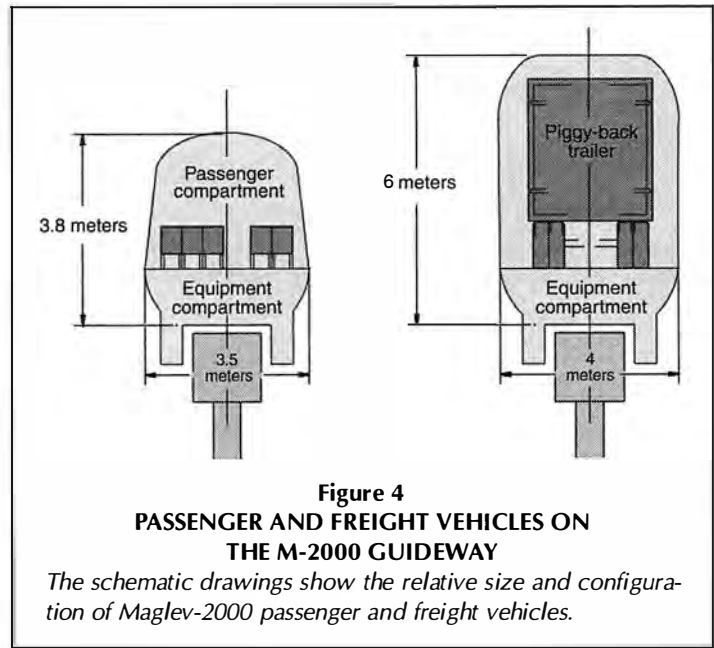
travel on, and smoothly transition between, both narrow beam and planar guideways.

- Electronic switching from the main guideway to secondary guideway, without any mechanical movement of the guideway's structures.

Figure 3 shows an M-2000 vehicle on a prefabricated narrow-beam guideway. The prefabricated, conventional, reinforced concrete box beams, with their attached aluminum-loop panels, are mass produced at low cost at a factory. The beams are then shipped from the factory, by truck or rail, to the Maglev construction site, along with the prefabricated piers. The only field construction required is the small poured concrete footings for the piers. Cranes lift the beams and piers into place, allowing a complete guideway route to be erected in a few weeks. The beams and piers can also be transported along finished portions of the guideway to the erection site, eliminating the need for road or rail transport. The projected cost of \$12 million per mile for the M-2000 elevated narrow beam guideway is based on our fabrication experience for full-size guideway components, including the beam. The projected costs do not include land purchase or modification of existing infrastructure.

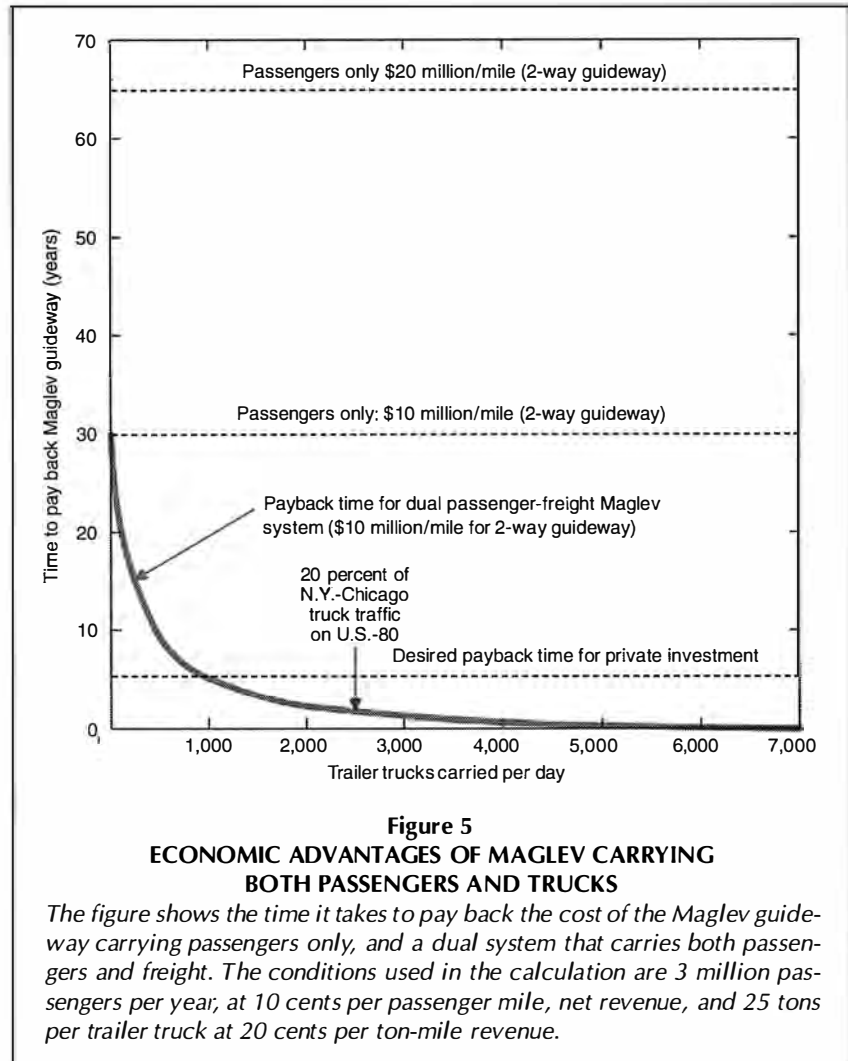
Maglev is usually pictured as a high-speed train for intercity passengers, or as a lower-speed system for urban transit. Although these are important applications, the big market for freight transportation in the United States is intercity trucking. The United States currently spends more than \$300 billion annually on intercity trucking, compared to only \$65 billion per year on intercity air passengers. The biggest intercity air passenger route, Los Angeles to and from New York, carries only about 10,000 passengers daily, while many U.S. Interstates carry 15,000 trucks per day, with some highways carrying more than 25,000 trucks daily. A Maglev route carrying 2,000 trucks per day—20 percent or less of the daily traffic—would take in as much revenue as a route carrying 100,000 passengers per day, which is 10 times greater than the largest intercity air passenger market in the United States.

The average haul distance for intercity trucks is more than 400 miles, with many travelling 1,000 miles or more. Using Maglev, truckers could pick up a load and drive it a few miles to the nearest station. The trailer would be put onto a Maglev vehicle (Figure 4), taking only a couple of minutes. At 300 miles per hour, the trailer could cross the country from California to New York in a few hours, instead of taking days by highway. After arriving at a station near its destination, the trailer would be unloaded and driven to the customer.



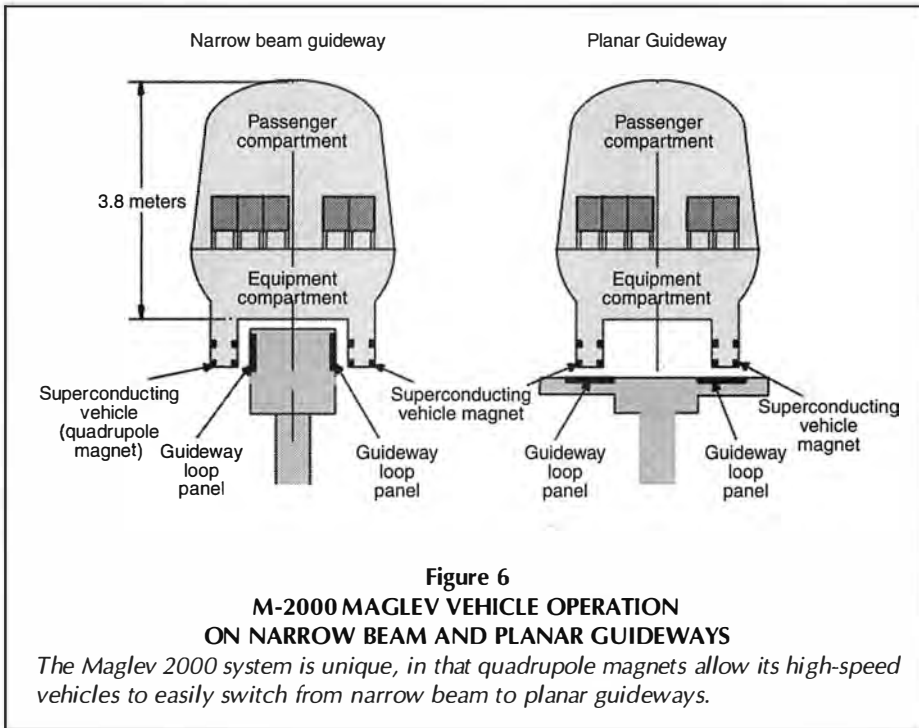
**Figure 4**  
**PASSENGER AND FREIGHT VEHICLES ON THE M-2000 GUIDEWAY**

*The schematic drawings show the relative size and configuration of Maglev-2000 passenger and freight vehicles.*



**Figure 5**  
**ECONOMIC ADVANTAGES OF MAGLEV CARRYING BOTH PASSENGERS AND TRUCKS**

*The figure shows the time it takes to pay back the cost of the Maglev guideway carrying passengers only, and a dual system that carries both passengers and freight. The conditions used in the calculation are 3 million passengers per year, at 10 cents per passenger mile, net revenue, and 25 tons per trailer truck at 20 cents per ton-mile revenue.*



mile for the Maglev 2000 guideway—well below the \$40 million to \$50 million per mile for the German and Japanese systems—paying back the guideway takes 30 years. However, by carrying 2,500 trucks daily—only 20 percent of the truck traffic between New York and Chicago—payback time drops to just three years. Short payback times will help attract massive private investment, aiding the rapid implementation of Maglev.

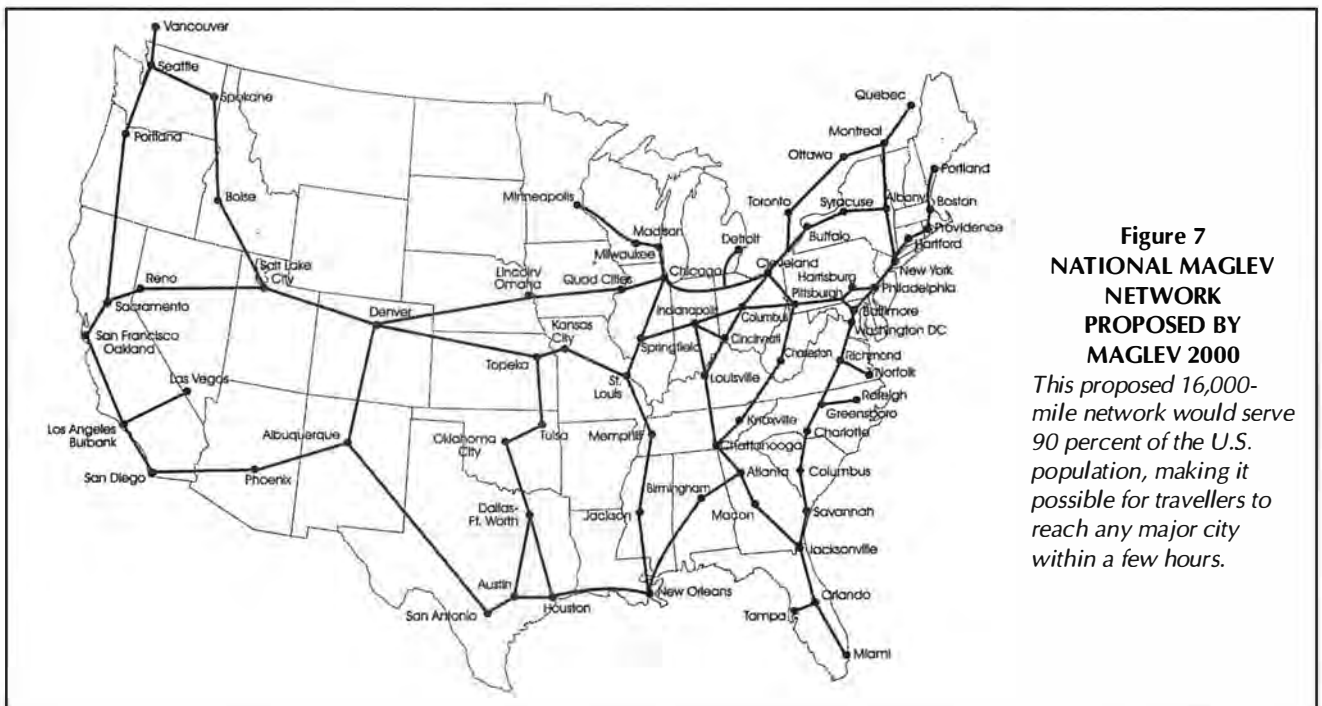
### Unique, High-Speed Train Switching

In addition to attractive economics, Maglev must be easily accessible and efficiently integrated with other modes of transport. Maglev 2000 is unique in its ability to electronically switch high-speed vehicles from one guideway to another, without having to slow down the trains, and

mechanically move sections of the guideway, as do the German and Japanese systems. The superconducting quadrupole magnets on the Maglev 2000 vehicles allow them to smoothly transition, back and forth, between narrow-beam and planar guideways (Figure 6). Most of the time, the vehicle rides on the low-cost, narrow-beam guideway, where the sides of the quadrupoles magnetically interact with aluminum loops attached to the sides of the beam to levitate and automatical-

Everyone would benefit: The shipper would pay less to transport his goods, and could shrink inventory by just-in-time delivery; the shipping company would make more money, and reduce wear and tear on its trucking fleet; and the drivers would not need to spend long, tiring hours on the road.

Figure 5 shows the economic advantage for Maglev to carry trucks as well as passengers. Even at \$10 million dollars per



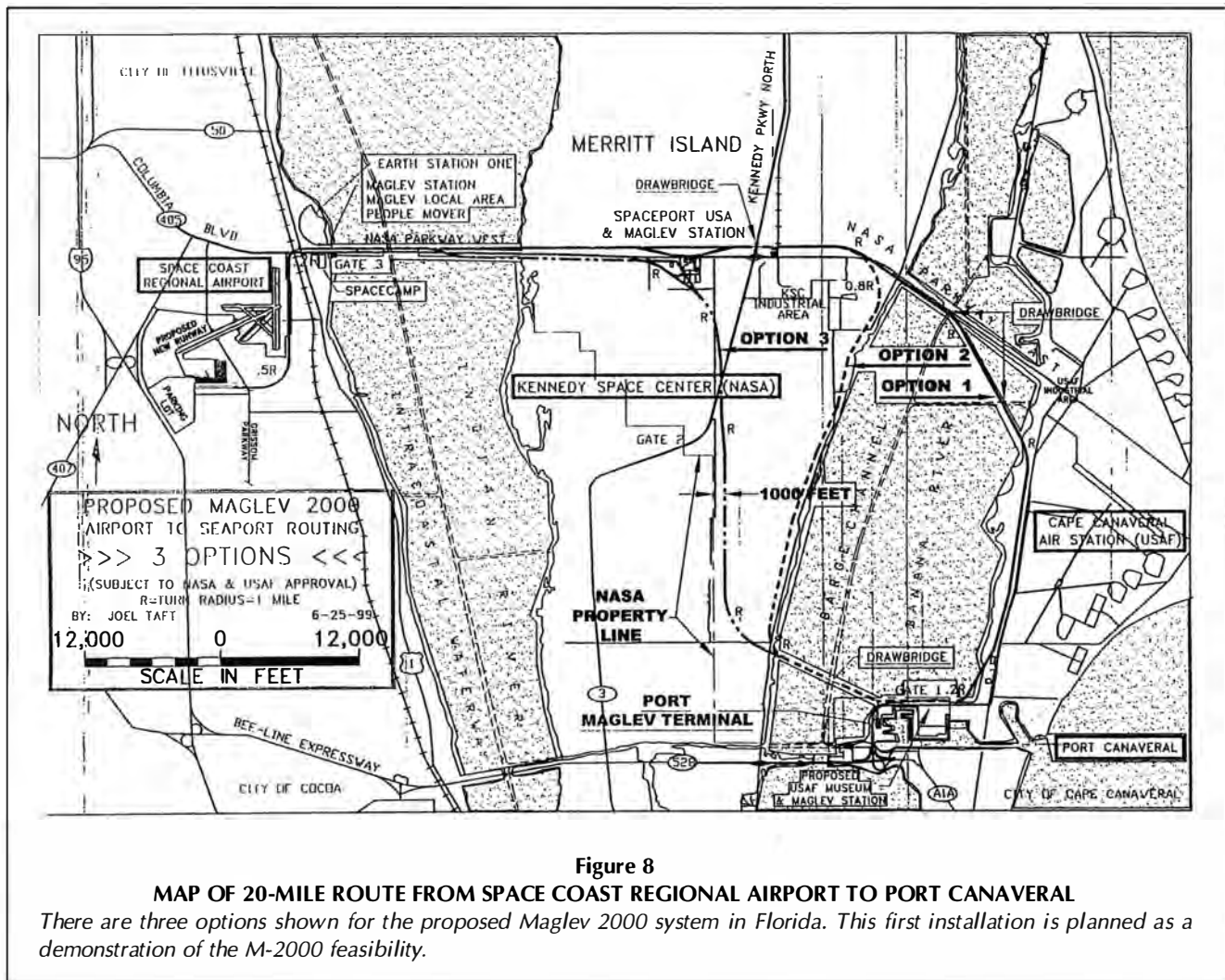


Figure 8

**MAP OF 20-MILE ROUTE FROM SPACE COAST REGIONAL AIRPORT TO PORT CANAVERAL**

There are three options shown for the proposed Maglev 2000 system in Florida. This first installation is planned as a demonstration of the M-2000 feasibility.

ly stabilize the vehicle. At locations where the vehicle may switch off the guideway, it transitions to a planar guideway, where the bottom of the quadrupoles magnetically interacts with the aluminum loops on the guideway beneath, levitating and stabilizing the vehicle.

At switch locations, the vehicle can either continue along the main guideway, or electronically switch, at full speed, to a secondary guideway that leads to an off-line station. The switch section contains two lines of aluminum loops. Depending on which line of loops is activated when the vehicle enters the switch, it can either keep going on the main guideway, or switch to the secondary one. The vehicle slows down on the secondary guideway, and stops at the station to unload passengers, or a truck, and pick up a new load. It then accelerates out of the station on the secondary guideway, to rejoin the main guideway at full speed.

Maglev-2000 systems can thus have many stations in an urban/suburban region, without sacrificing high speed and short trip times. Users would board a Maglev vehicle at a nearby station and travel at full speed to a station close to their destination, without stopping at intermediate stations. Unlike airports, which are limited to one or two locations in a given urban/suburban

region, making access difficult and time-consuming, Maglev can have 10 or 20 stations, or more, in a given region.

**A National Maglev Network**

In addition to easy access, for Maglev to be a major mode of transport, it must function as an integrated, interconnected network. Isolated, separate point-to-point Maglev systems could be useful, but would not provide the broad transport capability needed in the 21st Century. Figure 7 shows the National Maglev Network proposed by Maglev 2000. The 16,000-mile network, which would be built on the rights-of-way land alongside the U.S. Interstate highways, serves 90 percent of the population. Each of the metropolitan regions shown on the map would have multiple stations, as described above, with the result that 70 percent of Americans would be living within 15 miles of a Maglev station. Travellers could reach any destination in the United States, and the major cities in Canada, within a few hours of leaving their house, while trucks could cross the continent in less than 10 hours.

Travel on Maglev would be much more comfortable than by air. There would be no noise or vibration, no turbulence, and all passengers would ride in comfortable, first-class-type seating.

Maglev vehicles will cost much less than airplanes, and are not space constrained, so there is no need to jam passengers together to maximize loading. Because Maglev fares will be much less than those for air travel, passenger volume will be greater, allowing more frequent and convenient scheduling. Instead of one or two flights daily to a particular destination, there will be hourly, or even more frequent, Maglev departures.

The cost to construct the Maglev 2000 National Network is projected to be about \$200 billion. Although this is a large sum of money, it is equivalent to only two months of the annual U.S. transportation bill of \$1,200 billion, of which \$1,000 billion goes to autos and trucks. The transportation savings enabled by the U.S. Maglev Network would exceed \$100 billion annually, paying for the system in a couple of years. Unlike highways, autos, trucks, and airplanes, Maglev guideway and vehicles have no wear and tear, need virtually no maintenance or repair, and should last 50 years or more.

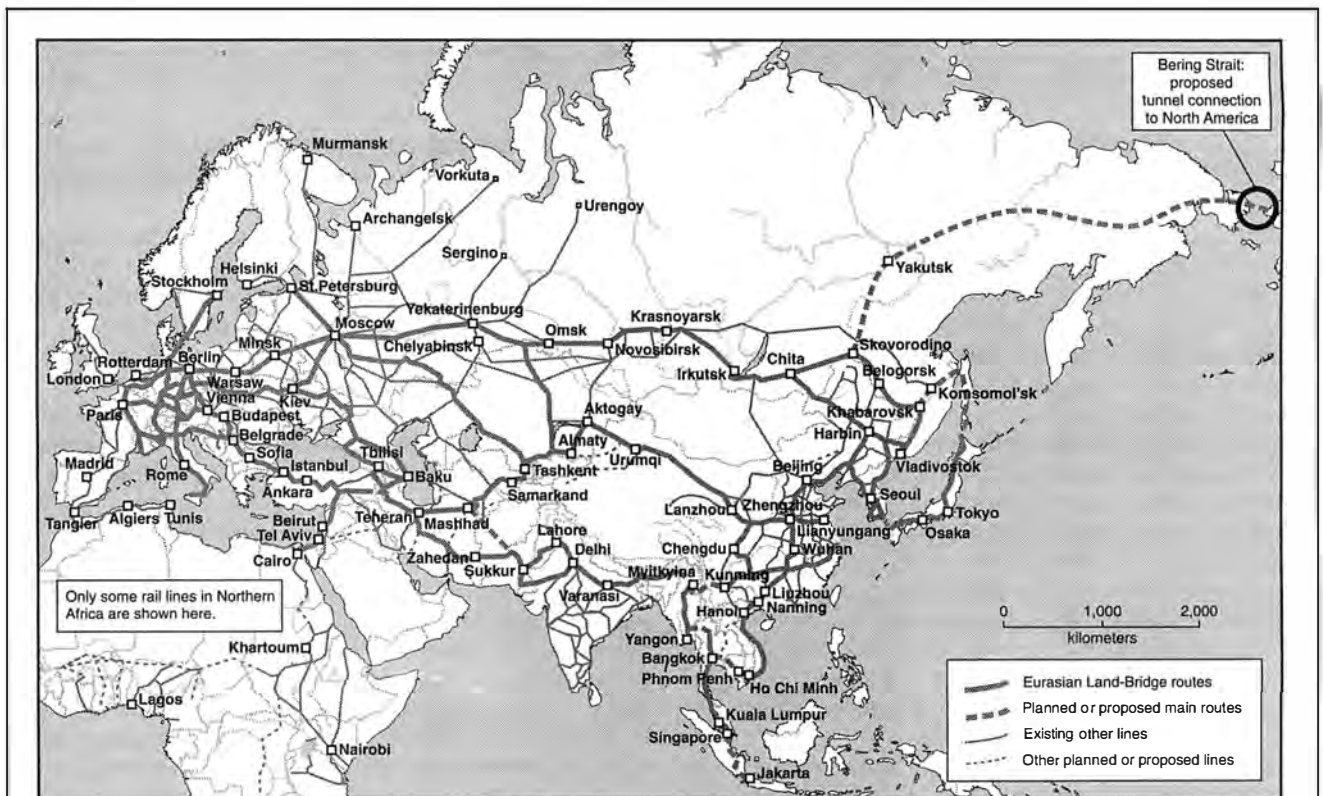
Maglev 2000 proposes to build the first U.S. Maglev System in Florida. Figure 8 shows the 20-mile route connecting the Port Canaveral Seaport and the Space Coast Regional Airport in Titusville, with an intermediate station at the Kennedy Space Port. The M-2000 line would carry cruise passengers to the seaport and visitors to the Kennedy Space Center; it would also demonstrate the transport of trucks and freight to and from the seaport. Once operating, the M-2000 line would act as a convincing demonstration of the practicality and desirability of Maglev transport, and would help spur the construction of

Maglev routes at many other locations in the United States. With a vigorous construction effort, the National Maglev Network could be in full operation well before the year 2020.

### The Great Trans-Siberian Land Bridge

The growing world economy requires the movement of ever larger amounts of people and goods over long distances. In particular, China, India, and other rapidly developing Asian countries, where most of the world's population lives, need modern, efficient, and low-cost transport systems that connect with Europe, America, and the rest of the world. Although most travellers to and from Asia now go by air, ships still move most of the goods. There are drawbacks for ship transport to Asia: The distances and travel times are very long, shipping costs are expensive, and ships consume a significant fraction of the world oil production.

As an example, the shipping distance between Japan and Europe is 12,000 miles via the Suez Canal (18,000 miles for the Cape of Good Hope route), and the trip takes several weeks. At 1-cent per ton mile, the shipping cost from Asia to Europe is \$100, or more, per ton of cargo. World shipping presently consumes approximately 7 percent of the world's oil production, a significant drain on oil resources. For much of the world's long-distance transport, Maglev can move goods much faster, cheaper, and with less energy use than can ships. For example, by using the existing Trans-Siberian railroad structure, Maglev could transport cargo between Europe and



Source: Executive Intelligence Review

Figure 9  
THE EURASIAN LAND-BRIDGE NETWORK

the Far East in only one day (compared to weeks by ship), at a much lower cost, and using much less energy.

Figure 9, taken from the *EIR Special Report* on the Eurasian Land Bridge,<sup>2</sup> shows the present railroad routes connecting the Far East with Europe and other Asian countries. The report describes how these routes, combined with a network of new rail lines, could help to develop and transform the region, by moving people and goods efficiently and cheaply. An interconnected Maglev system based on this railroad network can be quickly developed. The initial phase of the Maglev system would start with the existing 6,000-mile-long Trans-Siberian railroad. This Trans-Siberian route already carries substantial freight, approximately 100,000 Trailer Equivalent Units (TEUs) annually from Japan to Europe. At 25 metric tons per TEU, and 6,000 miles, this is equivalent to 15 billion ton-miles per year. Transport times are many days, however.

Building an elevated Maglev 2000 guideway along the Trans-Siberian route would cost \$60 billion, a formidable investment. However, there is a Maglev alternative that can enable a high-speed system at lower cost. This system uses existing railroad trackage to levitate high-speed Maglev vehicles, and can be built for only \$2 million dollars per mile. The M-2000 MERRI (Maglev Emplacement on Railroad Infrastructure) system attaches flat panels containing aluminum loops to the wooden or concrete ties of the existing trackage. The railroad can still operate conventional trains while the panels are being installed. After all of the panels are installed, Maglev operation on the resultant planar guideway can begin. The iron rails still remain in place, but they do not hinder Maglev operation. Using MERRI, Maglev vehicles would average 200 miles per hour across Siberia, travelling 6,000 miles in only 30 hours compared to a week by ordinary train. The energy amount and cost per trip would be modest—about 300 kilowatt hours and \$15 (at 5 cents per kilowatt-hour) per passenger, and 600 kilowatt hours and \$30 per ton of cargo. The total investment for the MERRI system is about \$15 billion, including installation of the planar guideway, stations, and an initial rolling stock of 400 Maglev vehicles. With its high speed capability, a single Maglev vehicle carrying 50 tons of cargo each way could transport 10,000 tons per year between the Far East and Europe.

Based on the *EIR Silk Road Report*, about 2 million tons of cargo is carried per year (1997 values) on the Trans-Siberian Railroad, assuming 25 tons per TEU, with the traffic expected to grow substantially. With 400 Maglev vehicles, the MERRI Trans-Siberian route could transport 4 million tons of cargo per year. At \$100 per ton, this would be a revenue of \$400 million annually. Revenues would then grow rapidly as shippers begin to appreciate the MERRI route's benefits.

Total annual freight traffic in the United States is 3.7 trillion ton miles, or more than 10,000 ton miles per person. High volumes of freight traffic are indispensable for good living standards, and reflect the necessary movement of foodstuffs, fuels, raw materials, and manufactured goods back-and-forth over long distances. Assuming similar per capita volumes of freight traffic, for the roughly 5 billion people who will live in the Eurasian continental land mass and its associated islands by the year 2050, freight traffic in the region will total more than 50 trillion ton-miles annually.

As traffic grows, the system would evolve, becoming larger and more capable. Other railroad routes would be converted to the MERRI system, new routes would be added, and dedicated Maglev guideways built. An intriguing possibility is the construction of a super-speed Maglev system across Siberia. In the super-speed Maglev-2000 system, described below, Maglev vehicles operate in an evacuated tunnel at 1/1,000th of normal ambient atmospheric pressure. Travelling at 2,000 mph, Maglev vehicles would make the 6,000-mile trip in only 3 hours, instead of the 30 hours for a Maglev vehicle in the open atmosphere. The energy cost for the trip would be less than \$1 per passenger, and about \$1 per ton of cargo.

The Trans-Siberian route is very appealing for super-speed Maglev. Because much of the terrain is flat and undeveloped, low-cost evacuated surface tubes can be used, instead of much more expensive underground tunnels, which are needed in regions having substantial populations and/or terrain changes. While the investment for a super-speed Trans-Siberian route is considerably greater than for a MERRI system—\$100 billion compared to \$15 billion—the increased traffic revenues and decreased operating cost would offset its greater cost.

There are many other places in the world where Maglev land bridges could aid economic development, and improve living standards. Some are outlined in the *EIR Silk Road Report*. As an example, the Trans-Siberian Maglev system could extend to the Bering Strait, where it would connect to an American-Canadian Maglev system. The Bering Strait is relatively narrow, about 50 miles across at the bridging point, and could be crossed by a bridge or tunnel. Both have been studied, and judged technically and economically practical.

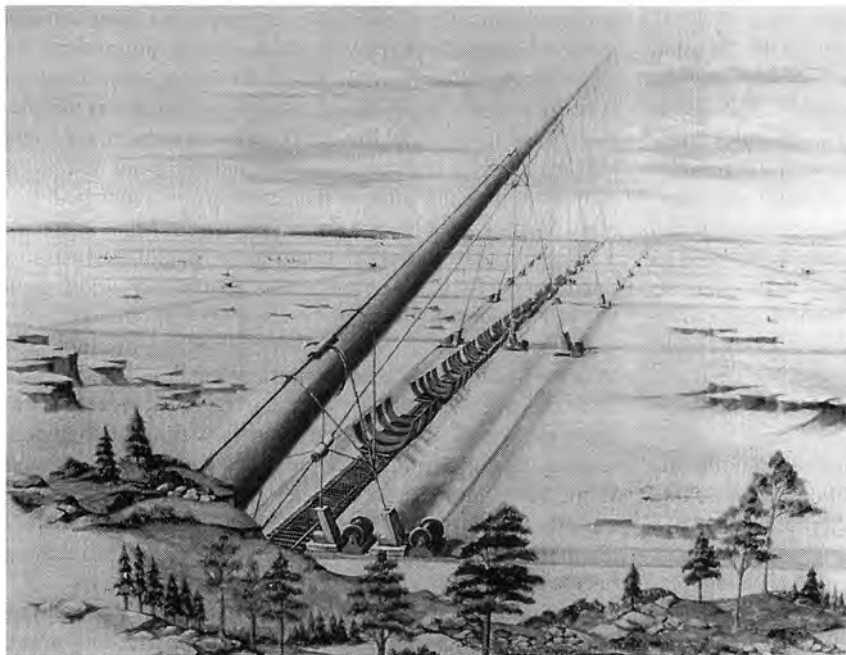
Integration of North America—and eventually South America, through Mexico, Central America, and the Isthmus of Panama—with Eurasia and Africa would connect almost all of the world with high-speed, low-cost, energy-efficient transport of people and goods. Africa would connect to Europe, via the proposed Gibraltar bridge, and through Egypt to the Middle East. Of the seven continents, only Australia and Antarctica would not be in the world Maglev Network, although there are plans for Maglev across Australia.<sup>3</sup>

When could a world Maglev Network come into being? Clearly, it would evolve over decades. Initial sections, like the U.S. National Network and the Trans-Siberian Maglev route could operate in 10 to 15 years. The full world Network would be in full operation by 2040 to 2050.

### **New York to Los Angeles in 1 Hour**

Because there is no mechanical contact or friction between levitated Maglev vehicles and the guideway, in principle the Maglev speed is unlimited. However, there always are limits. In the ambient atmosphere, Maglev vehicles are limited, by air drag and noise, to a maximum of about 300 miles per hour. In Maglev tests, Japan Railways has operated at 350 miles per hour. Because air drag increases as speed cubed, this is a practical limit. Noise emission increases as the seventh power of speed, so that noise would limit speed to about 300 miles per hour, even if air drag did not.

In low-pressure tunnels, however, Maglev speed is virtually unlimited, at least for transport on Earth. The only limitations are the straightness of the guideway, which is not a problem



**Figure 10**

**THE STARTRAM SPACECRAFT LAUNCH TUBE**

*This artist's illustration shows the lower end of the launch tube, with its attached tethers, as it leaves the ground. When it reaches the upper end of the launch tube, the spacecraft exits into the low-density atmosphere.*

for underground tunnels, and centrifugal effects, which are important only when close to orbital velocity, that is 8 kilometers/second (18,000 miles per hour).

At 2,500 miles per hour, travel time from New York to Los Angeles is only 1 hour. The energy expenditure per passenger would be negligible, about the equivalent of one quart of gasoline. In contrast, an airline passenger expends almost 100 gallons of jet fuel for the same trip. The reasons for the difference are simple. An airliner continuously burns fuel to stay aloft and overcome air drag, while the Maglev vehicle expends virtually no energy after it reaches cruise speed in the low-pressure tunnel (There is a small magnetic drag caused by the resistive losses in the aluminum guideway coils, but this is taken into account by the quart of gasoline.) Moreover, virtually all of the kinetic energy which the Linear Synchronous Motor (LSM) imparts to the Maglev vehicle when it accelerates to cruise speed, is recovered when the vehicle decelerates to stop at its destination. During deceleration, instead of acting as a motor, the Linear Synchronous Motor functions like a generator, converting the kinetic energy of the vehicle back into electricity, which is fed back to the electric grid.

The concept of super-speed Maglev in low-pressure tunnels has been studied over the last 20 years. The proposed Swiss Metro System would operate Maglev vehicles in low-pressure tunnels through the mountains. The planned Japan Railways 300-mile-long line between Tokyo and Osaka has 60 percent of the route in deep tunnels. The line could be built for low-pressure Maglev, although the relatively small time savings,

that is, 20 minutes out of the nominal trip time of one hour, might not warrant the additional tunnel cost.

Tunnelling costs are currently high, but not impractically so. Tunnels cost on the order of \$30 million per mile in competent rock. The U.S. Superconducting Super Collider facility, for example, planned a 45-mile tunnel for the superconducting magnets that confined the 10-trillion electron volt colliding particle beams. Several miles of Superconducting Super Collider tunnel were excavated using a tunnel-boring machine. As tunnelling technology advances, costs should drop, making super-speed Maglev more economical. At an average of \$10 million per mile for a 15-foot diameter tunnel, a two-tunnel Maglev system between New York and Los Angeles would cost \$50 billion. Intermediate stops at Cleveland, Chicago, and Denver would connect to the 300-mph open air National Maglev Network, allowing travellers to reach all the major metropolitan areas in the United States in a few hours. Although the National Network will operate first, super-speed Maglev will eventually connect

the main Network hubs, as an ultra high speed overlay.

Super-speed Maglev technology is similar to, and actually simpler than, the open-air technology. There are no wind or weather problems, vehicle levitation and stability is not affected by vehicle speed changes, there are no curves, and no need for Linear Synchronous Motor propulsion on most of the guideway, because magnetic drag at cruise speed is very small.

**StarTram: Riding Maglev into Space**

So far, space travel has been a big disappointment—at least from the perspective of the millions of people who want to visit hotels in space, and jet to the Moon, Mars, and beyond. We ordinary folk have to be satisfied with television shots of the astronauts in the space station, and tiny robots looking down on the moons and planets of the Solar System. In many ways, we have lost ground since the 1960s and 1970s, when astronauts drove Rovers on the Moon, hit golf balls, and brought back gobs of Moon rock.

The cost of getting into space has not come down much over the last 40 years. It still costs \$5,000 to put a pound of payload into Low Earth Orbit, and much more to land it on the Moon. As for Mars—forget it. This is not surprising. Despite repeated attempts to build cheaper rockets to reach orbit, these rockets remain very complicated and expensive. Unfortunately, this is inherent. Payload fraction is small, only a few percent, and the engines and structure are stressed to their limits. If a person is fortunate enough, and willing to pay \$20 million for the trip, it is possible to spend a few days in

orbit.

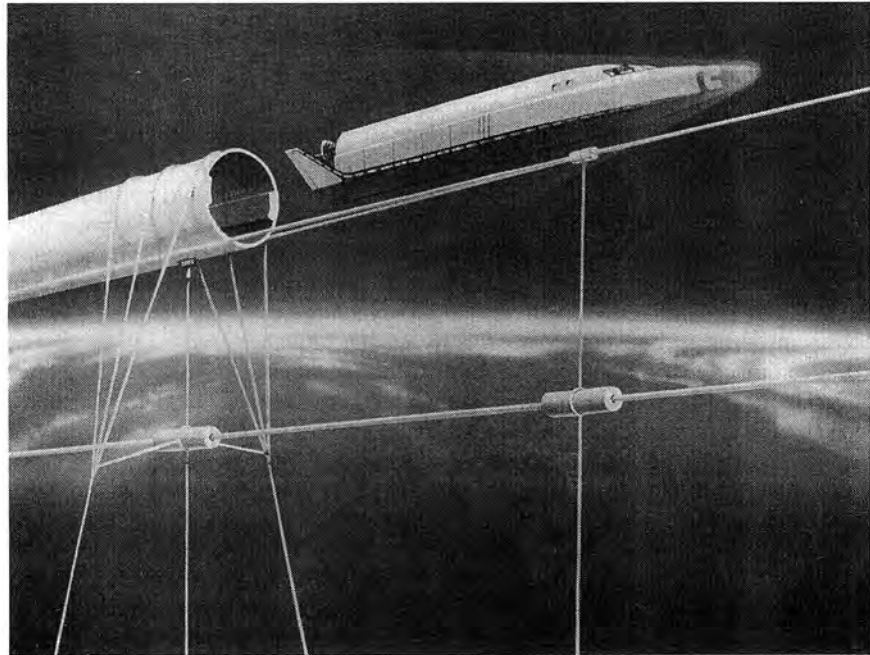
There is a better way. The cost of the energy to reach orbit is only 30 cents per pound, if one could do it efficiently without using a rocket. The StarTram Maglev system is that better way. By using electric energy to propel and accelerate spacecraft, Maglev can achieve speeds of 8 kilometers per second or more, enough to go into orbit or reach the Moon, without needing propellant. This greatly reduces the weight and cost of the spacecraft and makes the launch cost very low. Five kilowatt hours of electrical energy, (at an average cost in the U.S. of 6 cents per kilowatt hour) is equal to the kinetic energy of a pound of material travelling at 8 kilometers per second, the speed of an object in Low Earth Orbit.

There is a constraint and a problem in using Maglev to launch into space, however. The constraint is relatively minor, but the problem is major. First, the constraint: To reach super speeds, the acceleration process must take place in a low-

pressure environment over a long path. As described in the previous section on the Los Angeles to New York super-speed Maglev system, Maglev vehicles can travel at super speeds in low-pressure tunnels. The length of the tunnel needed to reach 8 kilometers per second will depend on the acceleration rate. For human passengers subjected to an acceleration of 2 g (2 times the Earth's gravity), an 800-mile long tunnel is required; for unmanned cargo craft, which could accelerate at 30 g without damage, a 60-mile tunnel is sufficient. Even at \$30 million per mile of tunnel, the amortized cost of a Maglev tunnel per pound of payload delivered to orbit would be small—less than the cost of energy.

The major problem, that of leaving the low-pressure tunnel and entering the atmosphere, is not as easily solved, unfortunately. At 8 kilometers per second, atmospheric heating and drag forces would quickly destroy the spacecraft, even if it entered the atmosphere at high mountain altitudes. However, there is a solution to this problem. A low-pressure Maglev launch tube, termed StarTram, can itself be magnetically levitated to extremely high altitudes—high enough that the atmospheric heating and drag forces, produced when the spacecraft leaves the tube and enters the atmosphere, become acceptable. At an altitude of 70,000 feet (about 13 miles), for example, atmospheric density is only 5 percent of the sea level value; at 105,000 feet (20 miles), it is only 1 percent. At such altitudes, today's spacecraft structures are strong enough to survive the heating and drag forces, without compromising the health and safety of passengers and cargo.

Levitating the StarTram launch tube to such altitudes, although a challenging task, is quite feasible. Large magnetic levitation forces, for example, several tons per meter of tube length, can be



**Figure 11**

**A SPACECRAFT LAUNCH IN LOW-DENSITY ATMOSPHERE**

*Artist's illustration of a StarTram launch.*

produced by the repulsion force between a set of superconducting cables attached to the tube, and a second set of superconducting cables located on the ground beneath. The two sets of cables carry oppositely directed supercurrents, generating a magnetic levitation force that substantially exceeds the weight of the launch tube and its cables. To hold the StarTram launch tube at a stable equilibrium height, lightweight high-strength tethers (Kevlar or Spectra) are attached to it and anchored at ground level. Figure 10 shows the lower end of the launch tube, together with its attached tethers, as it leaves the ground and ascends upwards. Using a combination of vertical and angled tethers, the launch tube is held in place even in the presence of high winds. The length of the tethers along the launch tube depends on what is needed to keep the tube at the proper angle, as it is pressed upward by the repulsive magnetic force.

The magnetic levitation force is very large, even at high altitudes. For example, if the launch tube cables carry 30 megamps of supercurrent, and the ground cables carry 100 megamps, the magnetic levitation force is 3 metric tons per meter of launch tube, at a vertical separation of 20 kilometers (66,000 feet) between the tube and ground. The levitation force increases with decreasing separation distance, being 6 metric tons per meter at 10 kilometers separation.

After the spacecraft reaches launch speed in the low-pressure Maglev tunnel located at ground level, it transitions to the StarTram launch tube, in which it coasts upwards to the release point in the upper atmosphere. Upon reaching the upper end of the launch tube, the spacecraft exits through the open end into the low-density atmosphere (Figure 11). The interior of the launch tube is kept at low pressure by a combination of auxil-

ary systems. These include a mechanical shutter that opens just before the spacecraft enters the launch tube, gas jet ejectors that start up when the shutter opens, and a magnetohydrodynamic (MHD) pump that expels any residual air that leaks past the gas jet ejector system. (A radiofrequency source ionizes the air in the MHD pump). Turbo molecular pumps supply additional pumping to help maintain low pressure in the launch tube.

After entering the atmosphere, the spacecraft coasts upwards through the small amount of residual atmosphere to orbital altitude, where it makes a small  $\Delta V$  (velocity change) burn to finalize the orbit. Depending on launch speed, the spacecraft can go into Low Earth Orbit, Geosynchronous Orbit, or any orbit in between. With slightly greater launch speed, it can reach the Lagrange points, or the Moon. As illustrated in Figure 11, the spacecraft would launch with its wings folded. For the return to Earth, the wings would deploy for atmospheric braking. Because a Maglev spacecraft does not use propellant, and its launch energy cost is virtually zero, weight is not an issue. Thus the StarTram spacecraft can be much stronger and more rugged, with much better thermal protection, than the Space Shuttle.

All of the technology for StarTram is available. The superconductors, cryogenics, refrigerators, tethers, Maglev guideways, and spacecraft can be built with materials that already

exist and are in use. This contrasts to the Space Elevator Concept, which requires structural materials that are 100 times stronger than any now in existence.

The table (this page) summarizes the parameters and operational capabilities for StarTram. A single StarTram facility could launch a million tons of cargo, along with hundreds of thousands of passengers, per year into space. Flying into space would not cost much more than it now takes to fly around the world. If human beings really want to have hotels and manufacturing in space, a robust defense against asteroids, solar power satellites, colonies on the Moon and Mars, and so on, StarTram is the way to go.

### Maglev, Oil, and the World Economy

Modern transport is the indispensable backbone of a high living standard. Without autos, trucks, airplanes, railroads, ships, and pipelines, we would retreat to subsistence on small patches of land, farming for produce and gathering wild foods to sustain life. In turn, oil is the indispensable backbone of modern transport. Without it, we would not have autos, trucks, and airplanes. Coal-fired railroads and ships could still operate, but much less capably.

The amount of oil in the world is limited. The presently known total world oil resources are only about 1 trillion barrels, about 30 years' worth at the current consumption rate of 80 million barrels per day. As living standards improve, and the world economy grows, the demand for oil will increase, resulting in an ever-greater rate of consumption. It is not possible to know precisely when the world will reach the point when oil runs out, because the date will depend on factors like the amount of oil deposits yet to be discovered, how difficult and expensive it will be to extract them, and how rapidly the world economy grows.

There is a clear fork in the road here. If the world continues to rely on oil for transport, its economy cannot grow much beyond the present level. In fact, the economy will shrink, and living standards will fall, as oil production declines. To maintain a growing world economy and an increasing standard of living, it will be necessary to shift to new modes and energy sources for transportation. New energy sources are possible, but there are limits. Hydrogen has been proposed as a long-range fuel for transport. However, enormous amounts of electricity would be needed to manufacture the hydrogen that would be needed, if it were to become the major energy source for transport.

The United States currently burns approximately 5 billion barrels of oil per year for transport, which is approximately 70 percent of total U.S. usage. To produce the equivalent energy from hydrogen fuel would require 10 trillion kilowatt hours of new electric power—a factor of 3 greater than current U.S. electric generation. To meet the 2020 world demand for

#### STARTRAM OPERATIONAL PARAMETERS

##### Spacecraft

Launch velocity	8 km/sec (to LEO orbit)
Launch altitude	70,000 feet (enter atmosphere)
Payload to orbit	70 metric tons/100 passengers
Gross take-off weight	200 metric tons
Deceleration @ atmospheric entry	1.7 g
$\Delta V$ loss through atmosphere	0.05 km/sec (from entry to orbit)

##### Acceleration Tunnel

Length	1,280 km (800 miles)
Acceleration level	2.5 g
Time in tunnel	5.3 minutes

##### Launch Tube

Length	280 km (175 miles)
Launch angle	5 degrees (at exit point)
Centripetal acceleration	2.5 g
Time in tube	0.6 minutes
Superconductor current (tube)	14 megamps
Superconductor current (ground)	280 megamps
Magnet levitation force (70,000 ft)	4 metric tons/meter

##### Facility launch rate and costs

Spacecraft launch rate	1 per hour
Number of flights per spacecraft	150 per year
Spacecraft in fleet	60
Tons/year cargo to orbit	500,000
Passengers/year to orbit	200,000
Cost per kg of cargo to orbit	\$20 (capital + operating)
Cost of round trip passenger to orbit	\$13,000 (capital + operating)
Capital cost of facility	\$60 billion (incl. spacecraft)
Service/amortization lifetime	30 years



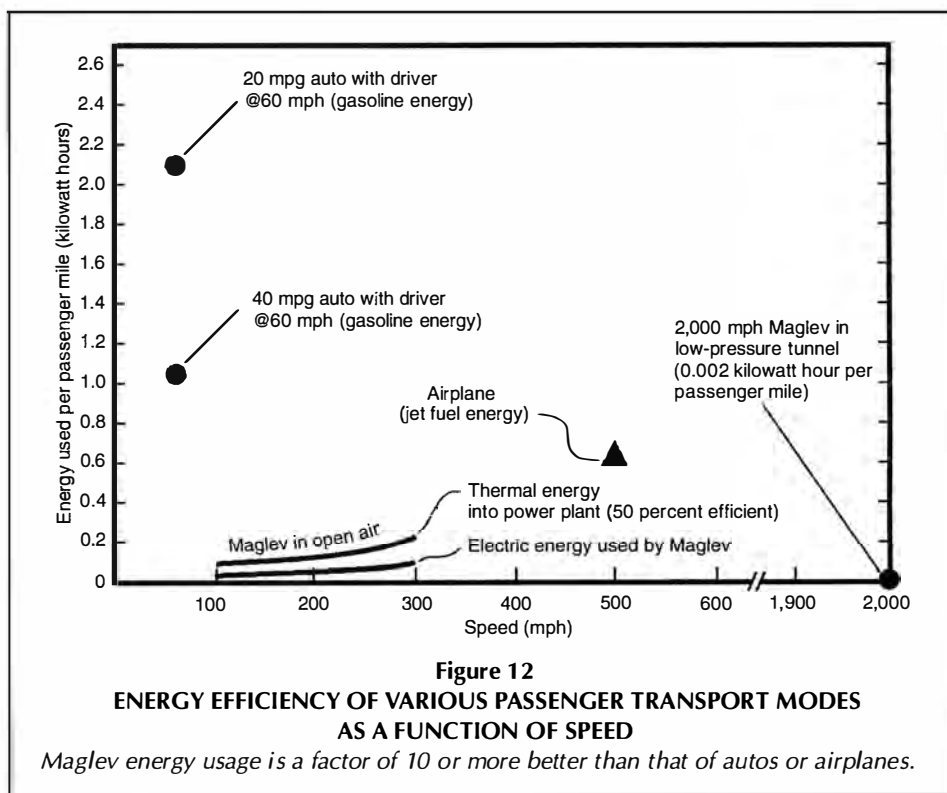
hydrogen fuel as a replacement for oil, would require constructing new electric generating capacity equivalent to 10 times the present world capacity. This is not a credible scenario. Hydrogen can be produced from coal, but the resultant CO<sub>2</sub> emissions would be much greater than those released by burning oil. Accordingly, hydrogen fuel does not appear to be a major practical solution for meeting the massive transport needs in the 21st Century.

Maglev, because it uses electric energy with very high efficiency, can meet 21st Century transport needs in a practical, energy efficient way. Figure 12 compares the energy efficiency per passenger mile by Maglev, autos, and airplanes. Maglev energy usage is a factor of 10 or more better than autos and airplanes. The total annual passenger traffic in the United States—autos, air and rail—is 2.5 trillion

(2,500 billion) passenger miles. If all this travel were by Maglev at an average speed of 200 mph, the total electric energy use would be only 100 billion kilowatt hours, which is about 3 percent of the 3,700 billion kilowatt hours currently generated in the United States. The total annual freight traffic in the United States—trucks, rail, oil pipelines, and air—is 3.7 trillion ton-miles. Moving all freight by 200-mph Maglev would consume an additional 10 percent of current U.S. electric generation.

Moving all passengers and freight by Maglev would save more than 5 billion barrels of oil annually, or about 70 percent of our current consumption. The dollar savings in the costs of the crude oil, refining, and distribution would be enormous. At a savings of \$1 per gallon of current oil consumption, the nation's transport bill would be reduced by \$200 billion annually, far more than the cost of the electrical power to operate the Maglev. At the U.S. average production cost of 6 cents per kilowatt hour, only \$30 billion of electric power would be needed annually for the Maglev operation. In practice, of course, Maglev will not be the sole mode of transportation in the United States, so that the actual economic and energy benefits will be somewhat less than described above.

Clearly, it will take time to transition from the present auto, truck, and airplane-dominated transport system to a Maglev-dominated system. Moreover, because Maglev will never completely replace autos, trucks, and airplanes, it will operate in concert with them in multi-modal transport patterns. For example, Maglev will carry trucks for the bulk of their intercity travel, using the highway for local pickup and delivery. Similarly, passengers will be able to drive their autos to a Maglev station, and travel hundreds of miles with their car on a Maglev vehicle to a station near their destination, finishing



**Figure 12**  
**ENERGY EFFICIENCY OF VARIOUS PASSENGER TRANSPORT MODES AS A FUNCTION OF SPEED**

*Maglev energy usage is a factor of 10 or more better than that of autos or airplanes.*

their trip on the highway. The wear and tear on their automobiles would be much less, the travel time much shorter, the cost much smaller, and the trip much safer.

The benefits of improved mobility, greatly reduced energy consumption, freedom from having to depend on ever-shrinking oil resources, and the economic savings outlined above for the United States, will apply to the entire world, making Maglev the major mode of transport in the 21st Century.

#### **The Maglev 2000 Water Train—Fresh Water for the World**

Maglev can help solve the world water shortage, by transporting fresh water from areas where it is plentiful, to areas where it is scarce. Water is the most critical natural resource problem facing the world today. Hundreds of millions of people lack sufficient clean water for drinking, washing, and farming, and the situation is growing worse, especially in Africa and Asia, where water tables are dropping as a result of over-pumping and droughts. In the United States, many regions are running out of water, including the Southwest, California, and the High Plains States. Even in the water-rich East, areas like Florida, Atlanta, and others have cut back on water consumption. World population is projected to grow from the present 6 billion to more than 9 billion by the year 2050, with much of the growth in regions that are already water short. This increase in population will require hundreds of trillions of gallons of new water annually. Experts believe that disputes over water rights could spark many new wars and conflicts in the coming decades.

Desalination is often proposed as the solution for future water shortages. Unfortunately, because it is expensive and energy intensive, it can supply only a small fraction of future world water needs. Desalination costs about \$6 per 1,000 gallons of

fresh water produced, and consumes approximately 400 kilowatt hours of thermal energy. To supply all of the projected new needs for fresh water in 2050, using present desalination technology, would require \$3 trillion, 10 percent of current world GNP, and virtually all (100 percent) of current world energy usage. This is clearly impossible.

Some improvements in desalination technology appear possible. Using low-cost nuclear energy, instead of expensive fossil fuels, for example, would significantly reduce the desalination cost. Studies of nuclear desalination “nuplexes” have shown them

to be attractive for meeting the drinking water and sanitary needs of populations in high GDP countries. However, even with improvements, desalination does not appear suitable for meeting the massive future water needs for agriculture, and for countries with low GDPs, where most of the world’s population lives.

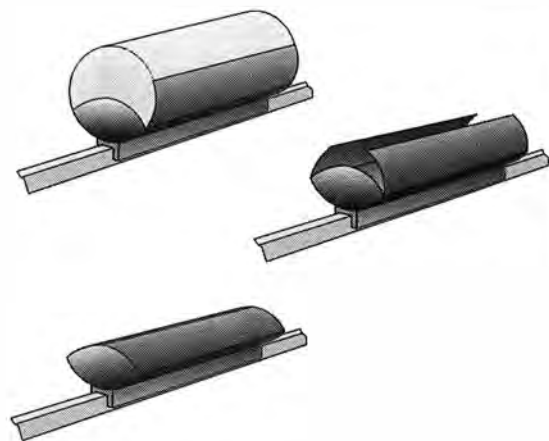
Maglev offers a practical cost-effective way to supply much of the new fresh water needs in the 21st Century. The world has plenty of fresh water to support its present and future populations, but many regions have too little, while others have much more than they need. Using Maglev, fresh water can be transported for hundreds of miles at low cost, from places where it is abundant, to users in locations where it is scarce.

Figure 13 is an artist’s illustration of the Water Train, a Maglev system designed to transport large amounts of water over long distances. The Water Train consists of a long train of joined and levitated Maglev vehicles, each of which has a bladder that holds 50,000 gallons of water. A 200-vehicle unit train would deliver 10 million gallons per trip. Travelling at 200 mph, each Water Train could make four round trips daily, bringing water from a source that was 600 miles away from its users. For shorter travel distances, even more round trips per day could be made. For example, at 300 miles distance, a Water Train could deliver 80 million gallons of water daily, enough for millions of users.

Energy consumption of the Water Train is minimized by three design changes, which distinguish it from the single Maglev-2000 vehicle proposed for passenger and freight transport. First, by joining the Maglev vehicles into a long, streamlined unit train, the air drag per vehicle is greatly reduced, by a factor of 4, compared to an individual vehicle. Second, collapsing the empty bladders for the return trip reduces air drag by another factor of 2, compared to the drag for full bladders during the delivery trip. Third, placing iron plates on top of the narrow-beam guideway generates a strong upwards attractive force on the superconducting magnets that acts to levitate the vehicle. This “iron lift” levitation force has virtually zero magnetic drag losses. The aluminum loops on the guideway now provide vertical and lateral restoring forces around the equilibrium suspension point, rather than levitation. The electric power losses in the aluminum loops (which are given by the product of the

**Figure 13**  
**ARTIST’S DEPICTION OF**  
**THE WATER TRAIN**  
**SYSTEM**

*Each Water Train vehicle has a bladder that holds 50,000 gallons of water. Thus a 200-vehicle unit train could deliver 10 million gallons per trip. A Water Train vehicle with bladder filled is shown at top. For the return trip, the bladders would be collapsed (bottom), in order to reduce air drag.*



square of the loop current multiplied by the electrical resistance of the loop), still generate some small amount of magnetic drag on the Maglev vehicles, but because their time-averaged currents are much less than when they provided the levitation force, the magnetic drag effects are much less.

Delivery by the Water Train is much cheaper and more adaptable to terrain changes than by pipeline. For every 300-foot increase in elevation of a pipeline, for example, water pressure decreases by 150 psi; if elevation decreases by 300 feet, water pressure increases by 150 psi. If there are major changes in elevation, pipelines have to either build bridges or drill tunnels—depending on whether the change is downhill or uphill—or change water pressure using turbines or pumps. In either case, the process is very expensive.

Because of its high speed, the Water Train can follow the rise and fall in terrain with virtually no penalty. On upgrades, the Train slows slightly as kinetic energy is transferred to gravitational energy; on downgrades, the train speeds up slightly as gravitational energy is transferred to kinetic energy. At 200 mph, the Water Train can easily negotiate a 300-foot change in elevation, with a speed change of only 20 mph.

The cost of delivery by Water Train is proportional to distance. Taking into account the amortized cost of the on-grade guideway and the vehicles, plus the energy and other operating costs, the total cost for delivering 1,000 gallons of water over a distance of 600 miles is approximately one dollar. In comparison, just the amortized cost (not including operating costs) for the approximately 600-mile pipeline in Libya—which cost more than \$30 billion to build and delivers 600 million gallons daily—is on the order of \$5 per thousand gallons.

There are many potential routes for Water Trains. In the United States, billions of gallons per day of water could be transported from the Lower Columbia river to California, Nevada, and the rest of the Southwest. In the High Plains region, water could be brought from the Mississippi and Missouri Rivers to Colorado, Texas, Nebraska, and other drought areas. In the Mideast, Turkey has a large water surplus, some of which could help Iraq, Israel, Saudi Arabia, Syria, and other water-short countries in the region.

China has large areas where water is very short, and is considering a \$60 billion canal system to help alleviate shortages.

The proposed canal has raised serious concerns about pollution effects, however. The Water Train eliminates these concerns. There are many other areas in Asia and Africa to which the Water Train could bring much needed water.

Finally, in contrast to pipelines, whose only function is to deliver water, using the Water Train, the same guideway that carries the water-bearing vehicles can also carry passenger and freight vehicles, providing efficient, low-cost, high-speed transport to help raise living standards, as well as bringing the water needed for life itself. The very high transport capacity of Maglev enables this dual usage capability.

### Getting Maglev Moving

In our view, it is inevitable that Maglev will grow and evolve into the major mode of transport in the 21st Century. The benefits that it offers—greater speed, no need for oil, zero pollution, reduced cost for passenger and freight transport, and absence of congestion, will draw more and more users to it.

The real question is, how soon can Maglev make a major impact on transport, and what can be done to speed up the process? Maglev technology is already here. No fundamental new materials or inventions are needed. Rather, Maglev needs operating experience and testing on revenue routes, and engineering development and optimization to lower the construction and operating costs. Governments, particularly in Japan and Germany, have played a key role in developing Maglev, with each spending about \$2 billion. However, their first-generation systems are too expensive and constrained in scope to be widely implemented. We need second-generation Maglev systems, like that of Maglev 2000, which have a lower capital cost and serve a wider market, such as the transport of truck-type freight.

Although reducing the cost of Maglev systems and broadening their capabilities is necessary, it is not sufficient. Government leadership is also needed to make Maglev happen. Ensuring efficient, effective, and affordable transport is a fundamental duty for government. In the past, the U.S. government has always played a major role in vigorously planning for, and implementing, new and better modes of transport. The rapid westward expansion and industrialization of the United States in the last half of the 1800s, was a result of the massive land grants and subsidies to railroads from the government. Similarly, the U.S. Interstate Highway system, on which our material prosperity strongly depends, came into being because the government planned and funded it. Our quality of life would be much poorer without air travel, which enables the rapid movement of people and goods within the United States, as well as globally, but it also would not have happened without massive government funding of airplane development and airport construction.

Governments can help bring about second-generation systems by funding demonstrations of advances in Maglev technology, and by entering into public-private partnerships to build revenue Maglev systems. In this latter role, government should not subsidize systems that are economically non-viable. Instead, government should offer funding incentives to bring about improved, lower-cost Maglev systems that will attract users. For example, the government's contribution to guideway cost could be structured so that as total cost decreases, the government's contribution would increase. This

would be a powerful incentive for engineering improvements that actually lowered cost, rather than a straight subsidy to help prop up an uneconomical system.

It is critically important that governments recognize that developing new, more efficient transport systems like Maglev, which do not need oil, should be a major near-term goal. Oil should be reserved for use as a chemical feedstock. Those countries, like Japan, Germany, and China, which have already started to implement Maglev systems, have the potential to become the world's leaders in this new mode of transport. Maglev will yield enormous benefits, not only from its much lower costs for moving people and goods, and its reduced requirements for expensive energy, but also from the hundreds of thousands of new jobs that it will create. Many of these new jobs will be in companies that manufacture Maglev vehicles and guideways for export to other countries.

Maglev is a transforming technology for transport, as important in its impact as the introduction of ships, railroads, autos and trucks, and airplanes. Just as they transformed humanity's ability for rapid and efficient transport of people and goods, with a corresponding improvement in living standards, so will Maglev.

### References

1. J.R. Powell and G.T. Danby, 1966. "High Speed Transport by Magnetically Suspended Trains," Paper 66-WA/RR-5, ASME meeting, N.Y., N.Y. Also, "A 300 mph Magnetically Suspended Train," *Mechanical Engineering*, Vol. 89, pp. 30-35.  
Further details on the technology and applications of Maglev can be found at [www.maglev2000.com](http://www.maglev2000.com).
2. *The Eurasian Land Bridge—the New Silk Road—Locomotive for Worldwide Economic Development*, by J. Tennenbaum, et al, Executive Intelligence Review (January 1997).
3. A Maglev "Ring Rail" around the top end of Australia, between Melbourne and Perth, is discussed in "The Infrastructure Road to Recovery," Feb. 2002, published by the Citizens Electoral Council of Australia.

### About the Authors

*Dr. James Powell and Dr. Gordon Danby invented superconducting Maglev in 1966, and were granted the first patent in the field. Their original Maglev design is now operating in Japan.*

*Dr. Powell was a Senior Scientist at Brookhaven National Laboratory, where he directed research on fission and fusion reactors, from 1956 until his retirement in 1996. He is the inventor of the compact ultra-lightweight Particle Bed Nuclear Rocket, which was the basis for the Department of Defense/Strategic Defense Initiative programs on Space Nuclear Thermal Propulsion in the 1980s-1990s. In addition to Maglev, he currently is involved with space nuclear propulsion and power systems for planetary exploration, as well as advanced low-cost methods for vitrifying high-level nuclear waste.*

*Dr. Danby was a Senior Scientist at Brookhaven National Laboratory, where he directed research on superconducting magnets and high-energy particle accelerators, from 1957 until his retirement in 1999. He is the inventor of aluminum-stabilized superconducting magnets, and a pioneer in the development of MRI systems—Magnetic Resonance Imagery—for medical diagnostics. In addition to Maglev, he is currently involved in the development of next-generation MRI scanners.*

*Powell and Danby were awarded the Franklin Medal for Engineering for their Maglev invention in April 2000 (previous recipients included Nikolai Tesla and Charles Steinmetz). Maglev 2000 of Florida is developing their advanced second-generation Maglev system to carry passengers and trailer trucks.*

# All You Need to Know to Prove The Renewable Energy Economy Is a Hoax

by Greg Murphy

**The Solar Fraud: Why Solar Energy Won't Run the World**

by Howard C. Hayden  
 Pueblo West, Colo.: Vales Lake Publishing, 2001  
 Paperback, 220 pp., \$21.95

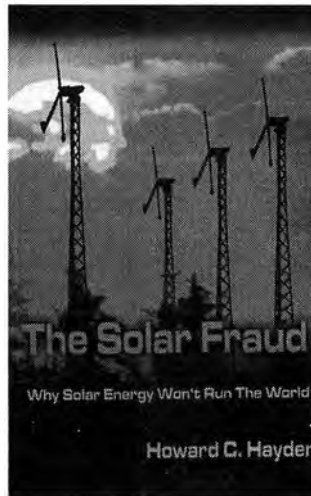
When I was given this book to review, I wondered if it was just another disorganized effort to show that solar energy is not the stuff that dreams are made of. I was thoroughly surprised, and pleased, to find a book that attacks solar energy on the basis that it can never supply the amount of energy needed to power an industrial economy—and that it does so with humor.

Author Howard C. Hayden points out correctly that most books on solar energy and most textbooks on economics do not even cover the topic of energy, except to mention it in relation to cost. The idea that energy is important only in terms of cost, and not in its relationship to the level of development of society, is totally disconnected—and totally insane.

To demonstrate this relationship, Dr. Hayden gives a short overview of energy use, and how it is tied to economic advancements in the United States. For the first 100 years, we produced our energy from the burning of coal and wood. Prior to 1850, the main source of energy was firewood, with coal used primarily for industry and railroads. After 1880, the use of wood as a source of energy was reduced; coal became the dominant energy source, and remained so until the petroleum era. Only in the recent period, have we added nuclear energy, although only in a small way; nuclear is 20 percent of the electrical power produced by utilities, but 18.6 percent of all electrical production combined.

**Renewable Energy Is a Hoax**

The “fraud” the author refers to in the book’s title, is the hucksters who claim that that solar and other so-called renewable energies are the answer to the energy needs of the world. Such



hoaxsters use fake accounting and media hype to make their claims.

Part of the faking of the numbers is done by stating that a certain amount of capacity is going to be installed, with the implication that capacity equals output. But there is a big difference between the capacity installed and the amount of energy produced. The capacity factor—the percentage of energy produced from the amount of capacity installed—runs between 20 to 35 percent with the so-

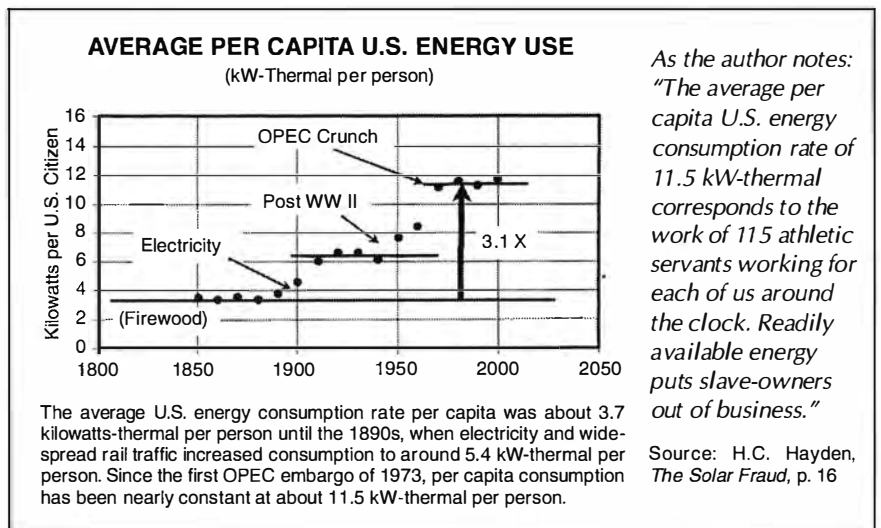
called renewables.

As an example, let us take a look at the stated “capacity added” for wind energy in the 1990s: around 5,000 megawatts a year worldwide. But, the round-the-clock average power output is about 30 percent of that figure, if you are lucky. That comes to only about 1,500 megawatts a year of growth in wind energy production—compared to the 5,000 megawatts claimed. This is about 15 percent of the annual average growth in energy production from nuclear power plants. Only a professional obfuscator could make an annual increase of 9,900 megawatts in steady nuclear power look puny compared to 1,500 megawatts of stochastic wind power.

**Non-renewable ‘Renewables’**

Dr. Hayden systematically exposes the hoax of renewable energy by showing that in every case of wind, solar, biomass, and so on, there is not even enough energy produced to produce the source again! In other words, a wind turbine cannot produce enough energy to produce another wind turbine (because of the large amount of electricity needed to smelt the aluminum).

The author devotes one chapter each to



the solar-based renewable energies, in order to give the reader a full, realistic account of the energy density that can be produced by each of these sources—as opposed to the media hype about planned capacity, or some other fairy tale.

The common feature of the renewables is that each of these energies *can work* for a niche problem in a particular, special environment. For example, there are Western ranches in locations where well water is too deep to be brought to the surface by the old-fashioned wind turbine. They will need electric pumps, yet power lines are very distant, and solar power is ideally suited to the task. In this case, the problem can be solved either by solar cells, or a modern wind turbine fitted with an electric generator. But neither solution for this particular problem has the juice to power an increasingly developing industrial economy.

The intrinsic inability of solar energy “to run the world” (to use the author’s phrase), makes ludicrous the current drive to promote renewables as a way to ensure national energy security in the aftermath of Sept. 11, 2001. The Director of the National Renewable Energy Laboratory, Admiral Richard Truly, for example, called for the development of ethanol, solar, biomass, and wind as the way to achieve “energy security.”<sup>1</sup> The idea that the United States could become “energy secure” by burning wood chips and using sunbeams, instead of fully funding advanced, energy-dense technologies, like nuclear and fusion, is ridiculous—unless one admires cavemen.

#### The ‘Civilization Stinks Crowd’

Some of the loudest cheerleaders for the development of solar and other renewable energies are the crowd around Amory Lovins and Paul and Anne Ehrlich, whom Dr. Hayden has aptly called the “civilization stinks crowd.”

To give an example, and a very telling one, Lovins says that it is morally wrong to use energy, and, furthermore, “for over 90 percent of energy uses, electricity is an indefensible luxury.” Lovins himself is opposed to having any abundant source of energy. He says: “If nuclear power were clean,

safe, economic, assured of ample fuel, it would still be unattractive because of the political implications of the kind of energy economy it would lock us into.”

In other words, the world doesn’t deserve to have the “attractive” lifestyle of enough power to light, heat, or cool its homes and schools, run its industries, and so on.

Another example of the anti-human thrust of this solar and renewable energy crowd is from the “small is better” team of Paul and Anne Ehrlich: “Over the next decade or two, Americans should try to cut their per capita energy consumption in half. Nothing less than a reorganization of the American way of life is required.”

This crowd of anti-human neo-Malthusians preach to the developing countries, that they should use the sunbeams and chicken manure they’ve always had, because anything more would be “uncivilized.”

As for “conservation” as an energy

source, another favorite theme of the Malthusians, the author makes the point that conservation is not a source of energy, just as being on a diet is not a source of nutrition. Dr. Hayden challenges anyone to lock himself or herself in a well-insulated, empty room and use every known method of “conservation” to fill a shot glass with gasoline.

#### A Complete Reference Guide

The energy conversion charts included in the book, makes it a complete reference guide, giving readers the facts on renewable energy questions and the way the experts twist numbers. The charts are important, because another of the ways the fraud is maintained is through the willful use of different units of measure in the same press release or article. The charts in the back of this book will be of great help to readers in figuring out the coded figures into something that the reader could understand and not be confused.

In one of the charts, Dr. Hayden gives the heat content of fuels, so that they can be compared. For example, take the number of kilograms of coal and multiply that by 24.1 times  $10^6$  to get the amount of joules of heat by mass. For a kilogram of dry biomass, you multiply by 15 times  $10^6$ . Another chart gives a table of the amount of solar intensity by land area. For example, at noon in the tropics with clear skies, the solar intensity at the surface of the Earth is 950 watts per square meter, but in Hartford, Conn., the solar intensity is only 160 watts per square meter.

The appendix also contains a short paper on how to determine the efficiency of a heat engine, which provides readers with another way to expose the lies used to promote solar and other renewables.

To sum up: I would highly recommend this book for people who want a better understanding of the renewable energy questions, presented with a good sense of humor.

#### Notes

1. This is from a March 14, 2002 speech given at the National Press Club by Admiral Richard H. Truly, Director of the National Renewable Energy Lab, titled “New Energy Systems Enhance National Security.”



H. Hayden, *The Solar Fraud*

*“A wind turbine cannot produce enough energy to produce another wind turbine.” Here, one of several collapsed wind turbines at Altamont Pass in California, July 2001.*

# David Lasser: A Distinctly American Space Pioneer

by Marsha Freeman

---

## The Conquest of Space

by David Lasser

Ontario, Canada: Apogee Books,

2002 [reprint from 1931]

Hardcover, 191 pages, \$21.95

---

David Lasser's contribution to the space age was brief and very early in the era of space exploration, but was of lasting significance. In 1931, Lasser wrote the first book in the English language on the possibilities for the exploration of space. Apogee Books has done a great service in reprinting this work, bringing back to life this extraordinary pioneer.

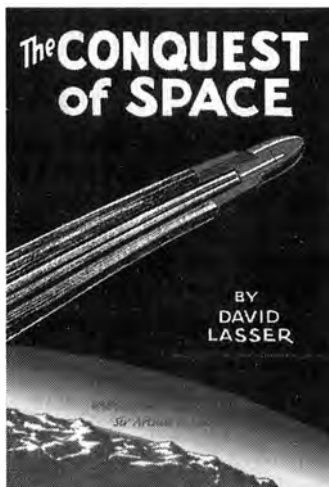
What is most striking about David Lasser, is that *The Conquest of Space* is but one contribution he made to projects whose aim was the betterment of mankind. Lasser did not make rocket research his life's work; he put aside his fascination with space in order to intervene in the desperate moral and economic situation around him during the Great Depression.<sup>1</sup>

Lasser's professional association with space exploration ended only three years after the publication of *The Conquest of Space*. But the book inspired young people in the United States and in England, to dedicate their lives to this infant space endeavor. As the founding president of the American Interplanetary Society in 1930, Lasser led the effort to spread the word to the English-speaking world that rocket experiments were already under way in Germany, Russia, and the United States.

Like other early pioneers, Lasser suffered the humiliation of being called a "nut," because he believed man would one day make trips to the Moon and the planets. More like his German colleagues Oberth, Willy Ley, and von Braun, and unlike the reclusive American Robert Goddard, Lasser chose to defend his ideas, regardless of public ridicule. He paid the political consequences for the rest of his life.

---

Illustrations are from *The Conquest of Space* by David Lasser (Ontario, Canada: Apogee Books, 2002)



David Lasser was born on March 20, 1902, in Baltimore, to parents who were Russian immigrants. His mother was a leader in Jewish welfare work in New Jersey, and active in many philanthropic activities. Lasser did not complete high school, but went to work to help support his family, and although under age, he volunteered for the American Expeditionary Forces and fought in World



David Lasser (1902-1996). Although his involvement in space exploration ended only three years after the publication of *The Conquest of Space*, his work inspired a generation of future space scientists and engineers.

War I.

After the war, Lasser studied electrical engineering at the Newark College of Engineering, and he completed a Bachelor of Science degree at the Massachusetts Institute of Technology in 1924. He then held a variety of jobs, including one with the New York Edison Company (where, historian Michael Ciancone reports, Lasser was fired for protesting the dismissal of several employees on the basis of time-motion study results). In 1929, he became the managing editor of *Science Wonder Stories* magazine, published by Hugo Gernsback.

### American Interplanetary Society

In this new position, Lasser became interested in the possibilities of using rockets for space travel. He also sought to encourage writers to base their fictional stories more on science than on fantasy. With a handful of other writers, Lasser founded the American Interplanetary Society (AIS) on April 4, 1930, as a means to "enlarge man's intellectual and spiritual life." It was inspired by the German Society for Space Travel, which had been founded in 1927 by writer Willy Ley and amateur rocket enthusiasts.

The purpose of the German Society was not only to carry out experiments, but to spread news of those developments around the world, toward an international effort to propel man into the space age.<sup>2</sup> The American Interplanetary Society, under Lasser's guidance, dedicated itself to similar aims. Lasser thought, as did Willy Ley, that the scientists engaged in research needed a group of supporters to promote their case to the lay public, in order "to spark the country into believing that space travel was feasible," Lasser wrote in 1981.

That Lasser believed this effort should be worldwide, is indicated by the fact that in 1931, he and French astronautics pioneer Robert Esnault-Pelterie wrote a letter to Hermann Oberth, lobbying for the formation of an International Commission for Astronautics. Although such an organization became less and

less likely as the world suffered through the Depression and later careened toward World War II, the 1950 founding of the International Astronautical Federation fulfilled Lasser's dream of an effort on the part of all mankind.

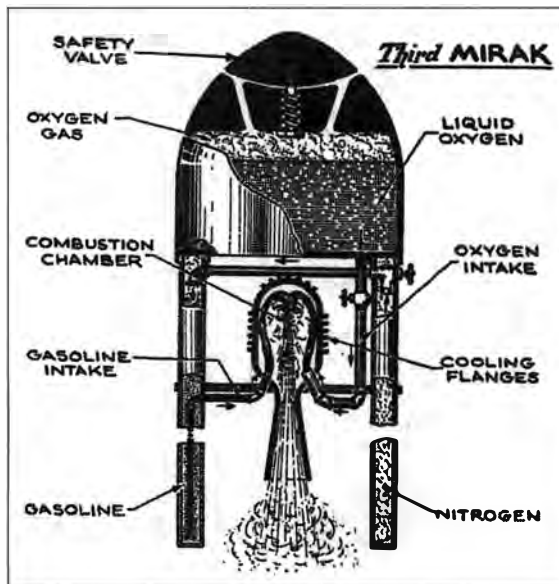
Soon after its formation, the American Interplanetary Society began publication of the *Bulletin* magazine, edited by Lasser, which published translations of papers and reports from Europe, and communications with the German Society for Space Travel. Although severe economic conditions dictated that only a handful of the most committed would become dues-paying members of the AIS (it had no more than 300 members until 1941), there was quick confirmation of the American public's excitement and interest in space travel.

In its first issue, the *Bulletin* announced that Esnault-Peltiere would speak at the American Museum of Natural History, to be followed by excerpts of the 1929 German film, *Woman in the Moon*. More than 2,000 people showed up at the auditorium, and the program had to be repeated, to accommodate those who had waited outside for two hours to hear about space travel.

### **The Conquest of Space**

Likely encouraged by this overwhelming response from ordinary citizens, and already having delved into the science of rocketry, Lasser wrote *The Conquest of Space*. Unable to find a publisher, the members of the American Interplanetary Society combined their personal resources, and published it themselves. It was quickly sold out.

In the preface to the book, David Lasser states that the purpose of the work is "to present the background of the program for the utilization of the rocket—not only as a revolutionary means of

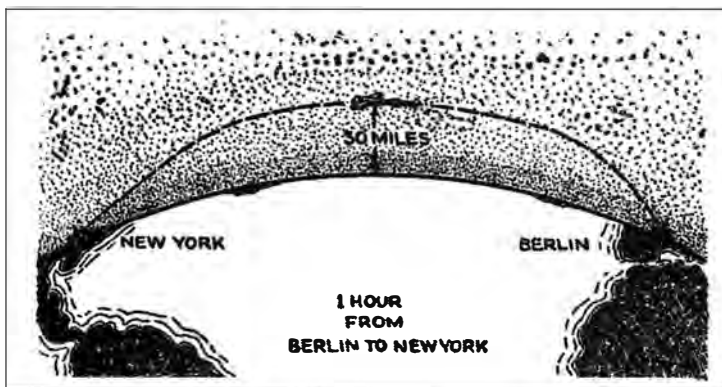


*The American Interplanetary Society followed closely the progress of its compatriots in Germany, who, in 1930, were testing their liquid-fueled Mirak, or Minimum Rocket.*

terrestrial transportation (which shall bring Europe and America within one hour's journey of each other), but also for the conquest of the planets. . . ."

"It is hoped by this presentation of the future of rocket flights in the Earth's atmosphere and in interplanetary space that the mists of misunderstanding, ignorance, and prejudice that surround the 'interplanetary rocket' question may be cleared up," Lasser states hopefully.

Lasser reviews the history of rocketry and the fundamental questions yet to be answered to make this ancient technolo-



*In the 1930s, it was assumed that the first use of rocket technology would be to carry mail and passengers, across the United States, and then between Europe and America, but this was never found to be practical.*

gy applicable to the future of exploration. He then describes, in a style Michael Ciancone refers to as "speculative non-fiction," the space ship that is ready to fly to the Moon.

Lasser's journey, however, is different from the Apollo program, nearly 40 years later, in that in Lasser's account, the "great nations" have "agreed to abandon the race to reach the Moon, and pooled their knowledge, skill, and resources." The result, he asserts, is that "races unable to settle amicably their political and social difference had received from their scientists a striking lesson in international co-operation."

The 10,000-ton ship, which cost \$100 million, is ready to ascend, carrying the crew, passengers, and "the accessories that we have tried desperately to reduce to the 10 pounds allowed each of us." Lasser provides a colorful description of the journey, how to eat in weightlessness, the particulars of the rocket propulsion system, and what the scientists will learn from their mission to the Moon.

Lasser began his study of rocket science when he found that previous generations of fiction writers had either relied upon fanciful and unworkable techniques for getting their travellers into space, or glossed over the problem entirely. In his book, he describes the possibility of using atomic energy, and magnetic rails, as well as advanced chemical rockets. He reports that, according to "one of Britain's most eminent men of science . . . the utilization of the complete atomic energy of a pound of matter would be sufficient to transport a 500,000-ton spaceship from the Earth to the Moon, and return!"

In a remarkable discussion for that time, Lasser entertains a question that has become, once again, of keen interest today. In a chap-



This 1930 drawing of the trajectory astronauts would take from the Earth to the Moon is very familiar, in that it is the figure "8" employed nearly 40 years later in the Apollo program.

ter titled "New Worlds," he considers the possibility, and discusses the prerequisites, for life to exist on other planets.

Lasser reviews the seven conditions that astronomer Harlow Shapley had outlined for extraterrestrial life, all of which stand the test of time. Lasser then discusses how the known conditions of each of the planets of the Solar System compare to these requirements. Based on the limited knowledge extant at that time, Lasser concludes, "we find remaining in the list of possible worlds for exploration, and the possible existence of natural life forms, only Venus and Mars." He states in a footnote that "the moons of the major planets have not been considered, for we know absolutely nothing about their surfaces. This is true also of the asteroids and of the planet Pluto."

#### The Rewards for Science

The conquest of space, to David Lasser, was not the planting of flags or even just the economic/technological spin-offs from the great effort, but great scientific and astronomical projects:

"The benefits to science of an exploration of Mars, Venus, and possibly of the moon will for obvious reasons precede any others," Lasser writes. "The first and surest of these scientific rewards will go to the astronomer. . . . Conclusions reached from our position, under the blanket of terrestrial atmosphere, could then be checked on the airless moon or nearly airless Mars. We need no longer suffer the disadvantages of the 'fixed observer.' We could if necessary carry our observations on three planets simultaneously, and verify beyond doubt conclusions reached only on Earth."

For example, he explains, "the use of a telescope on Mars, 40,000,000 miles farther from the Sun than the Earth, should certainly aid tremendously in these discoveries. . . . To both the world of astronomy and the public at large, eager to know the domain of the little corner of the universe that is our solar system, the interplanetary voyage is recommended."

Not only the astronomers will reap a harvest, Lasser said. Biologists and

those concerned with the origin and development of life will be "concerned with cosmic verities," as they may find life elsewhere that is different from life here, as well as the confirmation of universal principles that are present everywhere.

The chemists and physicists will be able to study "matter and its nature and possibilities not only on other worlds, but in space itself," Lasser suggests. "Certainly our own knowledge of nature is pitifully small. It is inconceivable that discoveries on other planets would not add greatly to it."

Lasser's final chapter, "A Glimpse of the Future," looks ahead to the year 1950, where "one may confidently envision long-distance rocket-planes engaged in regular flights over the far places of the Earth." This will be possible, he proposes, because "the technical problems of controlling rocket fuels should be successfully overcome within five years." In 25 years, there should be sufficient time "for the training of pilots and navigators" in the operation of rocket-planes.

Keeping in mind that this was written in 1931, it is of interest that Lasser sees that rocket-planes may be adopted by military men for warfare. "Two hours after a war has been declared a combatant nation might without warning find its cities bombarded by a fleet of rocket-planes."

"The rocket of 1950," he concludes, "may then be an agent of great good and of equal harm. . . . By the creations of our hands and our brains we have accomplished our difficult climb from savagery to our present civilization. By such a creation as the rocket, aided by our own willfulness, we may fall just as swiftly back to savagery. . . . On the other hand, we know that the rocket opens new worlds immeasurably vast in their promise. Barring accident, or a catastrophic war, the man of the future should see, at least in part, the realization of that promise."

#### David Lasser and FDR

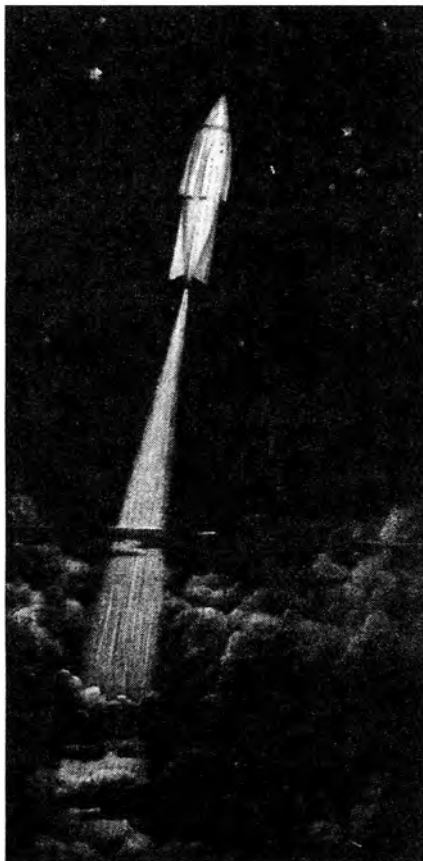
As excited as David Lasser was about the coming age of space flight, he was also imbued with a sense of social responsibility and commitment to the general welfare, undoubtedly



from his upbringing. In an interview with a reporter from the *Baltimore Sun* in 1980, Lasser stated that in the 1920s, he worked at a nearby settlement house to help unemployed Italian workers.

He became involved in socialist politics from the time of the Sacco-Vanzetti case, and attended lectures by Norman Thomas, focussing his efforts on the plight of the millions of people out of work. "Unless we solved the problem of the unemployed, all else would be academic," he stated. He was fired as editor of *Wonder Stories* because of his political activity, and he resigned from the American Interplanetary Society in 1933, to form a local union for the unemployed. In 1935, this became the Workers Alliance of America, WAA.

In 1940, he left the WAA, opposed to



David Lasser's 1931 book was the first in the English language to propose a scientifically practical means to travel into space, and he lived to see it take men to the Moon, and their spacecraft to the planets.

the growing influence of the Communist Party in the organization, and formed the American Security Union. With war under way in Europe, and on the horizon in the United States, Lasser proposed to President Franklin Roosevelt that a large program be created to provide the unemployed with the skills and training needed to support the industrial war effort. The President accepted the proposal, and asked Lasser to join the program as a consultant. The Congress also accepted the proposal but, as Ciancone reports, it blocked Lasser's appointment as a consultant, "with one Congressman denouncing Lasser from the floor of the House as 'not only a radical but a crackpot with mental delusions that we can travel to the moon.' "

Finally, Lasser took a job as a labor consultant with the War Production Board for the duration of the war. In 1948, he was asked to join the effort to rebuild Europe through the Marshall Plan, reportedly to help counter the influence of the Communist parties in the labor movements overseas. He served for only three months, when again the Congress would not approve his appointment. The FBI had listed the Workers Alliance of America as a radical organization.

From 1950 until 1969, when he retired, David Lasser was the Economics and Research Director for the International Union of Electrical Radio and Machine Workers. In 1980, he finally received a letter of apology from President Carter, clearing his name, which stated that he had been "treated unjustly."

David Lasser never lost interest in space. Upon retirement, he once again became actively involved, and during the 1980s worked on a book called *The Cosmic Adventure*, which was not completed. He travelled and met with astrophysicists around the country, and participated in an overnight session at the Palomar Observatory. He studied various theories on the origin of the universe, and the philosophical implications of quantum mechanics, relativity, and cosmology.

Twenty-five years before the Soviet Union had started the space age when it launched Sputnik, David Lasser presented the first Annual Report to the

American Interplanetary Society on April 13, 1931. He concluded his remarks, which outlined an ambitious program of research, experimentation, international collaboration, and public education about astronautics, stating, "I think that despite the enormous difficulties that must be leveled before a successful space flight can be made, that it will be accomplished within the lifetime of all of us. We should all feel a great enthusiasm for our work in helping to make it a dream come true."

And they did.

#### Notes

1. Historian Michael Ciancone and Amelia Lasser, David Lasser's wife, have compiled a biographical sketch of this unusual man ("David Lasser—An American Spaceflight Pioneer"), which was presented at the 53rd International Astronautical Congress in Houston in October 2002.
2. M. Freeman, 1993. *How We Got to the Moon: The Story of the German Space Pioneers*. (Washington, D.C.: 21st Century Science Associates).

## INFINITE ENERGY MAGAZINE

New Energy • New Science



Sample Copy of Current Issue

\$5.95 North America/\$10.00 Foreign

Subscription (6 Issues)

\$29.95 North America/\$49.95 Foreign

Contact us for our catalog of books, videos and other products, or visit our website.

New Energy Foundation, Inc.

P.O. Box 2816-TF

Concord, NH 03302-2816

Phone: 603-228-4516 • Fax: 603-224-5975

<http://www.infinite-energy.com>

# A New Look at the Night Sky

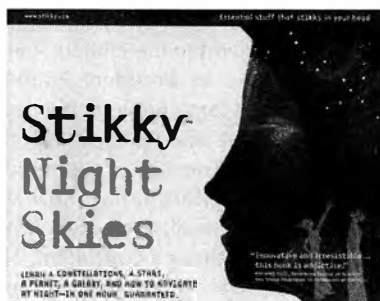
## Sticky Night Skies

New York: Laurence Holt Books, 2003  
Paperback, 234 pp., \$12.00

This book attracted me, in spite of its infantile title, because it starts with some hubris, promising that we can “learn 6 constellations, 4 stars, a planet, a galaxy, and how to navigate at night—in one hour, guaranteed”!

Oh, I do not intend to praise this book to the skies; its method is simple and sequential, and it has no astronomy in it. However, the small challenge posed by identifying the constellations, might keep some people turning the pages, and then they will no longer be as befuddled as most, when looking at the night sky. That’s good!

It works this way. You look at a photograph of the night sky, and you see nothing but dots. Then, the book helps you to see certain patterns, gestalts, constellations. Then you turn the page again,



still bewildered, but less so. Then, the book presents the next challenge . . . and you can go back and forth with the unmarked pages, the marked pages, and the night sky itself.

That’s all good. Unfortunately, we do not have enough planetaria (that play classical music instead of rock garbage), which are much better at familiarizing people with the night sky than this book is. And we ought to have friends who can help us with this task, but most of us do not, because our cultural Titanic has gone down. So we

grasp at flotsam and jetsam to keep us afloat. I advise that you buy this piece of flotsam, along with H.A. Rey’s book *The Stars: A New Way to See Them*, and you will not have wasted your money.

But *think* about this, while you’re looking for the constellations: Imagine a new Renaissance, where teenagers are mastering the Fundamental Theorem of the young Carl Gauss, the work of Kepler. Utopian? The LaRouche Youth Movement has already started to do this!

And imagine this: Suppose that every yard in the country, instead of a TV dish mainlining porno fantasy and pro-war propaganda, had radio (or other) telescopes instead, where kids would playfully educate their parents, in what those images might mean for our colonization of space, and getting out of the confines of this tiny solar system?

—Rick Sanders

## CHALLENGES OF HUMAN SPACE EXPLORATION

SPRINGER PRAXIS SERIES IN ASTRONOMY AND SPACE SCIENCE

by **Marsha Freeman**

Associate Editor, *21st Century Science & Technology*

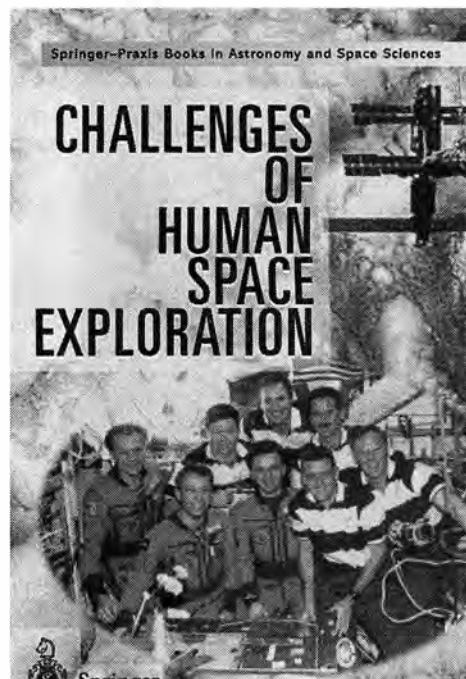
The real story of the accomplishments of the United States and Russia aboard the Mir space station.

Foreword by Dr. Michael DeBakey.

300 pages, illustrated

**SPECIAL DISCOUNT FOR \$30**  
**21st Century readers**

(list price \$45)



Mail check or money order (U.S. currency only) to:

**21st Century Space Books** P.O. Box 1951, Dept. T, Leesburg, VA 20177



NASA

Artist's conception of the International Space Station, after all assembly is completed.

# Expand your world view with

## 21<sup>st</sup> CENTURY SCIENCE & TECHNOLOGY

### Subscriptions

U.S.—6 issues for \$25

Foreign—6 issues for \$50

### Books

*The Holes in the Ozone Scare:  
The Scientific Evidence  
That the Sky Isn't Falling*

by Rogelio A. Maduro and  
Ralf Schauerhammer

\$15 each, plus \$3 shipping

OR \$10 postpaid with a subscription

*How We Got to the Moon:  
The Story of the German Space  
Pioneers*

by Marsha Freeman

\$15 each, plus \$3 shipping

OR \$10 postpaid with a subscription

*Global Warming:  
The Rest of the Story*

by Dr. Gerd Weber

\$11 each, postpaid

OR \$8 postpaid with a subscription

*Hermann Oberth:*

*The Father of Space Flight*

by Boris V. Rauschenbach

\$15 each, plus \$3 shipping

OR \$12 postpaid with a subscription

### Give 21st Century subscriptions and gifts

#### ORDER FORM

Enclosed is \$ \_\_\_\_\_ for:

\_\_\_\_ 6 issues/ U.S.— \$25

\_\_\_\_ 6 issues/ foreign airmail—\$50

\_\_\_\_ 12 issues/ U.S.—\$48

\_\_\_\_ 12 issues/ foreign—\$98

\_\_\_\_ \$10 for *The Holes in the Ozone Scare* with a subscription

\_\_\_\_ \$18 postpaid for *The Holes in the Ozone Scare*

\_\_\_\_ \$10 for *How We Got to the Moon* with a subscription

\_\_\_\_ \$18 postpaid for *How We Got to the Moon*

\_\_\_\_ \$8 for *Global Warming* with a subscription

\_\_\_\_ \$11 postpaid for *Global Warming*

\_\_\_\_ \$12 for *Hermann Oberth* with a subscription

\_\_\_\_ \$18 postpaid for *Hermann Oberth*

Please print or type name and address of gift recipients on a separate paper. Gift cards are available.

Note: Back issues are available at \$5 each (\$8 foreign)

Name \_\_\_\_\_

Address \_\_\_\_\_

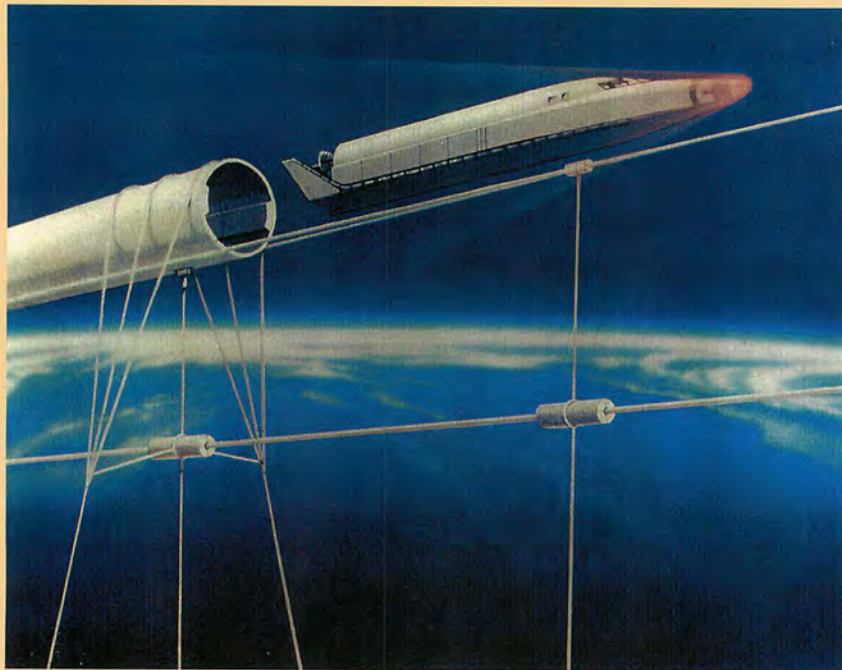
City \_\_\_\_\_ State \_\_\_\_\_ Zip \_\_\_\_\_

Daytime telephone ( \_\_\_\_\_ ) \_\_\_\_\_ e-mail \_\_\_\_\_

Send check or money order (U.S. currency only) to:

**21st Century**, P.O. Box 16285, Washington, D.C. 20041.

[www.21stcenturysciencetech.com](http://www.21stcenturysciencetech.com)



## RIDING MAGLEV INTO SPACE

The inventors of the superconducting magnetic levitation concept describe how it will revolutionize transport in the next decades. In "Maglev: The New Mode of Transport for the 21st Century," scientists James Powell and Gordon Danby describe the many uses of superconducting maglev, from high-speed railroads for passenger and freight, to underground evacuated tubes that would permit train runs from New York to Los Angeles in 1 hour, to water trains, to space launches.

*Artist's illustration of StarTram, a magnetically levitated low-pressure tube, which can guide spacecraft into the upper atmosphere.*

## IS THERE A UNIVERSAL ORDERING PRINCIPLE?

In "The Elements, the Solar System, and the Prebiotic Principle," Laurence Hecht examines the significance of the correspondence of Kepler's geometric ordering of the planetary orbits, with the nuclear model of the physical chemist and Manhattan Project veteran Robert J. Moon.



Illustration by Christopher Sloan

*In the Moon model of the nucleus, the vertices of the cube, octahedron, and icosahedron (nested in that order), represent the protons of the most abundant elements of the Earth's crust and meteors—oxygen, silicon, and iron. Here, the octahedron, as it is nested within the icosahedron.*

## KEPLER'S PLATONIC CRYSTALLOGRAPHY

Modern science rests on two great pillars of Johannes Kepler's genius: the Platonic ordering of the macrocosm, which led to Kepler's discovery of the principle of universal gravitation, and the Platonic ordering of the microcosm, which gave us crystallography. In "Six-Cornered Snowflakes and Five-fold Symmetry," Ralf Schauerhammer gives us an incisive look into Kepler's method.



*Although every one is different, the snowflake invariably shows the six-fold symmetry. Why?*